

REV.	DESCRIPTION	DRAWN	DATE
1	INITIAL RELEASE	FROS	2020/06/10

SPECIFICATION:

1. Current Rating: 2A/ 5A per pin (see P2. table)
2. Contact Resistance: 10mΩ
3. Insulation Resistance: 100MΩ
4. Dielectric Withstanding Voltage: 500VAC
5. Durability: 1000 Cycle
6. Operating temperature range: -40°C~+85°C
7. Storage temperature range: -40°C~+85°C
8. Waterproof: IP67

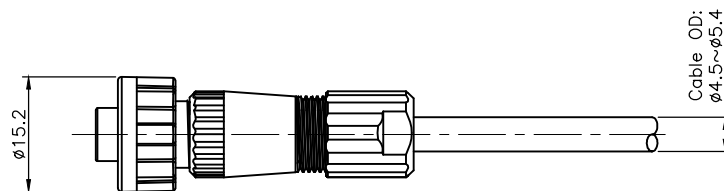
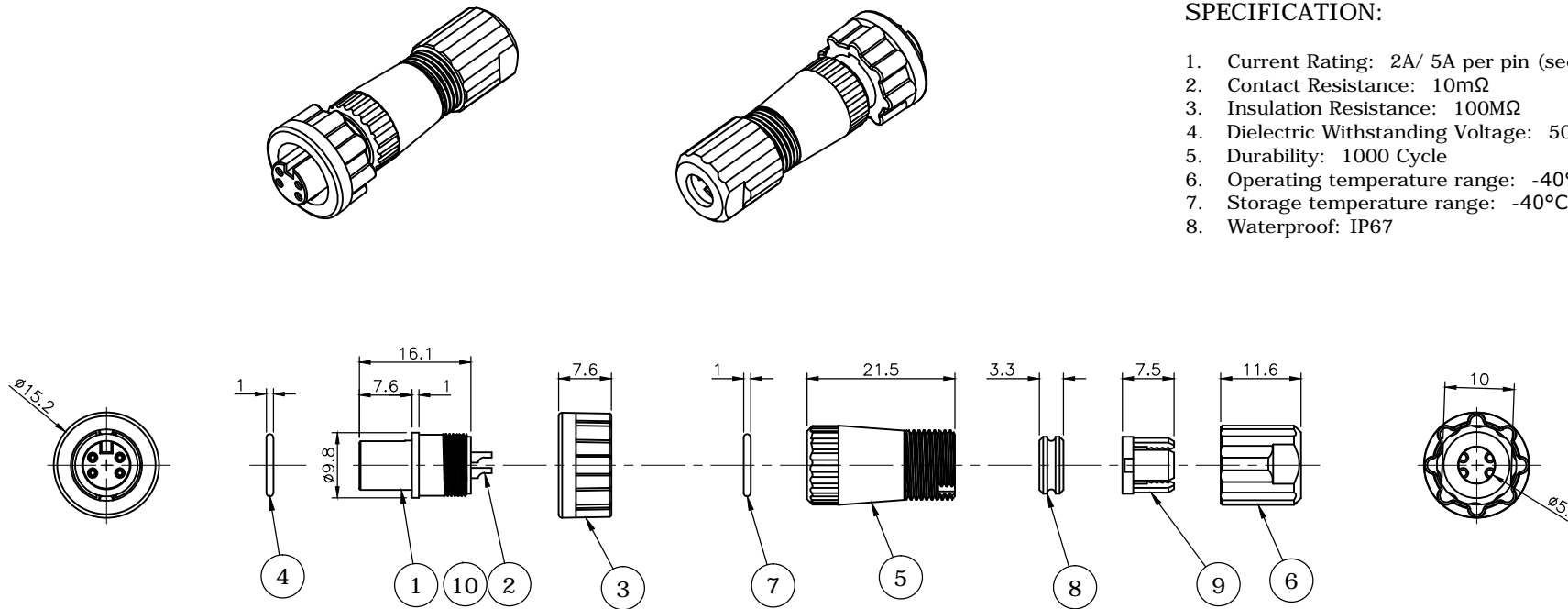

A size connector, field installable cable lock bayonet, female socket female pin, solder bucket

10	GLUE	EPOXY
9	CLAW	PA66, White
8	GASKET	Silicone, Gray
7	ORING-2	Silicone, Gray
6	SEALING NUT	PA66, UL94V-0, Black
5	CABLE GLAND BODY	PA66, UL94V-0, Black
4	ORING-1	Silicone, Gray
3	LOCK NUT	PA66, UL94V-0, Black
2	CONTACT	Brass, 1u" Min. Gold Plating over Nickel
1	HOUSING	PA66, UL94V-0, Black

NO.	PART NAME	DESCRIPTION	
UNLESS OTHERWISE SPECIFIED TOLERANCE			
UNIT:	DECIMAL	LINEAR	ANGLES
	X.	±0.50	±5°
	X.X	±0.25	±3°
	X.XX	±0.12	±1°
 www.attend.com.tw			
DRAWN	Fros	2020/06/10	
CHECKED	Tim	2020/06/10	
APPROVED	Ken	2020/06/10	
SCALE	1/1	SHEET 1/3	
SIZE	A4		
DRAWN NAME:	A Size Connector, Field Installable Lock Bayonet, F Skt F Solder Pin		
PRODUCT NO.	see page 2 table		
FILE NAME	227A-AFFO_B_1		

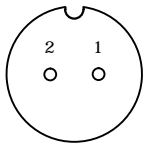
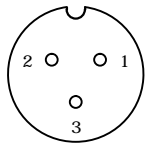
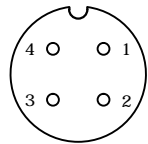
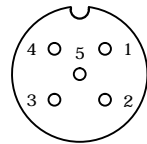
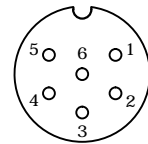

REV.	DESCRIPTION	DRAWN	DATE
	SEE SHEET ONE		

TABLE: Pin Count/ Pin Assignment/ Current Rating/ Part Number

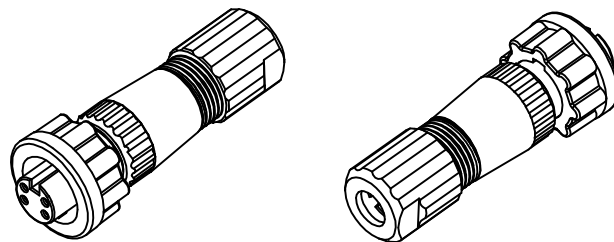
Part Number	227A-02F01	227A-03F01	227A-04F01	227A-05F01	227A-06F01
Pin Assignment					
Pin Count	2Pin	3Pin	4Pin	5Pin	6Pin
Current Rating	5A	5A	2A	2A	2A



Drawing Number: 227A-AFF0
 Description: A size connector, field installable
 cable lock bayonet, female socket
 female pin, solder bucket

UNLESS OTHERWISE SPECIFIED TOLERANCE				 www.attend.com.tw
UNIT:	DECIMAL	LINEAR	ANGLES	
mm	X.	±0.50	±5°	
	X.X	±0.25	±3°	
	X.XX	±0.12	±1°	
DRAWN	Fros	2020/06/10	DRAWN NAME:	
CHECKED	Tim	2020/06/10	A Size Connector, Field Installable Lock Bayonet, F Skt F Solder Pin	
APPROVED	Ken	2020/06/10	PRODUCT NO. see table	
	SCALE 1/1	SHEET 2/3	SIZE A4	FILE NAME 227A-AFF0_B_1

REV.	DESCRIPTION	DRAWN	DATE
	SEE SHEET ONE		

1. Pre-assembled connector

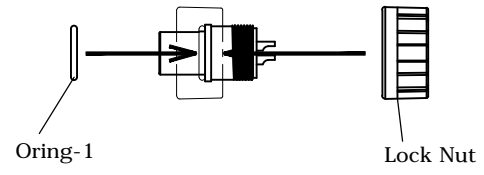

2. Pre-assembled cable gland

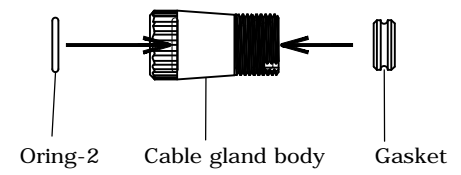

3. Assemble cable gland parts before wire processing in the sequence of pictures than soldering wire

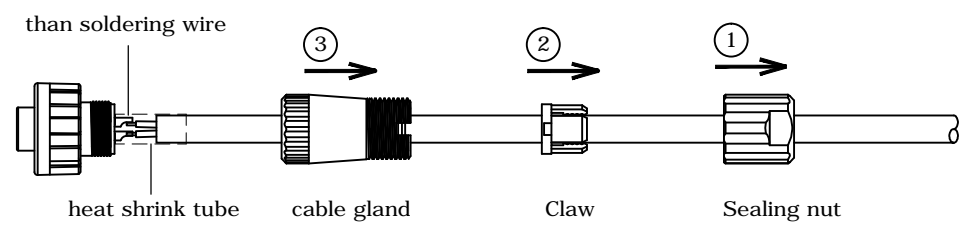

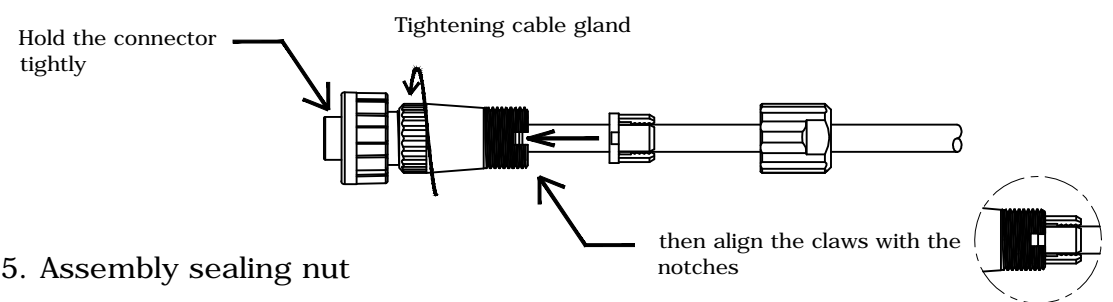

4. Assembly clamp gland

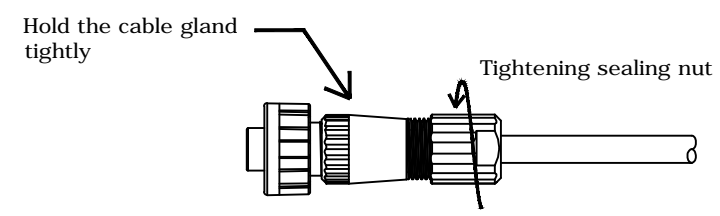

5. Assembly sealing nut



UNLESS OTHERWISE SPECIFIED TOLERANCE				 www.attend.com.tw
UNIT:	DECIMAL	LINEAR	ANGLES	
mm	X.	±0.50	±5°	
	X.X	±0.25	±3°	
	X.XX	±0.12	±1°	
DRAWN	Fros	2020/06/10	DRAWN NAME:	
CHECKED	Tim	2020/06/10	A Size Connector, Field Installable Lock Bayonet, F Skt F Solder Pin	
APPROVED	Ken	2020/06/10	PRODUCT NO. see p/n table	
	SCALE n/a	SHEET 3/3	SIZE A4	FILE NAME 227A-AFFO_B_1

REV.	DESCRIPTION	DRAWN	DATE
1	INITIAL RELEASE	FROS	2020/06/10

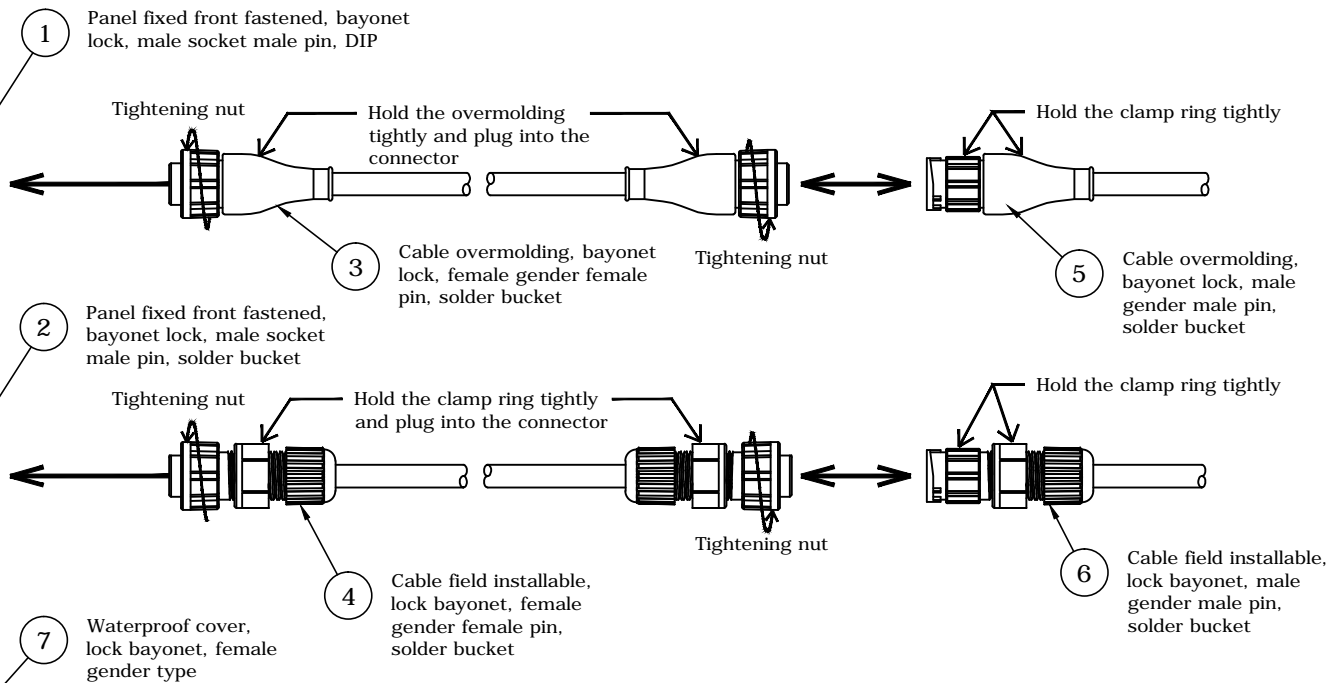
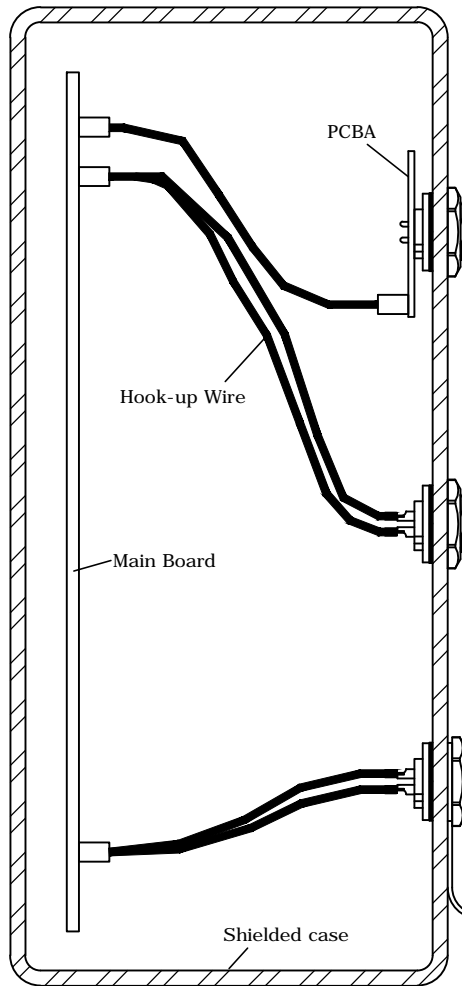

Application	Ball no.	Drawing Number	Gender		Matchable drawing numbers			
			Conn. type	Pin type	1	2	3	4
Panel Fixed	①	227A-DMMO	Male	Male	227A-MFFO	227A-AFFO	227A-0001	
	②	227A-SMMO			③	④	⑦	
Cable	③	227A-MFFO	Female	Female	227A-DMMO	227A-SMMO	227A-MMMO	227A-AMMO
	④	227A-AFFO			①	②	⑤	⑥
	⑤	227A-MMMO	Male	Male	227A-MFFO	227A-AFFO	227A-0001	
	⑥	227A-AMMO			③	④	⑦	
Accessories	⑦	227A-0001	Female		①	②	⑤	⑥

UNLESS OTHERWISE SPECIFIED TOLERANCE			
UNIT:	DECIMAL	LINEAR	ANGLES
mm	X.	±0.50	±5°
	X.X	±0.25	±3°
	X.XX	±0.12	±1°

ATTEND
www.attend.com.tw

DRAWN	Fros	2020/06/10	DRAWN NAME: A Size Connector, Application Drawing
CHECKED	Tim	2020/06/10	
APPROVED	Ken	2020/06/10	
SCALE 1/2			PRODUCT NO.
SHEET 1/1			FILE NAME 227A-Series_B_1
SIZE A4			