

THIS DOCUMENT IS THE PROPERTY OF
KEYSTONE ELECTRONICS CORP. AND
SHALL NOT BE REPRODUCED, DISTRIBUTED
OR USED AS A BASIS FOR MANUFACTURE
WITHOUT PRIOR WRITTEN PERMISSION
FROM KEYSTONE ELECTRONICS CORP.

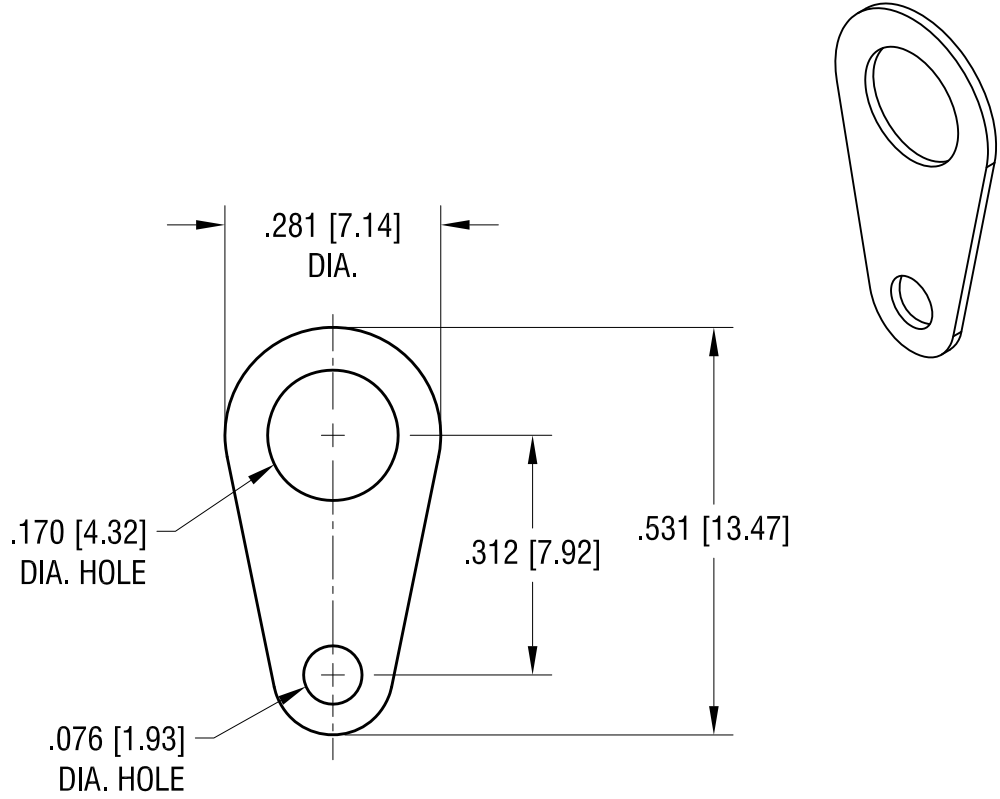

6.25.09	CHANGE AS PER ECN 09-083	C
7.27.04	CHANGE AS PER ECN 04-052	B
10.20.03	CHANGE AS PER ECN 03-076	A
DATE	DESCRIPTION	REV.

KEYSTONE ELECTRONICS CORP.			
www.keyelco.com • ASTORIA, N.Y. 11105-2017 • Tel (718) 956-8900			
PART NAME			
SOLDER TERMINAL LUG			
MATERIAL			
.015 [0.38] TH'K BRASS			
FINISH		DRN BY	DATE
MATTE TIN PLATE		BOONE	3.15.84
		APP'D	SCALE
		LN	4X
TOLERANCES	INCH [MM]	CODE	DWG NO.
DECIMAL	± .005 [± 0.15]	C	7330
ANGULAR	± 1°		
UNLESS OTHERWISE SPECIFIED			