

Data sheet | Item number: 2202-1961

2-conductor carrier terminal block; with push-button; with additional jumper position; for DIN-rail 35 x 15 and 35 x 7.5; 2.5 mm²; Push-in CAGE CLAMP®; 2,50 mm²; gray

www.wago.com/2202-1961

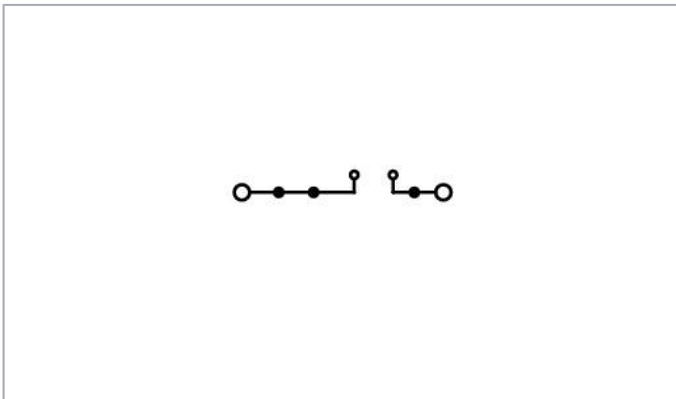
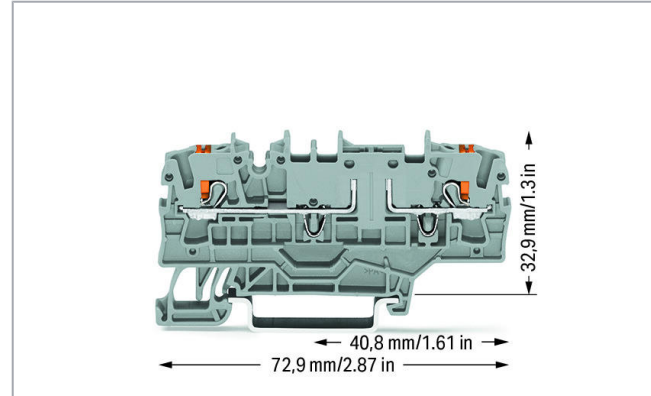
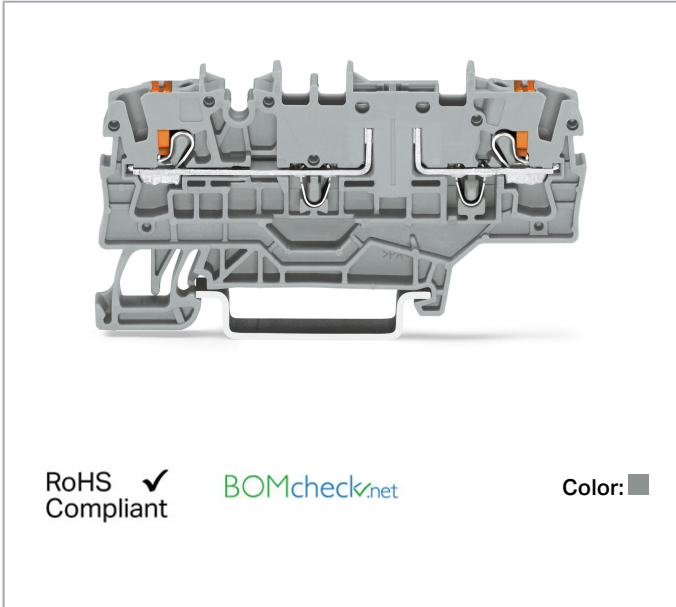

Data

Electrical data

Ratings per IEC/EN

| Ratings per | IEC/EN 60947-7-1 |
|-----------------------------|------------------|
| Nominal voltage (III/3) | 400 V |
| Rated surge voltage (III/3) | 6 kV |
| Rated current | 16 A |

Subject to changes. Please also observe the further product documentation!

WAGO Kontakttechnik GmbH & Co. KG
Hansastr. 27
32423 Minden
Phone: +49571 887-0 | Fax: +49571 887-169
Email: info.de@wago.com | Web: www.wago.com

Do you have any questions about our products?
We are always happy to take your call at 01788 568 008.

Legend (ratings)

(III / 3) ≙ Overvoltage category III / Pollution degree 3

Ratings per UL

| | |
|--------------------------------|---------|
| Approvals per | UL 1059 |
| Rated voltage UL (Use Group B) | 300 V |
| Rated current UL (Use Group B) | 15 A |
| Rated voltage UL (Use Group C) | 300 V |
| Rated current UL (Use Group C) | 15 A |

Ratings per CSA

| | |
|---------------------------------|--------------|
| Approvals per | C22.2 No 158 |
| Rated voltage CSA (Use Group B) | 300 V |
| Rated current CSA (Use Group B) | 15 A |
| Rated voltage CSA (Use Group C) | 300 V |
| Rated current CSA (Use Group C) | 15 A |

Connection data

| | |
|--|---|
| Connection technology | Push-in CAGE CLAMP® |
| Actuation type | Push-in Push-button Operating tool |
| Connectable conductor materials | Copper |
| Nominal cross-section | 2.5 mm ² |
| Solid conductor | 0.25 ... 4 mm ² / 22 ... 12 AWG |
| Solid conductor; push-in termination | 0.75 ... 4 mm ² / 18 ... 12 AWG |
| Fine-stranded conductor | 0.25 ... 4 mm ² / 22 ... 12 AWG |
| Fine-stranded conductor; with insulated ferrule | 1 ... 2.5 mm ² / 18 ... 14 AWG |
| Fine-stranded conductor; with ferrule; push-in termination | 1 ... 2.5 mm ² / 18 ... 14 AWG |
| Note (conductor cross-section) | Depending on the conductor characteristic, a conductor with a smaller cross-section can also be inserted via push-in termination. |
| Strip length | 10 ... 12 mm / 0.39 ... 0.47 inch |
| Total number of connection points | 2 |
| Total number of potentials | 2 |
| Number of levels | 1 |
| Wiring type | Front-entry wiring |
| Number of jumper slots | 3 |

Subject to changes. Please also observe the further product documentation!

Physical data

| | |
|--------|---------------------|
| Width | 5.2 mm / 0.205 inch |
| Height | 72.9 mm / 2.87 inch |

Mechanical data

| | |
|---------------|---------------------|
| Design | horizontal type |
| Mounting type | DIN-35 rail |
| Marking level | Center/side marking |

Material data



| | |
|---------------------|------------------|
| Color | gray |
| Insulation material | Polyamide (PA66) |
| Weight | 7.9 g |

Commercial data

| | |
|-----------------------|---------------|
| Packaging type | BOX |
| Country of origin | DE |
| GTIN | 4055143962391 |
| Customs tariff number | 85369010000 |

Approvals / Certificates

Ex-Approvals

| Logo | Approval | Additional Approval Text | Certificate name |
|--|---------------------------------------|--------------------------|------------------|
|  | AEx Underwriters Laboratories Inc. | UL 60079 | E185892 |
|  | CCCEX CQST/CNEX | CNCA-C23-01 | 2020312313000288 |



UL-Approvals

| Logo | Approval | Additional Approval Text | Certificate name |
|--|--------------------------------------|--------------------------|------------------|
|  | UL Underwriters Laboratories Inc. | UL 1059 | E45172 |

Subject to changes. Please also observe the further product documentation!

Required accessories

End plate

| | | |
|--|--|--|
|  | Item no.: 2002-1991 End and intermediate plate; 1 mm thick; gray | www.wago.com/2002-1991 |
|  | Item no.: 2002-1992 End and intermediate plate; 1 mm thick; orange | www.wago.com/2002-1992 |

Compatible products







Insulation stop

| | | |
|--|---|--|
|  | Item no.: 2002-171 Insulation stop; 0.25 - 0.5 mm ² ; 5 pieces/strip; light gray | www.wago.com/2002-171 |
|  | Item no.: 2002-172 Insulation stop; 0.75 - 1 mm ² ; 5 pieces/strip; dark gray | www.wago.com/2002-172 |















General accessories

| | | |
|--|--|--|
|  | Item no.: 2002-401 Disconnect plug for carrier terminal blocks; for using a receptacle terminal block as a disconnect terminal block; orange | www.wago.com/2002-401 |
|--|--|--|

Marking accessories

| | | |
|--|--|--|
|  | Item no.: 2002-121 Adaptor; gray | www.wago.com/2002-121 |
|  | Item no.: 2002-161 Adaptor; gray | www.wago.com/2002-161 |
|  | Item no.: 2009-110 Marking strips; for Smart Printer; on reel; not stretchable; plain; snap-on type; white | www.wago.com/2009-110 |
|  | Item no.: 2009-115 WMB-Inline; for Smart Printer; 1500 pieces on roll; stretchable 5 - 5.2 mm; plain; snap-on type; white | www.wago.com/2009-115 |
|  | Item no.: 2009-115/000-002 WMB-Inline; for Smart Printer; 1500 pieces on roll; stretchable 5 - 5.2 mm; plain; snap-on type; yellow | www.wago.com/2009-115/000-002 |
|  | Item no.: 2009-115/000-005 WMB-Inline; for Smart Printer; 1500 pieces on roll; stretchable 5 - 5.2 mm; plain; snap-on type; red | www.wago.com/2009-115/000-005 |
|  | Item no.: 2009-115/000-006 WMB-Inline; for Smart Printer; 1500 pieces on roll; stretchable 5 - 5.2 mm; plain; snap-on type; blue | www.wago.com/2009-115/000-006 |

Subject to changes. Please also observe the further product documentation!

| | | |
|--|---|--|
|  | Item no.: 2009-115/000-007 WMB-Inline; for Smart Printer; 1500 pieces on roll; stretchable 5 - 5.2 mm; plain; snap-on type; gray | www.wago.com/2009-115/000-007 |
|  | Item no.: 2009-115/000-012 WMB-Inline; for Smart Printer; 1500 pieces on roll; stretchable 5 - 5.2 mm; plain; snap-on type; orange | www.wago.com/2009-115/000-012 |
|  | Item no.: 2009-115/000-017 WMB-Inline; for Smart Printer; 1500 pieces on roll; stretchable 5 - 5.2 mm; plain; snap-on type; light green | www.wago.com/2009-115/000-017 |
|  | Item no.: 2009-115/000-023 WMB-Inline; for Smart Printer; 1500 pieces on roll; stretchable 5 - 5.2 mm; plain; snap-on type; green | www.wago.com/2009-115/000-023 |
|  | Item no.: 2009-115/000-024 WMB-Inline; for Smart Printer; 1500 pieces on roll; stretchable 5 - 5.2 mm; plain; snap-on type; violet | www.wago.com/2009-115/000-024 |
|  | Item no.: 2009-145 Mini-WSB Inline; for Smart Printer; 1700 pieces on roll; stretchable 5 - 5.2 mm; plain; snap-on type; white | www.wago.com/2009-145 |
|  | Item no.: 2009-145/000-002 Mini-WSB Inline; for Smart Printer; 1700 pieces on roll; stretchable 5 - 5.2 mm; plain; snap-on type; yellow | www.wago.com/2009-145/000-002 |
|  | Item no.: 2009-145/000-005 Mini-WSB Inline; for Smart Printer; 1700 pieces on roll; stretchable 5 - 5.2 mm; plain; snap-on type; red | www.wago.com/2009-145/000-005 |
|  | Item no.: 2009-145/000-006 Mini-WSB Inline; for Smart Printer; 1700 pieces on roll; stretchable 5 - 5.2 mm; plain; snap-on type; blue | www.wago.com/2009-145/000-006 |
|  | Item no.: 2009-145/000-007 Mini-WSB Inline; for Smart Printer; 1700 pieces on roll; stretchable 5 - 5.2 mm; plain; snap-on type; gray | www.wago.com/2009-145/000-007 |
|  | Item no.: 2009-145/000-012 Mini-WSB Inline; for Smart Printer; 1700 pieces on roll; stretchable 5 - 5.2 mm; plain; snap-on type; orange | www.wago.com/2009-145/000-012 |
|  | Item no.: 2009-145/000-023 Mini-WSB Inline; for Smart Printer; 1700 pieces on roll; stretchable 5 - 5.2 mm; plain; snap-on type; green | www.wago.com/2009-145/000-023 |
|  | Item no.: 2009-145/000-024 Mini-WSB Inline; for Smart Printer; 1700 pieces on roll; stretchable 5 - 5.2 mm; plain; snap-on type; violet | www.wago.com/2009-145/000-024 |
|  | Item no.: 248-501 Miniature WSB Quick marking system; plain; Marker width 5 mm; 10 strips with 10 markers per card | www.wago.com/248-501 |

Subject to changes. Please also observe the further product documentation!



Item no.: 248-501/000-002

Mini-WSB marking card; as card; not stretchable; plain; snap-on type; yellow

www.wago.com/248-501/000-002



Item no.: 248-501/000-005

Mini-WSB marking card; as card; not stretchable; plain; snap-on type; red

www.wago.com/248-501/000-005



Item no.: 248-501/000-006

Mini-WSB marking card; as card; not stretchable; plain; snap-on type; blue

www.wago.com/248-501/000-006



Item no.: 248-501/000-007

Mini-WSB marking card; as card; not stretchable; plain; snap-on type; gray

www.wago.com/248-501/000-007



Item no.: 248-501/000-012

Mini-WSB marking card; as card; not stretchable; plain; snap-on type; orange

www.wago.com/248-501/000-012



Item no.: 248-501/000-017

Mini-WSB marking card; as card; not stretchable; plain; snap-on type; light green

www.wago.com/248-501/000-017



Item no.: 248-501/000-023

Mini-WSB marking card; as card; not stretchable; plain; snap-on type; green

www.wago.com/248-501/000-023



Item no.: 248-501/000-024

Mini-WSB marking card; as card; not stretchable; plain; snap-on type; violet

www.wago.com/248-501/000-024



Item no.: 793-501

WMB marking card; as card; not stretchable; plain; snap-on type; white

www.wago.com/793-501



Item no.: 793-501/000-002

WMB marking card; as card; not stretchable; plain; snap-on type; yellow

www.wago.com/793-501/000-002



Item no.: 793-501/000-005

WMB marking card; as card; not stretchable; plain; snap-on type; red

www.wago.com/793-501/000-005



Item no.: 793-501/000-006

WMB marking card; as card; not stretchable; plain; snap-on type; blue

www.wago.com/793-501/000-006



Item no.: 793-501/000-007

WMB marking card; as card; not stretchable; plain; snap-on type; gray

www.wago.com/793-501/000-007

Subject to changes. Please also observe the further product documentation!

WAGO Kontakttechnik GmbH & Co. KG

Hansastr. 27

32423 Minden

Phone: +49571 887-0 | Fax: +49571 887-169

Email: info.de@wago.com | Web: www.wago.com

Do you have any questions about our products?

We are always happy to take your call at 01788 568 008.



Item no.: 793-501/000-012
WMB marking card; as card; not stretchable; plain; snap-on type; orange

www.wago.com/793-501/000-012



Item no.: 793-501/000-017
WMB marking card; as card; not stretchable; plain; snap-on type; light green

www.wago.com/793-501/000-017



Item no.: 793-501/000-023
WMB marking card; as card; not stretchable; plain; snap-on type; green

www.wago.com/793-501/000-023



Item no.: 793-501/000-024
WMB marking card; as card; not stretchable; plain; snap-on type; violet

www.wago.com/793-501/000-024



Item no.: 793-5501
WMB marking card; as card; for terminal block width 5 - 17.5 mm; stretchable 5 - 5.2 mm; plain; snap-on type; white

www.wago.com/793-5501



Item no.: 793-5501/000-002
WMB marking card; as card; for terminal block width 5 - 17.5 mm; stretchable 5 - 5.2 mm; plain; snap-on type; yellow

www.wago.com/793-5501/000-002



Item no.: 793-5501/000-005
WMB marking card; as card; for terminal block width 5 - 17.5 mm; stretchable 5 - 5.2 mm; plain; snap-on type; red

www.wago.com/793-5501/000-005



Item no.: 793-5501/000-006
WMB marking card; as card; for terminal block width 5 - 17.5 mm; stretchable 5 - 5.2 mm; plain; snap-on type; blue

www.wago.com/793-5501/000-006



Item no.: 793-5501/000-007
WMB marking card; as card; for terminal block width 5 - 17.5 mm; stretchable 5 - 5.2 mm; plain; snap-on type; gray

www.wago.com/793-5501/000-007



Item no.: 793-5501/000-012
WMB marking card; as card; for terminal block width 5 - 17.5 mm; stretchable 5 - 5.2 mm; plain; snap-on type; orange

www.wago.com/793-5501/000-012



Item no.: 793-5501/000-014
WMB marking card; as card; for terminal block width 5 - 17.5 mm; stretchable 5 - 5.2 mm; plain; snap-on type; brown

www.wago.com/793-5501/000-014



Item no.: 793-5501/000-017
WMB marking card; as card; for terminal block width 5 - 17.5 mm; stretchable 5 - 5.2 mm; plain; snap-on type; green

www.wago.com/793-5501/000-017



Item no.: 793-5501/000-023
WMB marking card; as card; for terminal block width 5 - 17.5 mm; stretchable 5 - 5.2 mm; plain; snap-on type; light green

www.wago.com/793-5501/000-023

Item no.: 793-5501/000-024

Subject to changes. Please also observe the further product documentation!



WMB marking card; as card; for terminal block width 5 - 17.5 mm; stretchable 5 - 5.2 mm; plain; snap-on type; violet

www.wago.com/793-5501/000-024

Push-In type wire jumper



Item no.: 2009-412
Push-in type wire jumper; insulated; 60 mm long; black

www.wago.com/2009-412



Item no.: 2009-414
Push-in type wire jumper; 1.5 mm²; insulated; 110 mm long; black

www.wago.com/2009-414



Item no.: 2009-414/000-005
Push-in type wire jumper; 1.5 mm²; insulated; 110 mm long; black

www.wago.com/2009-414/000-005



Item no.: 2009-414/000-006
Push-in type wire jumper; insulated; 110 mm long; black

www.wago.com/2009-414/000-006



Item no.: 2009-416
Push-in type wire jumper; 1.5 mm²; insulated; 250 mm long; black

www.wago.com/2009-416

Jumper



Item no.: 2002-400
Continuous jumper; 2-way; insulated; light gray

www.wago.com/2002-400



Item no.: 2002-402
Jumper; 2-way; insulated; light gray

www.wago.com/2002-402



Item no.: 2002-402/000-005
Jumper; 2-way; insulated; red

www.wago.com/2002-402/000-005



Item no.: 2002-402/000-006
Jumper; 2-way; insulated; blue

www.wago.com/2002-402/000-006



Item no.: 2002-403
Jumper; 3-way; insulated; light gray

www.wago.com/2002-403



Item no.: 2002-403/000-005
Jumper; 3-way; insulated; red

www.wago.com/2002-403/000-005



Item no.: 2002-403/000-006
Jumper; 3-way; insulated; blue















www.wago.com/2002-403/000-006

















Item no.: 2002-404
Jumper; 4-way; insulated; light gray

www.wago.com/2002-404















Subject to changes. Please also observe the further product documentation!

| | | |
|--|--|--|
|  | Item no.: 2002-404/000-005 Jumper; 4-way; insulated; red | www.wago.com/2002-404/000-005 |
|  | Item no.: 2002-404/000-006 Jumper; 4-way; insulated; blue | www.wago.com/2002-404/000-006 |
|  | Item no.: 2002-405 Jumper; 5-way; insulated; light gray | www.wago.com/2002-405 |
|  | Item no.: 2002-405/000-005 Jumper; 5-way; insulated; red | www.wago.com/2002-405/000-005 |
|  | Item no.: 2002-405/000-006 Jumper; 5-way; insulated; blue | www.wago.com/2002-405/000-006 |
|  | Item no.: 2002-405/011-000 Star point jumper; 3-way; insulated; light gray | www.wago.com/2002-405/011-000 |
|  | Item no.: 2002-406 Jumper; 6-way; insulated; light gray | www.wago.com/2002-406 |
|  | Item no.: 2002-406/000-005 Jumper; 6-way; insulated; red | www.wago.com/2002-406/000-005 |
|  | Item no.: 2002-406/000-006 Jumper; 6-way; insulated; blue | www.wago.com/2002-406/000-006 |
|  | Item no.: 2002-406/020-000 Delta jumper; insulated; light gray | www.wago.com/2002-406/020-000 |
|  | Item no.: 2002-407 Jumper; 7-way; insulated; light gray | www.wago.com/2002-407 |
|  | Item no.: 2002-407/000-005 Jumper; 7-way; insulated; red | www.wago.com/2002-407/000-005 |
|  | Item no.: 2002-407/000-006 Jumper; 7-way; insulated; blue | www.wago.com/2002-407/000-006 |
|  | Item no.: 2002-408 Jumper; 8-way; insulated; light gray | www.wago.com/2002-408 |















Subject to changes. Please also observe the further product documentation!

| | | |
|--|--|--|
|  | Item no.: 2002-408/000-005 Jumper; 8-way; insulated; red | www.wago.com/2002-408/000-005 |
|  | Item no.: 2002-408/000-006 Jumper; 8-way; insulated; blue | www.wago.com/2002-408/000-006 |
|  | Item no.: 2002-409 Jumper; 9-way; insulated; light gray | www.wago.com/2002-409 |
|  | Item no.: 2002-409/000-005 Jumper; 9-way; insulated; red | www.wago.com/2002-409/000-005 |
|  | Item no.: 2002-409/000-006 Jumper; 9-way; insulated; blue | www.wago.com/2002-409/000-006 |
|  | Item no.: 2002-410 Jumper; 10-way; insulated; light gray | www.wago.com/2002-410 |
|  | Item no.: 2002-410/000-005 Jumper; 10-way; insulated; red | www.wago.com/2002-410/000-005 |
|  | Item no.: 2002-410/000-006 Jumper; 10-way; insulated; blue | www.wago.com/2002-410/000-006 |
|  | Item no.: 2002-423 Continuous jumper; from 1 to 3; insulated; light gray | www.wago.com/2002-423 |
|  | Item no.: 2002-423/000-005 Continuous jumper; from 1 to 3; insulated; red | www.wago.com/2002-423/000-005 |
|  | Item no.: 2002-423/000-006 Continuous jumper; from 1 to 3; insulated; blue | www.wago.com/2002-423/000-006 |
|  | Item no.: 2002-433 Jumper; from 1 to 3; insulated; light gray | www.wago.com/2002-433 |
|  | Item no.: 2002-434 Jumper; from 1 to 4; insulated; light gray | www.wago.com/2002-434 |
|  | Item no.: 2002-435 Jumper; from 1 to 5; insulated; light gray | www.wago.com/2002-435 |
|  | Item no.: 2002-436 Jumper; from 1 to 6; insulated; light gray | www.wago.com/2002-436 |

Subject to changes. Please also observe the further product documentation!

| | | |
|--|--|--|
|  | Item no.: 2002-437 Jumper; from 1 to 7; insulated; light gray | www.wago.com/2002-437 |
|  | Item no.: 2002-438 Jumper; from 1 to 8; insulated; light gray | www.wago.com/2002-438 |
|  | Item no.: 2002-439 Jumper; from 1 to 9; insulated; light gray | www.wago.com/2002-439 |
|  | Item no.: 2002-440 Jumper; from 1 to 10; insulated; light gray | www.wago.com/2002-440 |
|  | Item no.: 2002-472 Staggered jumper; 2-way; insulated; light gray | www.wago.com/2002-472 |
|  | Item no.: 2002-473 Staggered jumper; 3-way; insulated; light gray | www.wago.com/2002-473 |
| | Item no.: 2002-473/011-000 Staggered jumper; 2-way; from 1 to 3; insulated; light gray | www.wago.com/2002-473/011-000 |
|  | Item no.: 2002-474 Staggered jumper; 4-way; insulated; light gray | www.wago.com/2002-474 |
|  | Item no.: 2002-475 Staggered jumper; 5-way; insulated; light gray | www.wago.com/2002-475 |
| | Item no.: 2002-475/011-000 Staggered jumper; 3-way; insulated; light gray | www.wago.com/2002-475/011-000 |
|  | Item no.: 2002-476 Staggered jumper; 6-way; insulated; light gray | www.wago.com/2002-476 |
|  | Item no.: 2002-477 Staggered jumper; 7-way; insulated; light gray | www.wago.com/2002-477 |
|  | Item no.: 2002-477/011-000 Staggered jumper; insulated; light gray | www.wago.com/2002-477/011-000 |
|  | Item no.: 2002-478 Staggered jumper; 8-way; insulated; light gray | www.wago.com/2002-478 |
|  | Item no.: 2002-479 Staggered jumper; 9-way; insulated; light gray | www.wago.com/2002-479 |
| | Item no.: 2002-479/011-000 Staggered jumper; insulated; light gray | www.wago.com/2002-479/011-000 |
|  | Item no.: 2002-480 Staggered jumper; 10-way; insulated; light gray | www.wago.com/2002-480 |

Subject to changes. Please also observe the further product documentation!

| | | |
|--|--|--|
|  | Item no.: 2002-481 Staggered jumper; 11-way; insulated; light gray | www.wago.com/2002-481 |
| | Item no.: 2002-481/011-000 Staggered jumper; insulated; light gray | www.wago.com/2002-481/011-000 |
|  | Item no.: 2002-482 Staggered jumper; 12-way; insulated; light gray | www.wago.com/2002-482 |
|  | Item no.: 210-103 Wire commoning chain; insulated; black | www.wago.com/210-103 |
|  | Item no.: 210-123 Wire commoning chain; insulated; blue | www.wago.com/210-123 |
| check | | |
|  | Item no.: 210-136 Test plug; 2 mm Ø; with 500 mm cable; red | www.wago.com/210-136 |
| tools | | |
|  | Item no.: 210-658 Operating tool; Blade: 3.5 x 0.5 mm; with a partially insulated shaft; angled; short; multicoloured | www.wago.com/210-658 |
|  | Item no.: 210-720 Operating tool; Blade: 3.5 x 0.5 mm; with a partially insulated shaft; multicoloured | www.wago.com/210-720 |
| ferrule | | |
|  | Item no.: 216-241 Ferrule; Sleeve for 0.5 mm ² / 20 AWG; insulated; electro-tin plated; electrolytic copper; gastight crimped; acc. to DIN 46228, Part 4/09.90; white | www.wago.com/216-241 |
|  | Item no.: 216-242 Ferrule; Sleeve for 0.75 mm ² / 18 AWG; insulated; electro-tin plated; electrolytic copper; gastight crimped; acc. to DIN 46228, Part 4/09.90; gray | www.wago.com/216-242 |
|  | Item no.: 216-243 Ferrule; Sleeve for 1 mm ² / AWG 18; insulated; electro-tin plated; electrolytic copper; gastight crimped; acc. to DIN 46228, Part 4/09.90; red | www.wago.com/216-243 |
|  | Item no.: 216-244 Ferrule; Sleeve for 1.5 mm ² / AWG 16; insulated; electro-tin plated; electrolytic copper; gastight crimped; acc. to DIN 46228, Part 4/09.90; black | www.wago.com/216-244 |
|  | Item no.: 216-246 Ferrule; Sleeve for 2.5 mm ² / AWG 14; insulated; electro-tin plated; electrolytic copper; gastight crimped; acc. to DIN 46228, Part 4/09.90; blue | www.wago.com/216-246 |
|  | Item no.: 216-262 Ferrule; Sleeve for 0.75 mm ² / 18 AWG; insulated; electro-tin plated; electrolytic copper; gastight crimped; acc. to DIN 46228, Part 4/09.90; gray | www.wago.com/216-262 |
|  | Item no.: 216-263 Ferrule; Sleeve for 1 mm ² / AWG 18; insulated; electro-tin plated; electrolytic copper; gastight crimped; acc. to DIN 46228, Part 4/09.90; red | www.wago.com/216-263 |
| | Item no.: 216-264 | |

Subject to changes. Please also observe the further product documentation!

| | | |
|--|---|--|
|  | Ferrule; Sleeve for 1.5 mm ² / AWG 16; insulated; electro-tin plated; electrolytic copper; gastight crimped; acc. to DIN 46228, Part 4/09.90; black | www.wago.com/216-264 |
|  | Item no.: 216-266 Ferrule; Sleeve for 2.5 mm ² / AWG 14; insulated; electro-tin plated; electrolytic copper; gastight crimped; acc. to DIN 46228, Part 4/09.90; blue | www.wago.com/216-266 |
| plug | | |
|  | Item no.: 2002-800 Empty component plug housing; 5.2 mm wide; 2-pole; Type 1; gray | www.wago.com/2002-800 |
|  | Item no.: 2002-800/1000-410 Component plug; for carrier terminal blocks; 2-pole; with diode 1N4007; anode, left side; 5.2 mm wide; Operating temperature 85°C max.; gray | www.wago.com/2002-800/1000-410 |
|  | Item no.: 2002-800/1000-411 Component plug; for carrier terminal blocks; 2-pole; with diode 1N4007; 5.2 mm wide; Operating temperature 85°C max.; gray | www.wago.com/2002-800/1000-411 |
|  | Item no.: 2002-800/1000-541 Component plug; for carrier terminal blocks; 1-pole; LED (red); 5.2 mm wide; Operating temperature 85°C max.; gray | www.wago.com/2002-800/1000-541 |
|  | Item no.: 2002-800/1000-542 Component plug; for carrier terminal blocks; 1-pole; LED (red); 5.2 mm wide; Operating temperature 85°C max.; gray | www.wago.com/2002-800/1000-542 |
|  | Item no.: 2002-800/1000-836 Component plug; for carrier terminal blocks; 1-pole; LED (red); 5.2 mm wide; Operating temperature 85°C max.; gray | www.wago.com/2002-800/1000-836 |
|  | Item no.: 2002-810 Empty component plug housing; 10.4 mm wide; 2-pole; Type 2; gray | www.wago.com/2002-810 |
|  | Item no.: 2002-820 Empty component plug housing; 10.4 mm wide; 4-pole; Type 3; gray | www.wago.com/2002-820 |
|  | Item no.: 2003-911 Double fuse plug; for 5 x 20 mm miniature metric fuse; without blown fuse indication; 10.4 mm wide; gray | www.wago.com/2003-911 |
|  | Item no.: 2003-911/1000-923 Double fuse plug; for 5 x 20 mm miniature metric fuse; with indicator lamp; 230 V; 10.4 mm wide; gray | www.wago.com/2003-911/1000-923 |
|  | Item no.: 2004-911 Fuse plug; with pull-tab; for miniature metric fuses 5 x 20 mm and 5 x 25 mm; without blown fuse indication; 6.1 mm wide; gray | www.wago.com/2004-911 |
|  | Item no.: 2004-911/1000-541 Fuse plug; with pull-tab; for 5 x 20 mm miniature metric fuse; with indicator lamp; 12 - 30 V; 6.1 mm wide; gray | www.wago.com/2004-911/1000-541 |
| | Item no.: 2004-911/1000-542 Fuse plug; with pull-tab; for 5 x 20 mm miniature metric fuse; with indicator lamp; 30 - 65 V; 6.1 mm | |

Subject to changes. Please also observe the further product documentation!



wide; gray

www.wago.com/2004-911/1000-542



Item no.: 2004-911/1000-836

Fuse plug; with pull-tab; for 5 x 20 mm miniature metric fuse; with indicator lamp; 230 V; 6.1 mm wide; gray

www.wago.com/2004-911/1000-836



Item no.: 2004-911/1000-867

Fuse plug; with pull-tab; for 5 x 20 mm miniature metric fuse; with indicator lamp; 120 V; 6.1 mm wide; gray

www.wago.com/2004-911/1000-867

Carrier rail



Item no.: 210-112

Steel carrier rail; 35 x 7.5 mm; 1 mm thick; 2 m long; slotted; according to EN 60715; "Hole width 25 mm; silver-colored www.wago.com/210-112



Item no.: 210-113

Steel carrier rail; 35 x 7.5 mm; 1 mm thick; 2 m long; unslotted; according to EN 60715; silver-colored

www.wago.com/210-113



Item no.: 210-114

Steel carrier rail; 35 x 15 mm; 1.5 mm thick; 2 m long; unslotted; similar to EN 60715; silver-colored

www.wago.com/210-114



Item no.: 210-115

Steel carrier rail; 35 x 7.5 mm; 1 mm thick; 2 m long; slotted; according to EN 60715; "Hole width 18 mm; silver-colored www.wago.com/210-115



Item no.: 210-118

Steel carrier rail; 35 x 15 mm; 2.3 mm thick; 2 m long; unslotted; according to EN 60715; silver-colored

www.wago.com/210-118



Item no.: 210-196

Aluminum carrier rail; 35 x 8.2 mm; 1.6 mm thick; 2 m long; unslotted; similar to EN 60715; silver-colored

www.wago.com/210-196



Item no.: 210-197

Steel carrier rail; 35 x 15 mm; 1.5 mm thick; 2 m long; slotted; similar to EN 60715; silver-colored

www.wago.com/210-197



Item no.: 210-198

Copper carrier rail; 35 x 15 mm; 2.3 mm thick; 2 m long; unslotted; according to EN 60715; copper-colored

www.wago.com/210-198



Item no.: 210-504

Steel carrier rail; 35 x 7.5 mm; 1 mm thick; 2 m long; slotted; galvanized; according to EN 60715; silver-colored www.wago.com/210-504



Item no.: 210-505

Steel carrier rail; 35 x 7.5 mm; 1 mm thick; 2 m long; unslotted; galvanized; according to EN 60715; silver-colored

www.wago.com/210-505



Item no.: 210-506

Steel carrier rail; 35 x 15 mm; 1.5 mm thick; 2 m long; unslotted; galvanized; similar to EN 60715; silver-colored www.wago.com/210-506



Item no.: 210-508

Steel carrier rail; 35 x 15 mm; 1.5 mm thick; 2 m long; slotted; galvanized; similar to EN 60715; silver-colored www.wago.com/210-508

Subject to changes. Please also observe the further product documentation!

WAGO Kontakttechnik GmbH & Co. KG

Hansastr. 27

32423 Minden

Phone: +49571 887-0 | Fax: +49571 887-169

Email: info.de@wago.com | Web: www.wago.com

Do you have any questions about our products?

We are always happy to take your call at 01788 568 008.

Downloads

Documentation

Additional Information

Technical explanations

3. 4. 2019

pdf
2.2 MB

Download

Installation Notes

Conductor termination

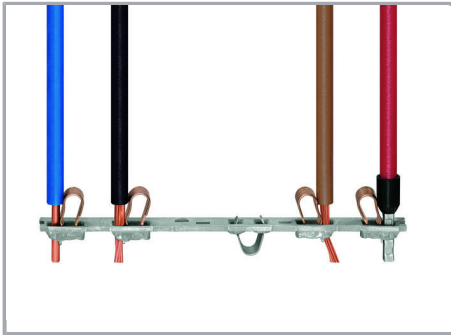

All conductor types at a glance

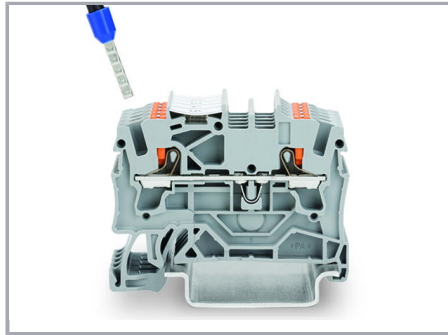

Push-in termination of solid and ferruled conductors

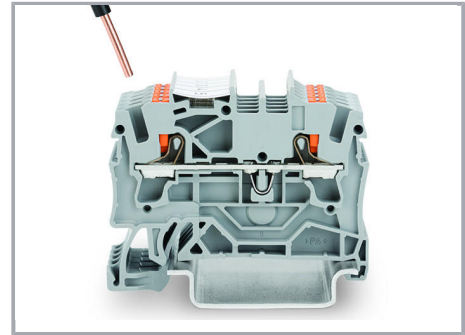

Push-in termination of solid and ferruled conductors



Insert fine-stranded conductors via operating tool.



Removing all conductors via operating tool.

Commoning

Subject to changes. Please also observe the further product documentation!

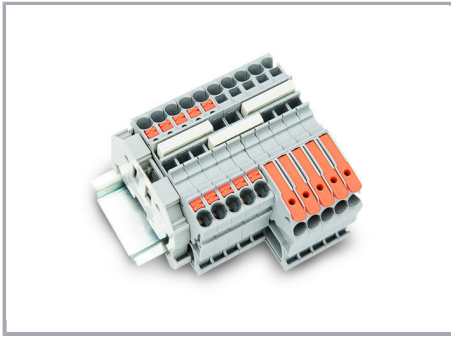

Insert a push-in type jumper bar and push down until it hits the backstop.

Marking

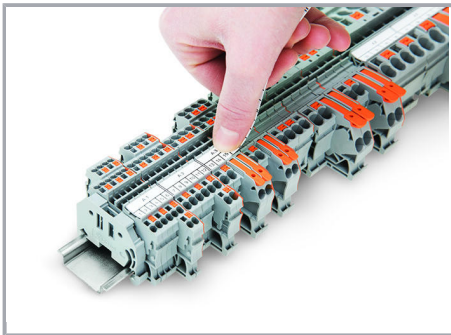

Snapping a marking strip into a marker slot.

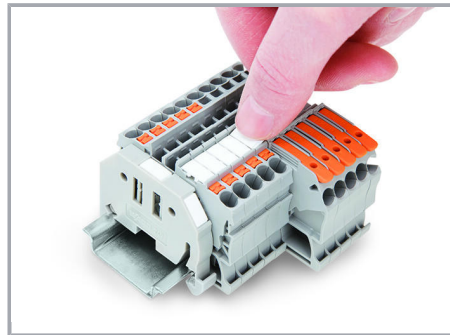

Snapping a marking strip into the marker slot.

Product family

TOPJOB® S

TOPJOB® S: In various industrial applications and modern building installations, WAGO's wide and versatile range of rail-mount terminal blocks provides more than just reliable electrical connections.

[Show all products from the family](#)

Subject to changes. Please also observe the further product documentation!