

THIS DOCUMENT IS THE PROPERTY OF
KEYSTONE ELECTRONICS CORP. AND
SHALL NOT BE REPRODUCED, DISTRIBUTED
OR USED AS A BASIS FOR MANUFACTURE
WITHOUT PRIOR WRITTEN PERMISSION
FROM KEYSTONE ELECTRONICS CORP.

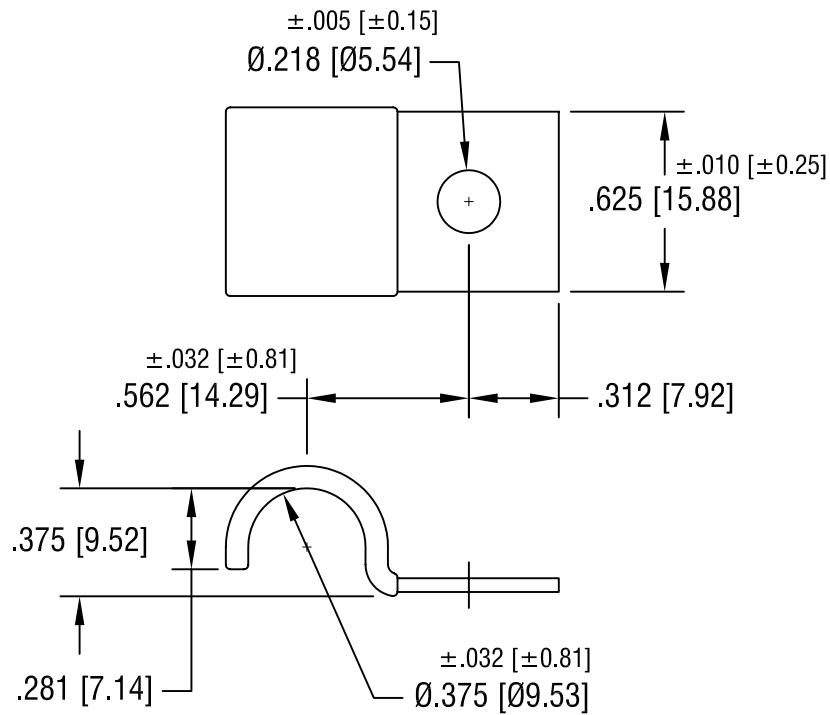

NOTES:

1. FINISH:
PRE-PLATED HOT DIPPED GALVANIZED

KEYSTONE ELECTRONICS CORP.			
ASTORIA, N.Y. 11105-2017			
PART NAME		INSULATED STEEL HALF CLAMP	
MATERIAL		.048 [1.22] TH'K STEEL, BLACK VINYL	
FINISH		DRN BY	DATE
AS NOTED		BOONE	7.20.05
		APP'D	SCALE
			1.5X
TOLERANCES	INCH [MM]	CODE	DWG NO.
DECIMAL	± .015 [± 0.38]	C/M	8163
ANGULAR	± 1°		
UNLESS OTHERWISE SPECIFIED			

DATE	DESCRIPTION	REV.