

Data sheet | Item number: 2201-1201

TOPJOB®S feedthrough terminal block with Push-buttons; rail mount; 2-conductor; 4.2 mm wide; gray

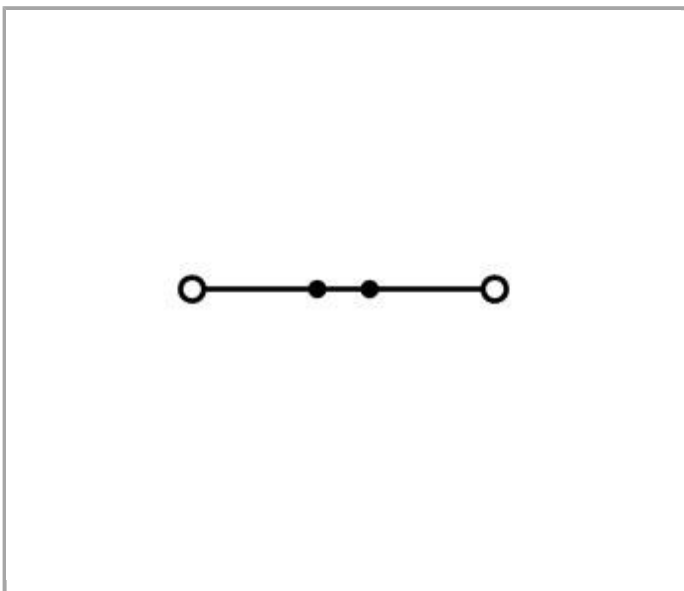

www.wago.com/2201-1201

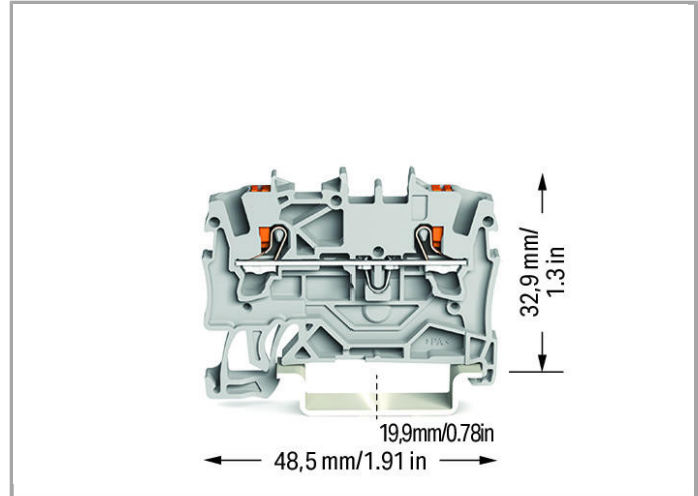
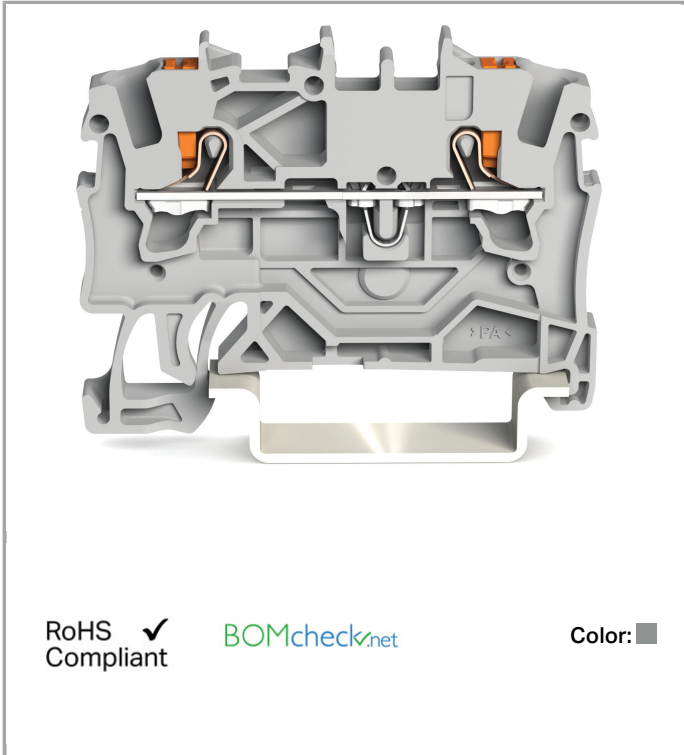

Data
Electrical data



Ratings per IEC/EN 60664-1

Rated voltage (III / 3)	800 V
Rated impulse voltage (III / 3)	8 kV
Rated current	18 A
Rated current (2)	24 A
Legend (ratings)	(III / 3) \triangleq Overvoltage category III / Pollution degree 3

Approvals per UL 1059

Rated voltage UL (Use Group B)	600 V
Rated current UL (Use Group B)	15 A
Rated voltage UL (Use Group C)	600 V
Rated current UL (Use Group C)	15 A

Connection data

Connection technology	Push-in CAGE CLAMP [®]
Actuation type	Push-in Push-button Operating tool
Connectable conductor materials	Copper
Nominal cross section	1.5 mm ²
Solid conductor	0.25 ... 2.5 mm ² / 22 ... 14 AWG
Solid conductor, push-in termination	0.75 ... 2.5 mm ² / 18 ... 14 AWG
Fine-stranded conductor	0.25 ... 2.5 mm ² / 22 ... 14 AWG
Fine-stranded conductor with ferrule, push-in termination, from	0.75 mm ² / 18 AWG
Strip length	9 ... 11 mm / 0.35 ... 0.43 Inch
Number of levels	1
Total number of connection points	2
Total number of potentials	1
Type of wiring	Front-entry wiring

Geometrical Data

Width	4.2 mm / 0.165 inch
Height from upper-edge of DIN-35 rail	32.9 mm / 1.295 inch
Depth	48.5 mm / 1.909 inch

Mechanical data

Design	horizontal
Type of mounting	DIN-35 rail
Marking level	Center/side marking

Material Data

Color	gray
Insulating material	Polyamide 66 (PA 66)
Weight	4.145 g

Commercial data



Packaging type	BOX
Country of origin	DE
GTIN	4055143695152

Approvals / Certificates

Ex-Approvals

Logo	Approval	Certificate name
	AEx UL International Germany GmbH c/o Physikalisch Technische Bundesanstalt	E185892 sec. 25
	ATEX Physikalisch Technische Bundesanstalt	PTB 18 ATEX 1004 U (II 2 G Ex eb IIC Gb bzw. I M 2 Ex eb I Mb)
	IECEX Physikalisch Technische Bundesanstalt	IECEX PTB 18.0011U (Ex eb IIC Gb and Ex eb I Mb)

Country specific Approvals

Logo	Approval	Certificate name
	CCA DEKRA Certification B.V.	NTR NL 7664
	CSA DEKRA Certification B.V.	70173738
	KEMA/KEUR DEKRA Certification B.V.	71-102875

UL-Approvals

Logo	Approval	Certificate name
	cURus Underwriters Laboratories Inc.	4788308064



Compatible products

Insulation stop



Item no.: 2001-171

TOPJOB®S insulation stop; for 2001 series terminal blocks; 0.25 - 0.5 mm²; 5/strip; light gray

www.wago.com/2001-171

ferrule



Item no.: 216-241

Ferrule; Sleeve for 0.5 mm² / AWG 22; insulated; electro-tin plated; electrolytic copper; gastight crimped; acc. to DIN 46228, Part 4/09.90

www.wago.com/216-241



Item no.: 216-242

Ferrule; Sleeve for 0.75 mm² / AWG 20; insulated; electro-tin plated; electrolytic copper; gastight crimped; acc. to DIN 46228, Part 4/09.90

www.wago.com/216-242



Item no.: 216-243

Ferrule; Sleeve for 1 mm² / AWG 18; insulated; electro-tin plated; electrolytic copper; gastight crimped; acc. to DIN 46228, Part 4/09.90

www.wago.com/216-243



Item no.: 216-244

Ferrule; Sleeve for 1.5 mm² / AWG 16; insulated; electro-tin plated; electrolytic copper; gastight crimped; acc. to DIN 46228, Part 4/09.90

www.wago.com/216-244

plug



Item no.: 2002-880

TOPJOB®S empty component plug housing; for 2001-2006 series feedthrough terminal blocks; 2-pole; 10.4 mm wide; gray

www.wago.com/2002-880

Carrier rail



Item no.: 210-112

Steel carrier rail; 35 x 7.5 mm; 1 mm thick; 2 m long; slotted; according to EN 60715; "Hole width 25 mm

www.wago.com/210-112



Item no.: 210-113

Steel carrier rail; 35 x 7.5 mm; 1 mm thick; 2 m long; unslotted; according to EN 60715

www.wago.com/210-113



Item no.: 210-114

Steel carrier rail; 35 x 15 mm; 1.5 mm thick; 2 m long; unslotted; similar to EN 60715

www.wago.com/210-114



Item no.: 210-115

Steel carrier rail; 35 x 7.5 mm; 1 mm thick; 2 m long; slotted; according to EN 60715; "Hole width 18 mm

www.wago.com/210-115



Item no.: 210-118

Steel carrier rail; 35 x 15 mm; 2.3 mm thick; 2 m long; unslotted; according to EN 60715

www.wago.com/210-118



Item no.: 210-196

Aluminum carrier rail; 35 x 8.2 mm; 1.6 mm thick; 2 m long; unslotted; similar to EN 60715

www.wago.com/210-196



Item no.: 210-197

Steel carrier rail; 35 x 15 mm; 1.5 mm thick; 2 m long; slotted; similar to EN 60715

www.wago.com/210-197

**Item no.: 210-198**

Copper carrier rail; 35 x 15 mm; 2.3 mm thick; 2 m long; unslotted; according to EN 60715

www.wago.com/210-198**check****Item no.: 2001-511**

TOPJOB®S modular connector; for 2001 series; for jumper contact slot; 1-pole; gray

www.wago.com/2001-511**Item no.: 2001-549**

TOPJOB®S spacer module; for 2001-511; 4.2 mm wide; gray

www.wago.com/2001-549**Item no.: 2001-552**

TOPJOB®S connector strip; for 2001 series; for jumper contact slot; 2-pole; gray

www.wago.com/2001-552**Item no.: 2001-553**

TOPJOB®S connector strip; for 2001 series; for jumper contact slot; 3-pole; gray

www.wago.com/2001-553**Item no.: 2001-554**

TOPJOB®S connector strip; for 2001 series; for jumper contact slot; 4-pole; gray

www.wago.com/2001-554**Item no.: 2001-555**

TOPJOB®S connector strip; for 2001 series; for jumper contact slot; 5-pole; gray

www.wago.com/2001-555**Item no.: 2001-556**

TOPJOB®S connector strip; for 2001 series; for jumper contact slot; 6-pole; gray

www.wago.com/2001-556**Item no.: 2001-557**

TOPJOB®S connector strip; for 2001 series; for jumper contact slot; 7-pole; gray

www.wago.com/2001-557**Item no.: 2001-558**

TOPJOB®S connector strip; for 2001 series; for jumper contact slot; 8-pole; gray

www.wago.com/2001-558**Item no.: 2001-559**

TOPJOB®S connector strip; for 2001 series; for jumper contact slot; 9-pole; gray

www.wago.com/2001-559**Item no.: 2001-560**

TOPJOB®S connector strip; for 2001 series; for jumper contact slot; 10-pole; gray

www.wago.com/2001-560**Item no.: 2009-174**

TOPJOB®S test plug adapter; for test plug 4 mm Ø; for testing TOPJOB®S terminal blocks; gray

www.wago.com/2009-174**Item no.: 2009-182**

TOPJOB®S testing tap; tool-free; 12 AWG max; for testing TOPJOB®S terminal blocks; gray

www.wago.com/2009-182**End plate****Item no.: 2002-1291**

TOPJOB®S end/intermediate plate; for 2002-12xx series terminal blocks; 0.8 mm wide; gray

www.wago.com/2002-1291**Item no.: 2002-1292**

TOPJOB®S end/intermediate plate; for 2002-12xx series terminal blocks; 0.8 mm wide; orange

www.wago.com/2002-1292**Item no.: 2002-1293**















TOPJOB®S end/intermediate plate; for 2002-12xx series terminal blocks; 2.0 mm wide; gray

www.wago.com/2002-1293**Item no.: 2002-1294**

TOPJOB®S end/intermediate plate; for 2002-12xx series terminal blocks; 2.0 mm wide; orange

www.wago.com/2002-1294

Marking accessories

	Item no.: 2009-110 Marking strips; on reel; not stretchable; plain; snap-on type	www.wago.com/2009-110
	Item no.: 2009-114 WMB-Inline; for smartPRINTER; on reel; stretchable 4 - 4.2 mm; plain; snap-on type	www.wago.com/2009-114
	Item no.: 2009-114/000-002 WMB-Inline; on reel; stretchable 4 - 4.2 mm; plain; snap-on type	www.wago.com/2009-114/000-002
	Item no.: 2009-114/000-005 WMB-Inline; on reel; stretchable 4 - 4.2 mm; plain; snap-on type	www.wago.com/2009-114/000-005
	Item no.: 2009-114/000-006 WMB-Inline; on reel; stretchable 4 - 4.2 mm; plain; snap-on type	www.wago.com/2009-114/000-006
	Item no.: 2009-114/000-007 WMB-Inline; on reel; stretchable 4 - 4.2 mm; plain; snap-on type	www.wago.com/2009-114/000-007
	Item no.: 2009-114/000-012 WMB-Inline; on reel; stretchable 4 - 4.2 mm; plain; snap-on type	www.wago.com/2009-114/000-012
	Item no.: 2009-114/000-023 WMB-Inline; on reel; stretchable 4 - 4.2 mm; plain; snap-on type	www.wago.com/2009-114/000-023
	Item no.: 2009-114/000-024 WMB-Inline; on reel; stretchable 4 - 4.2 mm; plain; snap-on type	www.wago.com/2009-114/000-024
	Item no.: 793-4501 WMB marking card; as card; stretchable 4 - 4.2 mm; plain; snap-on type	www.wago.com/793-4501
	Item no.: 793-4501/000-002 WMB marking card; as card; stretchable 4 - 4.2 mm; plain; snap-on type	www.wago.com/793-4501/000-002
	Item no.: 793-4501/000-005 WMB marking card; as card; stretchable 4 - 4.2 mm; plain; snap-on type	www.wago.com/793-4501/000-005
	Item no.: 793-4501/000-006 WMB marking card; as card; stretchable 4 - 4.2 mm; plain; snap-on type	www.wago.com/793-4501/000-006
	Item no.: 793-4501/000-007 WMB marking card; as card; stretchable 4 - 4.2 mm; plain; snap-on type	www.wago.com/793-4501/000-007
	Item no.: 793-4501/000-012 WMB marking card; as card; stretchable 4 - 4.2 mm; plain; snap-on type	www.wago.com/793-4501/000-012



Item no.: 793-4501/000-017
WMB marking card; as card; stretchable 4 - 4.2 mm; plain; snap-on type

www.wago.com/793-4501/000-017



Item no.: 793-4501/000-023
WMB marking card; as card; stretchable 4 - 4.2 mm; plain; snap-on type

www.wago.com/793-4501/000-023



Item no.: 793-4501/000-024
WMB marking card; as card; stretchable 4 - 4.2 mm; plain; snap-on type

www.wago.com/793-4501/000-024

General accessories



Item no.: 2002-880/1000-411
Diode plug; 1N4007 (N-P); for 2001 - 2006 series feedthrough terminal blocks; 5.2 mm wide; gray

www.wago.com/2002-880/1000-411



Item no.: 2002-880/1000-541
LED plug; red LED (N-P); 12 - 30 V; for 2001 - 2006 series feedthrough terminal blocks; 10.4 mm wide; gray

www.wago.com/2002-880/1000-541



Item no.: 2002-880/1000-542
LED plug; red LED (N-P); 30 - 65 V; for 2001 - 2006 series feedthrough terminal blocks; 10.4 mm wide; gray

www.wago.com/2002-880/1000-542



Item no.: 2002-880/1000-836
LED plug; red LED (N-P); 230 V; for 2001 - 2006 series feedthrough terminal blocks; 10.4 mm wide; gray

www.wago.com/2002-880/1000-836

Jumper



Item no.: 2001-402
TOPJOB®S jumper; for 2001 series; insulated; 2-way; light-gray

www.wago.com/2001-402



Item no.: 2001-403
TOPJOB®S jumper; for 2001 series; insulated; 3-way; light-gray

www.wago.com/2001-403



Item no.: 2001-404
TOPJOB®S jumper; for 2001 series; insulated; 4-way; light-gray

www.wago.com/2001-404



Item no.: 2001-405
TOPJOB®S jumper; for 2001 series; insulated; 5-way; light-gray

www.wago.com/2001-405



Item no.: 2001-405/011-000
TOPJOB®S jumper; Wye configuration; for 2001 series; insulated; 3-way (1-3-5); light-gray

www.wago.com/2001-405/011-000



Item no.: 2001-406
TOPJOB®S jumper; for 2001 series; insulated; 6-way; light-gray

www.wago.com/2001-406





















Item no.: 2001-406/020-000
TOPJOB®S jumper; Delta configuration; for 2001 series; insulated; 6-way (1-2, 3-4, 5-6); light-gray

www.wago.com/2001-406/020-000

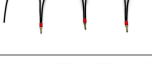

Item no.: 2001-407
TOPJOB®S jumper; for 2001 series; insulated; 7-way; light-gray

www.wago.com/2001-407

	Item no.: 2001-408 TOPJOB®S jumper; for 2001 series; insulated; 8-way; light-gray	www.wago.com/2001-408
	Item no.: 2001-409 TOPJOB®S jumper; for 2001 series; insulated; 9-way; light-gray	www.wago.com/2001-409
	Item no.: 2001-410 TOPJOB®S jumper; for 2001 series; insulated; 10-way; light-gray	www.wago.com/2001-410
	Item no.: 2001-433 TOPJOB®S jumper; for 2001 series; insulated; 2-way (1-3); light-gray	www.wago.com/2001-433
	Item no.: 2001-434 TOPJOB®S jumper; for 2001 series; insulated; 2-way (1-4); light-gray	www.wago.com/2001-434
	Item no.: 2001-435 TOPJOB®S jumper; for 2001 series; insulated; 2-way (1-5); light-gray	www.wago.com/2001-435
	Item no.: 2001-436 TOPJOB®S jumper; for 2001 series; insulated; 2-way (1-6); light-gray	www.wago.com/2001-436
	Item no.: 2001-437 TOPJOB®S jumper; for 2001 series; insulated; 2-way (1-7); light-gray	www.wago.com/2001-437
	Item no.: 2001-438 TOPJOB®S jumper; for 2001 series; insulated; 2-way (1-8); light-gray	www.wago.com/2001-438
	Item no.: 2001-439 TOPJOB®S jumper; for 2001 series; insulated; 2-way (1-9); light-gray	www.wago.com/2001-439
	Item no.: 2001-440 TOPJOB®S jumper; for 2001 series; insulated; 2-way (1-10); light-gray	www.wago.com/2001-440
	Item no.: 2006-499 Step-down jumper; insulated; from 6/4 mm ² to 4/2.5/1.5 mm ² ; Nominal current 32 A	www.wago.com/2006-499
	Item no.: 2009-412 TOPJOB®S wire jumper; insulated; 60 mm long; conductor cross section 1.5 mm ² ; suitable for 2001, 2002, 2003 and 2022 series terminal blocks; gray	www.wago.com/2009-412
	Item no.: 2009-414 TOPJOB®S wire jumper; insulated; 110 mm long; conductor cross section 1.5 mm ² ; suitable for 2001, 2002, 2003 and 2022 series terminal blocks; gray	www.wago.com/2009-414
	Item no.: 2009-416 TOPJOB®S wire jumper; insulated; 250 mm long; conductor cross section 1.5 mm ² ; suitable for 2001, 2002, 2003 and 2022 series terminal blocks; gray	www.wago.com/2009-416
	Item no.: 210-103 Wire commoning chain; insulated; 50 connections	www.wago.com/210-103
	Item no.: 210-123 Wire commoning chain; insulated; 50 connections	www.wago.com/210-123
tools		
	Item no.: 210-647 Operating tool with partially insulated shaft; Blade (2.5 x 0.4) mm; short	www.wago.com/210-647
	Item no.: 210-648 Operating tool with partially insulated shaft; Blade (2.5 x 0.4) mm; short; angled	www.wago.com/210-648



Item no.: 210-719

Operating tool with partially insulated shaft; Type 1, blade (2.5 x 0.4) mm

www.wago.com/210-719

Downloads

Documentation

Bid Text

2201-1201	15.8.2018	DOCX 15.0 kB	Download
-----------	-----------	-----------------	----------

CAD files

CAD data

3D Download 2201-1201	Download
-----------------------	----------

Subject to changes.