



SGX

SENSORTECH

An Amphenol Company



PS1-VOC-200-MOD

Total Volatile Organic Compound Module Datasheet

Small size | Low cost | Long life | Fast response | High accuracy | Low power consumption



Quality, Safety, Responsibility

Product note

The PS1 series VOC gas module is the perfect combination of our sensor with an advanced printed circuit board. SGX Sensortech gas sensors are using a revolutionary 'Solid Polymer Electrolyte' technology that is based on the principle of electrochemical reaction. The target gas to be measured generates a very small current, proportional to the gas concentration. Our technology offers a stable, high quality and cost-effective manufacturing process.

The module is equipped with a standard UART digital output, allowing operation by anyone without knowledge or understanding of the sensor application and the tedious work of calibration.

Features

- High accuracy and long life
- Fast response speed, fast return to zero, plug and play
- Good anti-toxicity
- Easy to use, UART digital signal output
- Excellent accuracy, repeatability, linearity and consistency
- Zero drift
- Strong anti-electromagnetic interference
- Mounting holes for easy installation
- Sleep function for low power applications
- Independent temperature and humidity digital sensor output
- RoHS compliant

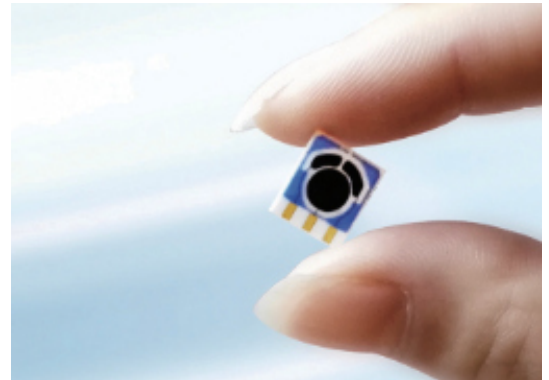

Application

- Indoor gas monitoring
- Air purifier
- Air Pollution Monitoring in Commercial Places
- Indoor temperature and humidity monitor
- Air monitoring in public transport spaces
- HVAC systems
- Laboratory fume hood system
- Laboratory environment monitoring
- Ambient air quality monitoring



Cross Sensitivity

Gas	Formula	Test Concentration	Sensor Reading
Acetic acid	CH ₃ COOH	5ppm	1.1ppm
Acetylene	C ₂ H ₂	/	Responded well
Acrylonitrile	C ₃ H ₃ N	/	Responded well
Ammonia	NH ₃	5ppm	1.5ppm
Benzene	C ₆ H ₆	5ppm	1.1ppm
Butadiene	C ₄ H ₆	/	Responded well
Carbon disulfide	CS ₂	5ppm	1.23ppm
Carbon monoxide	CO	5ppm	3.38ppm
Dimethyl Disulfide	C ₂ H ₆ S ₂	2ppm	6.8ppm
Dining lampblack (dimensionless)	Unsaturated hydrocarbons	/	Responded well
Ethanol	C ₂ H ₆ O	5ppm	1.83ppm
Ethylene	C ₂ H ₄	5ppm	3.16ppm
Ethylene oxide	C ₂ H ₄ O	5ppm	3.83ppm
Formaldehyde	HCHO	5ppm	6ppm
Formic acid	HCOOH	5ppm	5.36ppm
Gasoline volatilization (dimensionless)	Aliphatic hydrocarbons, cycloalkanes, aromatic hydrocarbons	/	Responded well
Hydrogen	H ₂	5ppm	1.15ppm
Hydrogen chloride	HCl	5ppm	0.27ppm
Hydrogen cyanide	HCN	5ppm	0.36ppm
Isobutene	C ₄ H ₈	5ppm	5ppm
Methanol	CH ₃ OH	5ppm	5.95ppm
Methyl mercaptan	CH ₄ S	5ppm	7ppm
Methyl sulfide	C ₂ H ₆ S	5ppm	8.97ppm
Nitrogen dioxide	NO ₂	5ppm	1.86ppm
O-xylene	C ₈ H ₁₀	5ppm	0.58ppm
Styrene	C ₈ H ₈	0.5ppm	7.5ppm
Toluene	C ₇ H ₈	5ppm	0.81ppm
Trimethylamine	C ₃ H ₉ N	5ppm	0.65ppm

Note: 1) The above interference factors may be different due to different sensors and service life, please refer to the actual test results.
2) This table is not complete for all gases, and the sensor may be sensitive to other gases.

Specification

Principle	Solid Polymer Electrochemical Sensing Technology
Detection of gas	VOC organic volatile gas
Detection Range	0-200ppm; Resolution: 0.1ppm
Lowest Detection Limit	1ppm
Full-scale accuracy error	± 5% F.S
Repeatability	<2%
Settling time	The first power-on under storage in clean air <120 seconds The first power-up under storage in non-clean air <240 seconds (except in the presence of high concentrations of polluted gas)
Response time	T90: <20 seconds;
Zero return time	<80 seconds Note: The module is separated from the measured gas environment, in clean air, the displayed value returns to 0.03ppm or less
Calibration Gas	200ppm measurement range: 100ppm isobutylene gas calibration; Note: The gas distribution standard uses clean air as the background gas, the humidity is 50%, and the normal temperature environment
Sensor expected life time	More than three years in Relatively clean air, temperature 0-25 ° C, humidity 30-70% (Sensor life will be reduced if often exposed to corrosive gas, high temperature environment and <20% low humidity environment)
Output	The standard output is: 3.3V UART digital signal (see below for communication protocol) ; Optional custom Modbus protocol Interface definition: VCC- Red, GND- Black, RX- Yellow, TX- Green; Baud rate: 9600 Data bits: 8 bits Stop bits: 1 bit
Get data command	The communication is divided into active uploading and Q & A. The default is Q & A mode after power-on. You can use instructions to switch between the two modes. Return to Q & A mode after power off or switch power mode See next page for details
Working Voltage	3.3-5.5V DC
Working Current	< 5mA
Power Consumption	25mW @ 5V DC
Working temperature	-40°C - 55°C
Optimal working temperature	(20 - 35) °C
Working humidity	(15-95) %RH. (Non-condensing)
Optimum working humidity	50% RH.
Working pressure	Atm ± 10%
Board size	40 x 30 x 5.6 (mm)
Board size with sensor	40 x 30 x 12 (mm)
Weight	< 15g
Temperature and humidity sensor Data	Temperature Range: (-40~85) °C Relative error: ± 0.2 °C Humidity measurement range: (10 ~ 95)% RH non-condensing Relative error: ± 2%
Warranty	12 months from the date of shipment

Structure Diagram (unit in mm)

PS1-CH4S-100-MOD Dimension diagram

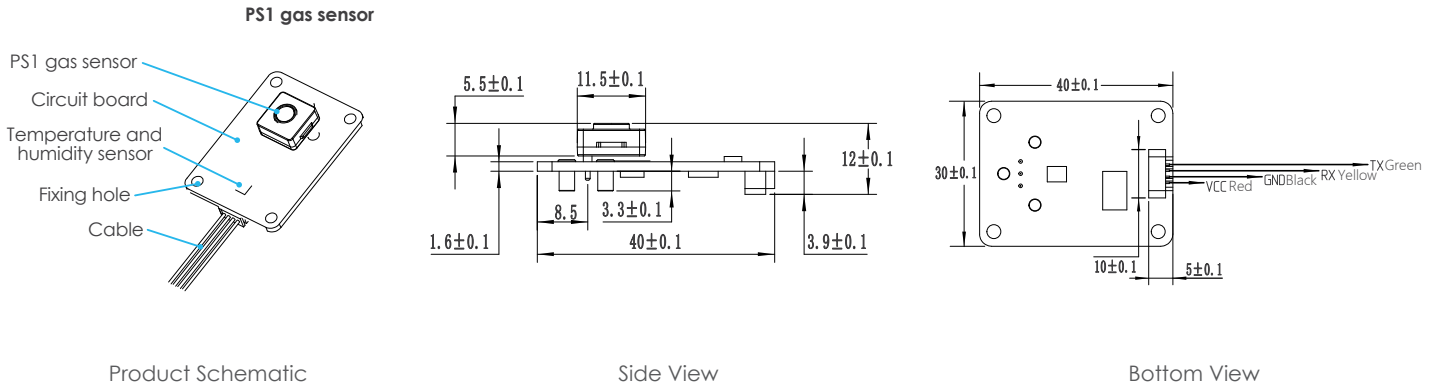

MOD-4Pin-Cable Dimensions (mm)

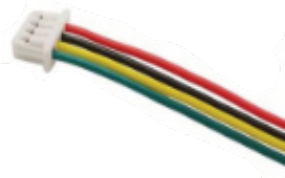
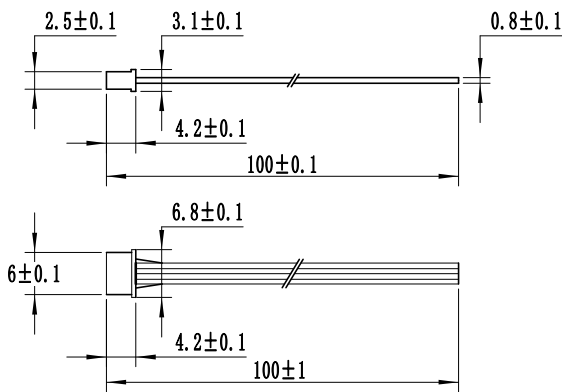

Cable color	Signal
Red	VCC
Black	GND
Yellow	RX
Green	TX

EK6-PSX Evaluation Kit

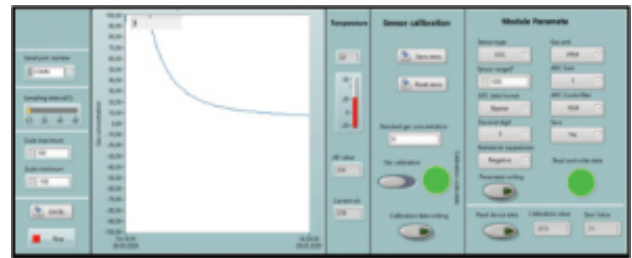

The main purpose of the Evaluation Kit is to install software that allows the user to read data from SGX Sensortech sensor module boards.

We offer an Evaluation Kit for all of our sensor modules. The Evaluation Kit includes a USB UART interface and comes with a USB to TTL adapter and cable. In addition, the kit includes easy-to-use testing software that can be installed on any PC, allowing you to test and equally get familiar with our product.

The software displays data from the sensor modules and can be exported. Therefore, it can only read data from the sensor module and cannot write data to it. All of the SGX Sensortech products are delivered factory calibrated.

Linearity

Temperature environment: 26°C ; Humidity environment: 55%; Air chamber space: 0.03m³; Ventilation flow of air distribution system: 3000scm

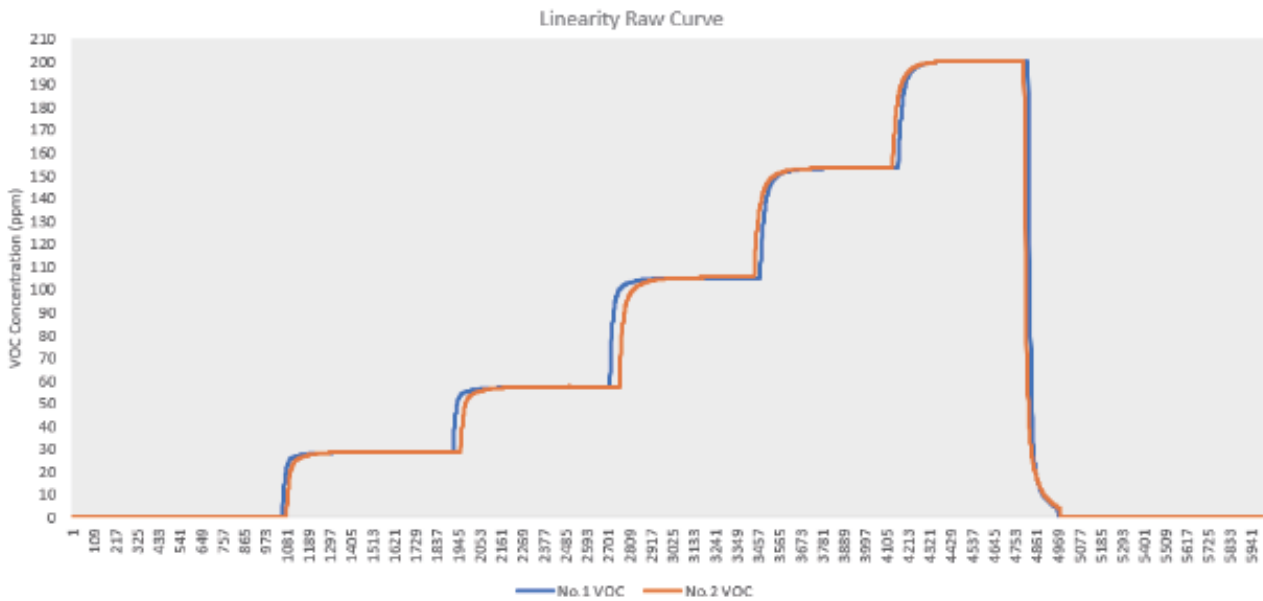

Repeatability

Temperature environment: 26°C ; Humidity environment: 55%; Gas chamber space: 0.03m³ Gas flow of gas; Distribution system: 3000scm

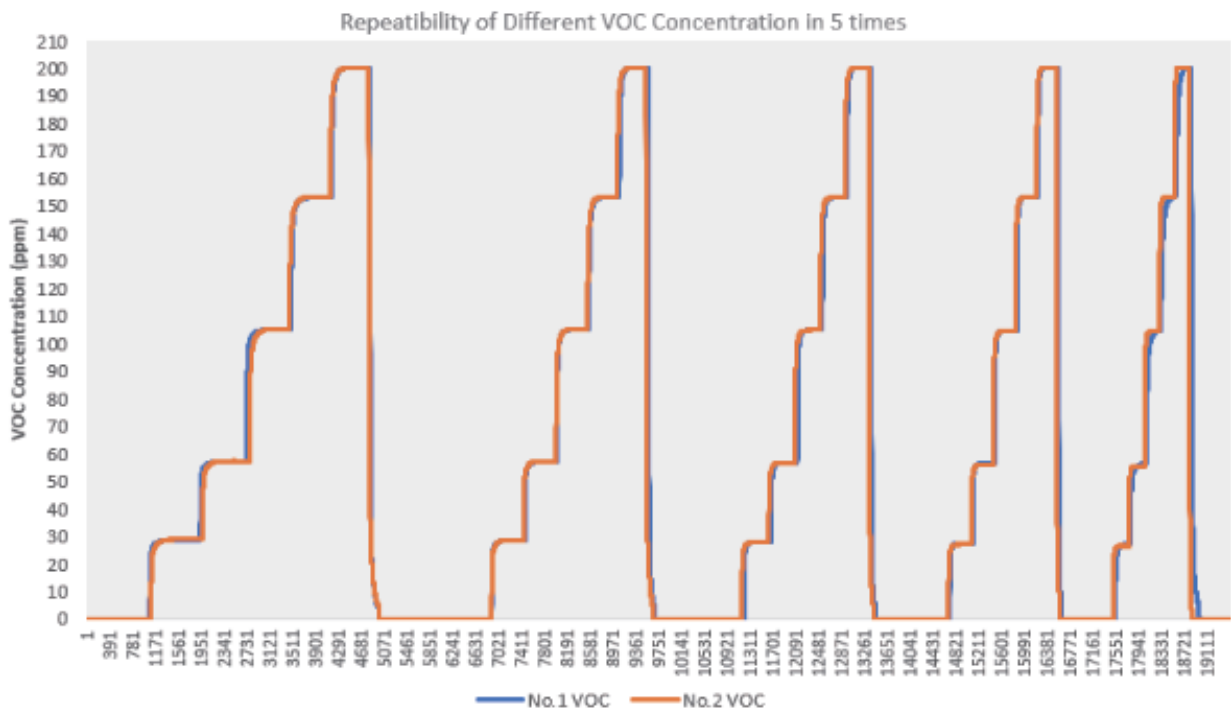

Temperature

Temperature environment: -15, -5, 5, 15, 25, 35, 45, 55°C; air chamber space: 0.03m³; Ventilation flow of gas distribution system: 3000scm

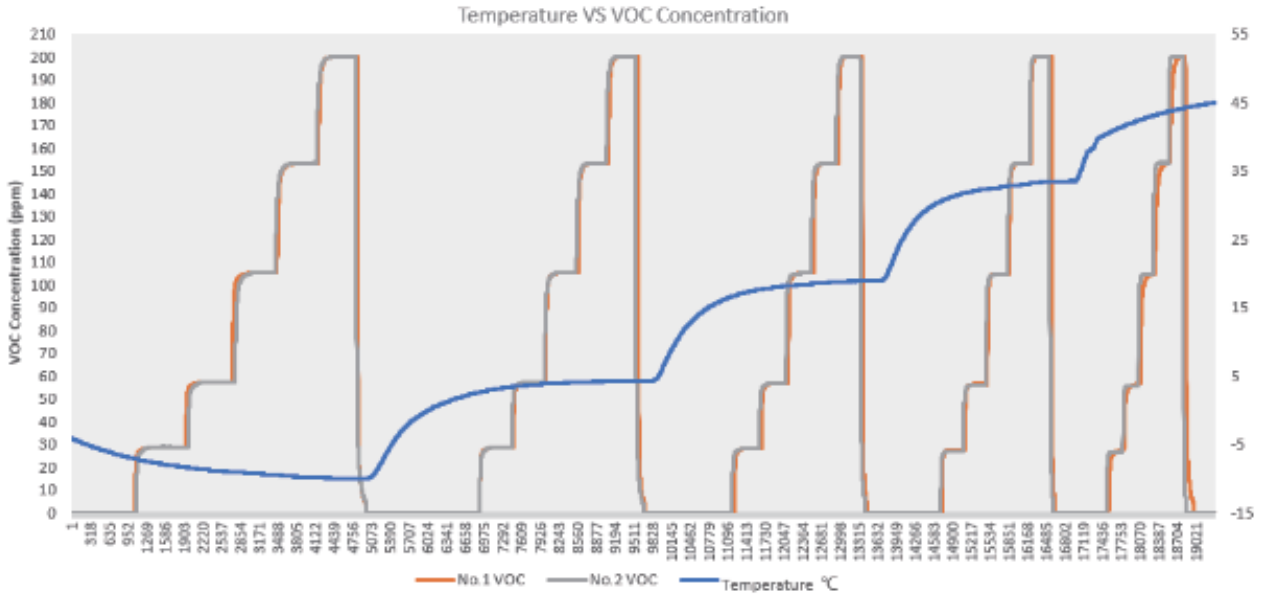

User Guide

Thank you for choosing SGX Sensortech module. Before using it, please read this document in detail in order to use our products correctly and effectively.

Storage

The solid polymer sensor can be stored for more than 1 year at a humidity of 25%-95%(non-condensing) and a temperature of -5-25°C . Ensure that the storage environment is free from high concentrations of contaminated gases.

1. The storage environment should be clean air, no pollution gas, no high concentration organic gas, no dust, no smoke;
2. Avoid storage with alcohol (ethanol), perfume, sodium silicate, and polyurethane liquids and solids.

Packing and shipping

1. Avoid prolonged direct sunlight during transportation, prevent rainwater penetration;
2. Transport packaging should be protected by Shock-proof bubble film or non-odor environmentally friendly sponge;
3. During long-term long-distance transportation, the temperature in the sensor package should be kept below 40°C as much as possible, and the maximum temperature should not exceed 55°C;
4. During the transportation of your finished product, seal the air inlet of the sensor as much as possible to prevent the contaminated gas from entering the sensor, as this could cause a too high reading and a longer stabilization time when you use the product for the first time.

Steps for usage

1. Wiring

- Use the the corresponding wiring according to the drawing. For the power supply, see the voltage and current ranges marked in the specification.

Note: incorrect wiring will cause the module to malfunction or be damaged.

2. Stable time

- The sensor module needs a short stabilization time after power-on. The module is designed with plug-and-play function, and usually the stabilization time is within 2 minutes. However, if the concentration of the contaminated gas is high during storage, transportation or on-site environment, the stabilization time will increase. If the on-site ambient air is highly fluid, there will be fluctuations in the data. Please pay close attention to the on-site environment status and make sure this is stable and there is no strong convection and air exchange, such as opening windows, opening doors, fans, air conditioners, fresh air systems, etc., As soon as the output signal is constant, the detection can begin.

3. Diffusion use

- The airflow naturally diffuses into the sensor. When the environment has a flow rate, it is necessary to ensure that the flow rate is within 500ml and that it is stable. A change of flow will cause the signal to fluctuate. The flow velocity will generate pressure, and the change in pressure will cause the output signal to change. The signal will increase when the pressure increase and the sensor signal will change when the pressure change suddenly. Avoid a negative pressure environment, which will cause physical damage to the sensor module.

4. Temperature and humidity effects

- The module has been corrected for temperature compensation through an intelligent algorithm, which is suitable for a environment of -40 - 55°C . There will be detection values in the temperature range outside of the temperature compensation, but deviation is large. If you have a special requirements, please contact our factory.
- The sensor is not affected by normal humidity changes, but rapid humidity changes will cause instantaneous signal peak changes, mainly due to condensation on the sensor surface. This will prevent outside air from entering the sensor. Frequent and rapid changes in temperature or humidity will affect the chemical materials and cause the sensor life to be reduced. Due to the principle and characteristics of electrochemical sensors, changes in the environment have different levels of influence on the chemical electrolyte inside the sensor. The SGX Sensortech sensor module analyzes the changes of the sensor data in detail through different environmental temperature and humidity impact tests, and combines the temperature and humidity sensor data to perform algorithmic compensation. During the use of the sensor, pay attention to the sudden changes in temperature and humidity, as this will cause the sensor data to fluctuate abnormally. The sensor module has good adaptability to the environment. Generally, it can fully adapt to the new environment and stabilize in 5-10 minutes.
- The sensor module must not be used and stored for a longer time in a high-temperature(>55°C) and low-humidity (<10%RH) environment. Failure to do so may result in reduced sensor life, failure or invalid test data.

User Guide

Precautions

1. The main function of the sensor module is to detect the gas composition and content. Please do not let any part of the sensor contact a liquid;
2. Different gas sensors have different measurement concentration ranges. Do not measure high-concentration gases for a long time during use;
3. The white or yellow filter on the sensor is a waterproof and breathable film, please be careful not to scratch or pull it off;
4. Do not block or contaminate the surface of the sensor. Sometimes the blockage of the hole is the cause of reduced sensitivity and slow response time;
5. Please do not exchange the sensors on the module. Doing so will cause measurement errors, because the parameters of each sensor and circuit board are matched and calibrated.
6. In the case that the sensor is unplugged and be re-inserted into the module, please check that the three electrodes of the sensor correspond to the socket on the circuit board correctly to avoid irreversible damage to the sensor after reverse insertion;
7. Avoid excessive impact or vibration to the module as this could damage it and the output signal will no longer be realible
8. Pins must not be broken or bent. Doing so may damage the internal structure of the sensor;
9. The module is slow to return to it's initial state after long-term use in a high-concentration gas environment. The speed of recovery is proportional to the overrange multiple;
10. Low range sensor module(<10 ppm) should avoid high concentration gas for longer times;
11. Please do not disassemble the sensor from the module as this will cause damage;
12. Measurement range and accuracy. Select the gas sensor module that matches the range and accuracy according to the application.
13. When conducting on-site detection of the target gas, avoid the interference of other high-concentration gases as this will cause the error rate of the test results to increase.
14. Due to the principle and characteristics of the electrochemical sensor, in order to ensure the long life and the best working state of the sensor, the sensor should be kept in a continuous power-on state as much as possible;
15. When the sensor module encounters high-concentration gases during use, such as the target gas, ethanol gas, and volatile organic gas, the recovery time might be slower. Placement in a clean air environment will shorten the recovery time.

DISCLAIMER:

SGX Europe Sp. z o.o. reserves the right to change design features and specifications without prior notification. We do not accept any legal responsibility for customer applications of our sensors. SGX Europe Sp. z o.o. accepts no liability for any consequential losses, injury or damage resulting from the use of this document, the information contained within or from any omissions or errors herein. This document does not constitute an offer for sale and the data contained is for guidance only and may not be taken as warranty. Any use of the given data must be assessed and determined by the user thereof to be in accordance with federal, state and local laws and regulations. All specifications outlined are subject to change without notice.

SGX Europe Sp. z o.o. sensors are designed to operate in a wide range of harsh environments and conditions. However, it is important that exposure to high concentrations of solvent vapours is to be avoided, both during storage, fitting into instruments and operation. When using sensors on printed circuit boards (PCBs), degreasing agents should be used prior to the sensor being fitted. SGX Europe Sp. z o.o. makes every effort to ensure the reliability of its products. Where life safety is a performance requirement of the product, we recommend that all sensors and instruments using these sensors are checked for response to gas before use.

Copyright© 2012-2024 SGX Sensortech All rights reserved.

Trademarks and registered trademarks are the property of their respective owners.

No part of this publication may be reproduced, distributed, or transmitted in any form or by any means, including photocopying, recording, or other electronic or mechanical methods, without the prior written permission of the publisher, except in the case of brief quotations embodied in critical reviews and certain other non-commercial uses permitted by copyright law.

For permission requests or technical support please contact or write to the publisher, addressed "Attention: Permissions Coordinator,".

Communication Protocol

General settings

The sensor module uses serial communication. The communication configuration parameters are as follows:

Baud rate	9600
Data bits	8 bits
Stop bit	1 bit
Parity bit	None

Note: The communication is divided into active uploading and Q & A mode. The default mode is Q & A mode after power-on. You can use commands to switch between the two modes. After power-off or switching power consumption mode, the mode is restored.

Transmission mode switching instruction

Command 1 Instruction one switches to active upload. The command line format is as follows:

0	1	2	3	4	5	6	7	8
Start bit	Retain	Switch command	Automatic upload	Retain	Retain	Retain	Retain	Proof test value
0 x FF	0 x 01	0 x 78	0 x 40	0 x 00	0 x 00	0 x 00	0 x 00	0 x 47

Note: This format is fixed

Command 2 Switch to passive upload. The command line format is as follows:

0	1	2	3	4	5	6	7	8
Start bit	Retain	Switch command	Answer	Retain	Retain	Retain	Retain	Proof test value
0 x FF	0 x 01	0 x 78	0 x 41	0 x 00	0 x 00	0 x 00	0 x 00	0 x 46

Note: This format is fixed

Get module information instruction

Command 3 Gets sensor type, maximum range, unit, unit decimal places command: 0xD1
Returned value:

0	1	2	3	4	5	6	7	8
Sensor type	Maximum range high	Maximum range low	Unit	Retain	Retain	Retain	Number of decimal places (bit[4]~bit[7]) Data sign (bit[0]~bit[3])	Parity bit
0 x 23	0 x 00	0 x CB	0 x 02	0 x 00	0 x 00	0 x 00	0 x 00	0 x 35

Note:

Max range = (Max range high << 8) | Max range low

Units: 0x02 (ppm and mg / m³) 0x04 (ppb and ug / m³)

Signs: 0 (positive number) 1 (negative number)

Decimal places: how many decimal places to read the concentration value, the maximum number of decimal places is 3

Communication Protocol

Command 4 Get the sensor type, maximum range, unit, and decimal places command: 0xD7

0	1	2	3	4	5	6	7	8
Command header 1	Command header 2	Sensor type	Maximum range high	Maximum range low	Unit	Number of decimal places (bit[4]~bit[7]) Data sign (bit[0]~bit[3])	Retain	Parity bit
0 x FF	0 x D7	0 x 23	0 x 00	0 x C8	0 x 02	0 x 01	0 x 00	0 x 3B

Explanation:

Checksum: 1 ~ 7 bits of data are added to generate an 8-bit data.invert every bit and add 1 to the end

Decimal places bit [4] ~ bit [7]:

$(\text{bit}[7] \ll 3) \mid (\text{bit}[6] \ll 2) \mid (\text{bit}[5] \ll 1) \mid \text{bit}[4]$ = decimal places

Data sign (bit[0]~bit[3]):

$(\text{bit}[3] \ll 3) \mid (\text{bit}[2] \ll 2) \mid (\text{bit}[1] \ll 1) \mid \text{bit}[0]$ = 0 Negative inhibition

$(\text{bit}[3] \ll 3) \mid (\text{bit}[2] \ll 2) \mid (\text{bit}[1] \ll 1) \mid \text{bit}[0]$ = 1 Positive inhibition

Unit :

0x02: unit is mg/m³ and ppm

0x04: unit is um/m³ and ppb

0x08: unit is 10g/m³ and %

Command 5 The format for actively reading the gas concentration value is as follows :

0	1	2	3	4	5	6	7	8
Start bit	Retain	Command	Retain	Retain	Retain	Retain	Retain	Parity bit
0 x FF	01	0 x 86	0 x 00	0 x 00	0 x 00	0 x 00	0 x 00	0 x 79

Returned value:

0	1	2	3	4	5	6	7	8
Start bit	Command	High gas concentration (ug/m ³)	Low gas concentration (ug/m ³)	Full range high	Full range low	High gas concentraton (ppb)	Low gas concentraton (ppb)	Parity bit
0 x FF	0 x 86	0 x 00	0 x 2A	0 x 00	0 x 00	0 x 00	0 x 20	0 x 30

Description:

Checksum: 1 ~ 7-bit data is added to generate an 8-bit data.invert every bit and add 1 to the end

Gas concentration value = high gas concentration *256 + low gas concentration ;

(The high and low concentrations need to be converted from hexadecimal to decimal and then brought into this formula to calculate

Communication Protocol

Command 6 Gas concentration value and temperature and humidity combined reading instruction

0	1	2	3	4	5	6	7	8
Start bit	Retain	Command	Retain	Retain	Retain	Retain	Retain	Parity bit
0 x FF	0 x 00	0 x 87	0 x 00	0 x 00	0 x 00	0 x 00	0 x 00	0 x 79

Returned value:

0	1	2	3	4	5	6	7	8	9	10	11	12
Start bit	Command	High gas concentration (ug/m ³)	Low gas concentration (ug/m ³)	Full range high	Full range low	High gas concentration (ppb)	Low gas concentration (ppb)	Temperature high	Temperature low	Humidity high	Humidity low	Parity bit
0 x FF	0 x 87	0 x 00	0 x 2A	0 x 03	0 x E8	0 x 00	0 x 20	0 x 09	0 x C4	0 x 13	0 x 88	0 x DC

Description:

Checksum: 1 ~ 11 bits of data are added to generate an 8-bit data, each bit is inverted, and 1 is added at the end.

Gas concentration value = high gas concentration * 256 + low gas concentration;

(The high and low concentrations need to be converted from hex) adecimal to decimal and then brought into this formula to calculate

Temperature is signed data with two decimal places (°C-Celsius) Pseudo code calculation formula:

$$T = (\text{float})((\text{int})((0x0A \ll 8) | 0x09)) / 100$$

Humidity is data without signs and two decimal places. The unit is (rh%). Pseudo code calculation formula:

$$Rh = (\text{float})((\text{uint})((0x0A \ll 8) | 0x09)) / 100$$

Command 7 Get the current temperature and humidity

Returned value:

0	1	2	3
Temperature high 8 bit	Temperature low 8 bit	Humidity high 8 bit	Humidity low 8 bit
0 x 0A	0 x 09	0 x 11	0 x F4

Description:

Temperature is signed data with two decimal places and the unit is (°C-Celsius)

Pseudo code calculation formula:

$$T = (\text{float})((\text{int})((0x0A \ll 8) | 0x09)) / 100$$

Humidity is data without sign and two decimal places, the unit is (rh%)

Pseudo code calculation formula:

$$Rh = (\text{float})((\text{uint})((0x0A \ll 8) | 0x09)) / 100$$

Communication Protocol

Command 8 Get the current temperature and humidity with calibration
Returned value:

0	1	2	3	4
Temperature high 8 bit	Temperature low 8 bit	Humidity high 8 bit	Humidity low 8 bit	Checksum
0 x 0A	0 x 09	0 x 11	0 x F4	0 x E8

Description:

Checksum: 0 ~ 3 digits of data are added to generate an 8-bit data. Each bit is inverted, plus 1 at the end
Temperature is data with a sign and two decimal places. The unit is (°C-Celsius)

Pseudo code calculation formula:

$$T = (\text{float})((\text{int})((0x0A \ll 8) | 0x09)) / 100$$

Humidity is data with no sign and two decimal places in units (rh%).

Pseudo code calculation formula:

$$Rh = (\text{float})((\text{uint})((0x0A \ll 8) | 0x09)) / 100$$

Command 9 Get the current version number
Returned value:

0	1	2	3	4	5
0 x 19	0 x 05	0 x 27	0 x 00	0 x 10	0 x 01

Data in active upload mode

The upload data format is as follows:

0	1	2	3	4	5	6	7	8
Start bit	Command	High gas concentration (ug/m ³)	Low gas concentration (ug/m ³)	Full range high	Full range low	High gas concentration (ppb)	Low gas concentration (ppb)	Parity bit
0 x FF	0 x 86	0 x 00	0 x 2A	0 x 00	0 x 00	0 x 00	0 x 20	0 x 30

Note:

Checksum: Add 1 to 11 digits of data to generate 8 digits of data, invert each bit, add 1 at the end

Gas concentration value = high gas concentration * 256 + low gas concentration

(The high and low concentrations need to be converted from hexadecimal to decimal and then brought into this formula to calculate)

Low power switching

Enter sleep mode

0	1	2	3	4	5
0 x AF	0 x 53	0 x 6C	0 x 65	0 x 65	0 x 70

Returned value :

0	1
0 x 4F	0 x 4B

Communication Protocol

Exit sleep mode

0	1	2	3	4
0 x AE	0 x 45	0 x 78	0 x 69	0 x 74

Returned value :

0	1
0 x 4F	0 x 4B

Note: after exiting sleep mode, it takes 5 seconds to recover, no data within 5 seconds

Enter sleep mode

0	1	2	3	4	5	6
0 x A1	0 x 53	0 x 6C	0 x 65	0 x 65	0 x 70	0 x 32

Returned value :

0	1	2	3	4	5	6	7	8
0 x FF	0 x A1	0 x 00	0 x 00	0 x 00	0 x 00	0 x 00	0 x 00	5F

Exit sleep mode

0	1	2	3	4	5
0 x A2	0 x 45	0 x 78	0 x 69	0 x 74	0 x 32

Returned value :

0	1	2	3	4	5	6	7	8
0 x FF	0 x A2	0 x 00	0 x 00	0 x 00	0 x 00	0 x 00	0 x 00	5E

Communication Protocol

Turn off the running lights

0	1	2	3	4	5	6	7	8
Start bit	Retain	Command	Retain	Retain	Retain	Retain	Retain	Checksum
0 x FF	0 x 01	0 x 88	0 x 00	0 x 00	0 x 00	0 x 00	0 x 00	0 x 77

Return :

0	1
0 x 4F	0 x 4B

Turn on the running lights

0	1	2	3	4	5	6	7	8
Start bit	Retain	Command	Retain	Retain	Retain	Retain	Retain	Checksum
0 x FF	0 x 01	0 x 89	0 x 00	0 x 00	0 x 00	0 x 00	0 x 00	0 x 76

Return :

0	1
0 x 4F	0 x 4B

Query the running light status

0	1	2	3	4	5	6	7	8
Start bit	Retain	Command	Retain	Retain	Retain	Retain	Retain	Checksum
0 x FF	0 x 01	0 x 8A	0 x 00	0 x 00	0 x 00	0 x 00	0 x 00	0 x 75

Return :

0	1	2	3	4	5	6	7	8
Start bit	Command	State value	Retain	Retain	Retain	Retain	Retain	Checksum
0 x FF	0 x 8A	0 x 01	0 x 00	0 x 00	0 x 00	0 x 00	0 x 00	0 x 75

Note: Status value 1 (light on), 0 (light off)