

62998-2 ✓ ACTIVE

FASTON | FASTON 250

TE Internal #: 62998-2

Receptacle, 10 – 8 AWG Wire Size, 5 – 8 mm² Wire Size, Mating Tab
Width 6.35 mm [.25 in], Straight, Brass, Tin Plating, FASTON 250,
Quick Disconnects

[View on TE.com >](#)



Terminals & Splices > Quick Disconnects

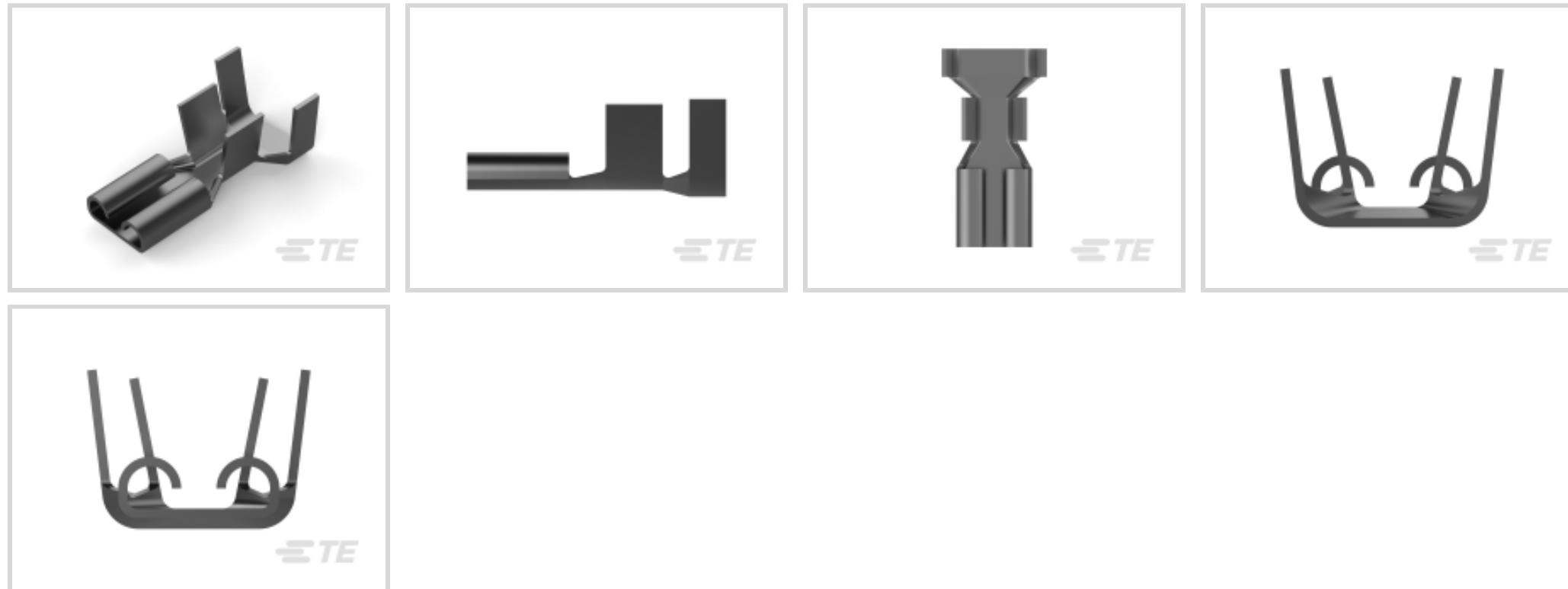

Quick Disconnect Terminal Type: **Receptacle**

Wire Size: **5 – 8 mm²**

Mating Tab Width: **6.35 mm [.25 in]**

Mating Tab Thickness: **.81 mm [.032 in]**

Features

Product Type Features

Insertion Force	Normal
-----------------	--------

Configuration Features

Connection Capacity	Single
---------------------	--------

Compatible With Wire & Cable Type	Discrete Wire
-----------------------------------	---------------

Contact Features

Quick Disconnect Terminal Type	Receptacle
--------------------------------	------------

Mating Tab Width	6.35 mm [.25 in]
------------------	------------------

Mating Tab Thickness	.81 mm [.032 in]
----------------------	------------------

Terminal Orientation	Straight
----------------------	----------

Contact Base Material	Brass
-----------------------	-------

Terminal Plating Material	Tin
---------------------------	-----

Crimp Type	F-Crimp
------------	---------

Barrel Type	Open
-------------	------

Termination Features



Product Terminates To	Wire & Cable
-----------------------	--------------

Mechanical Attachment

Wire Insulation Support	With
Mating Retention Type	Dimple

Dimensions

Terminal Material Thickness	.43 mm[.017 in]
Product Length	19.69 mm[.775 in]
Compatible Insulation Diameter Range	5.84 – 7.11 mm[.23 – .28 in]
Wire Size	5 – 8 mm ²

Usage Conditions

Insulation Option	Uninsulated
Operating Temperature Range	-40 – 110 °C[-40 – 230 °F]

Packaging Features

Packaging Quantity	15000
Packaging Method	Strip/Reel

Other

Line	Premier
------	---------

Product Compliance

[For compliance documentation, visit the product page on TE.com>](#)

EU RoHS Directive 2011/65/EU	Compliant
EU ELV Directive 2000/53/EC	Compliant
China RoHS 2 Directive MIIT Order No 32, 2016	No Restricted Materials Above Threshold
EU REACH Regulation (EC) No. 1907/2006	Current ECHA Candidate List: JUNE 2024 (241) Candidate List Declared Against: JUNE 2024 (241) Does not contain REACH SVHC
Halogen Content	Low Halogen - Br, Cl, F, I < 900 ppm per homogenous material. Also BFR/CFR/PVC Free
Solder Process Capability	Not applicable for solder process capability

Product Compliance Disclaimer

This information is provided based on reasonable inquiry of our suppliers and represents our current actual knowledge based on the information they provided. This information is subject to change. The part numbers that TE has identified as EU RoHS compliant have a maximum concentration of 0.1% by weight in homogenous materials for lead, hexavalent chromium, mercury, PBB, PBDE, DBP, BBP, DEHP, DIBP, and 0.01% for cadmium, or qualify for an exemption to these limits as defined in the Annexes of Directive 2011/65/EU (RoHS2). Finished electrical and electronic equipment products will be CE marked as required by Directive 2011/65/EU. Components may not be CE marked. Additionally, the part numbers that TE has identified as EU ELV compliant have a maximum concentration of 0.1% by weight in homogenous materials for lead, hexavalent chromium, and mercury, and 0.01% for cadmium, or qualify for an exemption to these limits as defined in the Annexes of Directive 2000/53/EC (ELV). Regarding the REACH Regulation, the information TE provides on SVHC in articles for this part number is based on the latest European Chemicals Agency (ECHA) 'Guidance on requirements for substances in articles' posted at this URL: <https://echa.europa.eu/guidance-documents/guidance-on-reach>

Compatible Parts



Also in the Series | FASTON 250

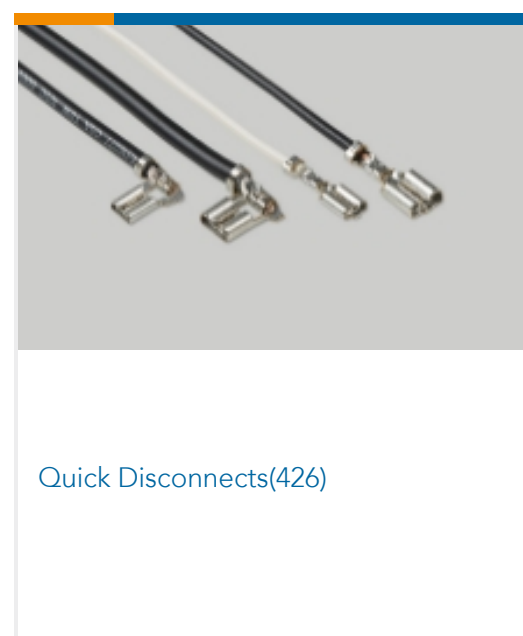
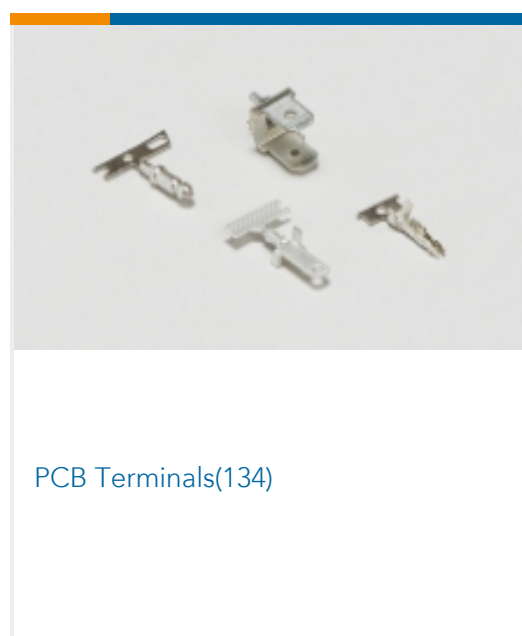
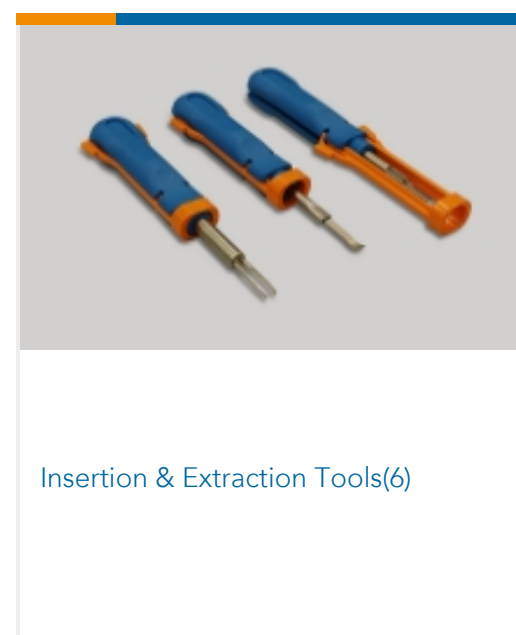
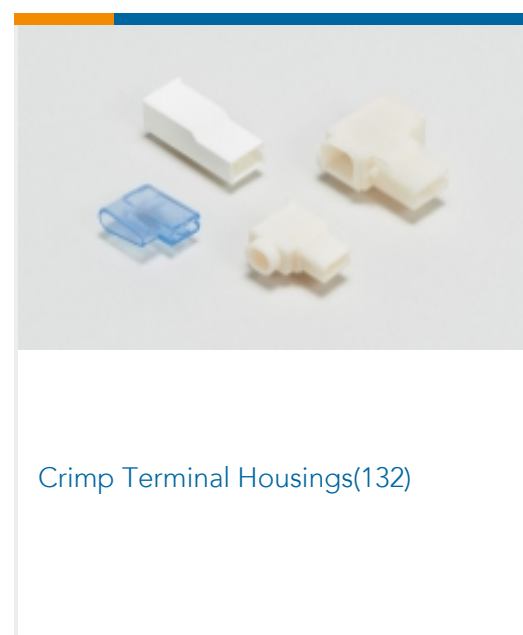
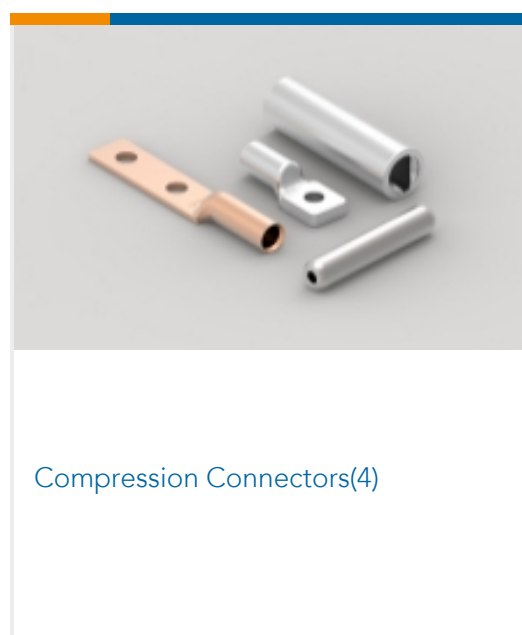

Customers Also Bought



TE Part #E42900-000
HMM-762508-2.5-8A



TE Part #3-1879447-3
TE 200W 470R 5% Bracket



TE Part #52041-1
TERMINAL,R PG 8 1/4

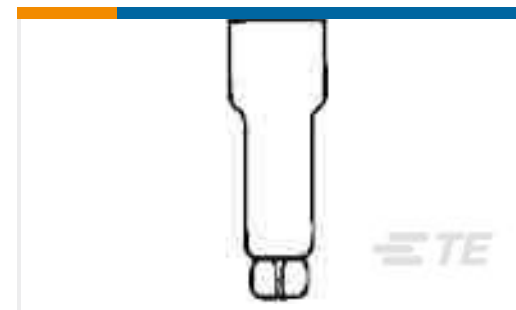

TE Part #1-330021-0
SPLICE,CE ECON 22-16



TE Part #87247-8
08 MODI HDR SRST .156CL



TE Part #CJ4552-000
D-141-30-LF

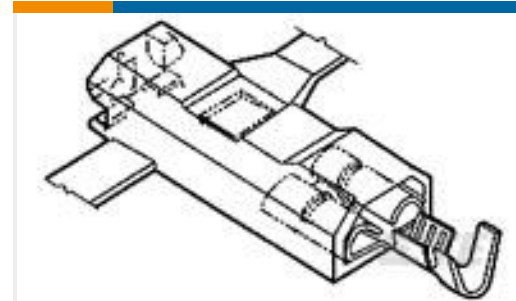

TE Part #521437-2
ULTRA-POD 110 ASSY REC 22-18
AWG TPBR

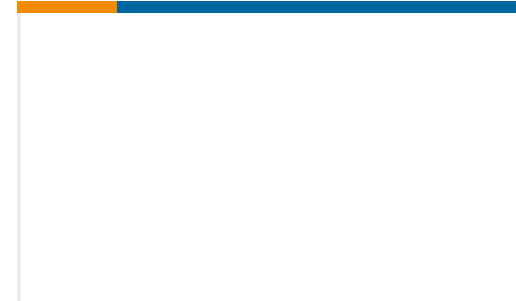

TE Part #520935-9
PL&STANDARD FASTON 250
HOUSING REC BLA



TE Part #647343-3
03P SL156 HSG W/RP TB BLK #2

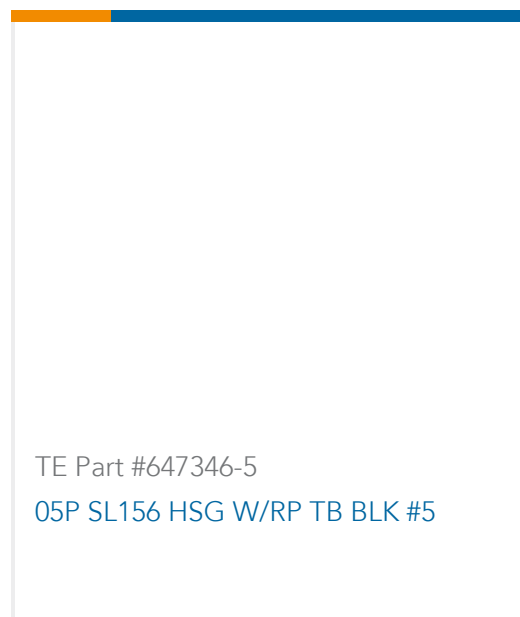

TE Part #647346-5
05P SL156 HSG W/RP TB BLK #5

Documents

Product Drawings

[250 FSATON REC 10-8 AWG TPBR](#)

English

CAD Files

Customer View Model

[ENG_CVM_CVM_62998-2_W.2d_dxf.zip](#)

English

3D PDF

3D

Customer View Model

[ENG_CVM_CVM_62998-2_W.3d_igs.zip](#)

English

Customer View Model

[ENG_CVM_CVM_62998-2_W.3d_stp.zip](#)

English

By downloading the CAD file I accept and agree to the [Terms and Conditions](#) of use.

Datasheets & Catalog Pages



82004 FASTON Terminals (Insulated and Uninsulated) Catalog - FASTON Receptacles Section

English

Product Specifications

Engineering Report

English