

Data sheet | Item number: 2091-1505/002-3000

1-conductor male connector; Gripping plate; direct marking; 1.5 mm²; Pin spacing 3.5 mm; 5-pole; 1,50 mm²; light gray

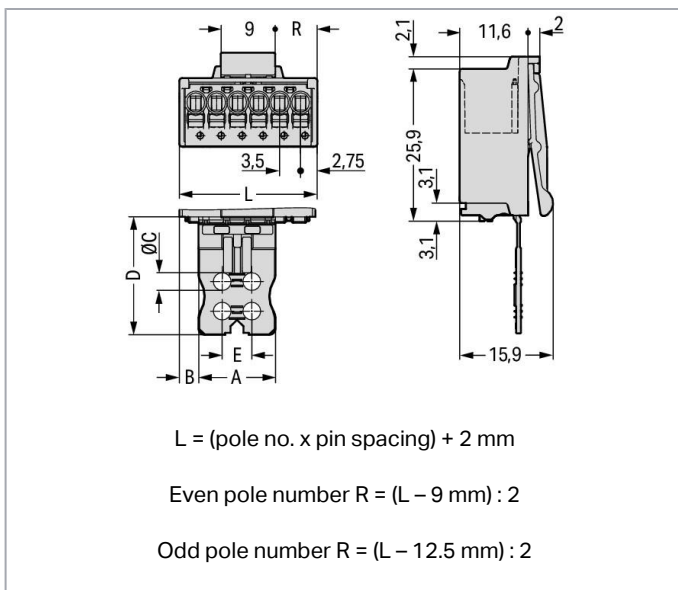

www.wago.com/2091-1505/002-3000

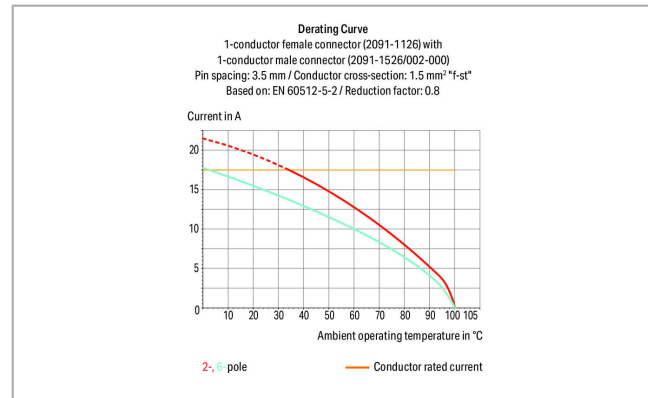
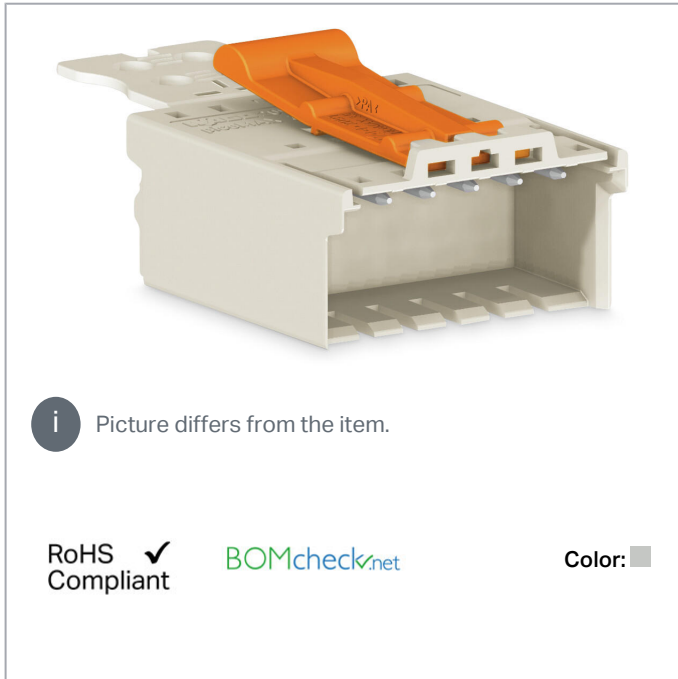

Item description

Subject to changes. Please also observe the further product documentation!

WAGO Kontakttechnik GmbH & Co. KG
Hansastr. 27
32423 Minden
Phone: +49571 887-0 | Fax: +49571 887-169
Email: info.de@wago.com | Web: www.wago.com

Do you have any questions about our products?
We are always happy to take your call at +49 (571) 887-44222.



- Universal connection for all conductor types
- Simple, push-in termination of solid and ferruled conductors
- Easy-to-use design does not require special tools
- Testing parallel to conductor entry – tip contact
- For “wire-to-wire” and “board-to-wire” connections
- Integrated release lever

Safety information 1:

The **picoMAX® Pluggable Connection System** includes connectors without breaking capacity in accordance with DIN EN 61984. When used as intended, these connectors must not be connected/disconnected when live or under load. The circuit design should ensure header pins, which can be touched, are not live when unmated.

Data

Electrical data

Ratings per IEC/EN

Ratings per	IEC/EN 60664-1
Nominal voltage (III/3)	160 V
Rated surge voltage (III/3)	2.5 kV
Rated voltage (III/2)	160 V
Rated surge voltage (III/2)	2.5 kV
Nominal voltage (II/2)	320 V
Rated surge voltage (II/2)	2.5 kV
Rated current	10 A
Legend (ratings)	(III / 2) ≙ Overvoltage category III / Pollution degree 2

Ratings per UL

Approvals per	UL 1059
Rated voltage UL (Use Group B)	300 V
Rated current UL (Use Group B)	10 A
Rated voltage UL (Use Group D)	300 V
Rated current UL (Use Group D)	10 A

Ratings per CSA

Approvals per	CSA
---------------	-----

Subject to changes. Please also observe the further product documentation!



Connection data

Connection technology	Push-in CAGE CLAMP®
Actuation type	Push-button
Solid conductor	0.2 ... 1.5 mm ² / 24 ... 14 AWG
Fine-stranded conductor	0.2 ... 1.5 mm ² / 24 ... 14 AWG
Fine-stranded conductor; with insulated ferrule	0.25 ... 0.75 mm ²
Fine-stranded conductor; with uninsulated ferrule	0.25 ... 1.5 mm ²
Strip length	8 ... 9 mm / 0.31 ... 0.35 inch
Pole No.	5
Total number of connection points	5
Total number of potentials	5
Number of connection types	1
Number of levels	1

Physical data

Pin spacing	3.5 mm / 0.138 inch
Width	17.5 mm / 0.689 inch
Height	15.9 mm / 0.626 inch
Depth	44 mm / 1.732 inch

Mechanical data

Design	With gripping plate
--------	---------------------

Plug-in connection

Contact type (pluggable connector)	Male connector/plug
Connector (connection type)	for conductor
Mismating protection	No
Locking of plug-in connection	Locking latch

Material data

Color	light gray
Material group	I
Insulation material	Polyphthalamide (PPA GF)
Flammability class per UL94	V0
Clamping spring material	Chrome nickel spring steel (CrNi)

Subject to changes. Please also observe the further product documentation!

Contact material	Electrolytic copper (E _{Cu})
Contact plating	tin-plated
Weight	5.4 g

Environmental requirements



Limit temperature range	-60 ... +100 °C
-------------------------	-----------------

Commercial data

Packaging type	BOX
Country of origin	DE
GTIN	4055143622998
Customs tariff number	85366990990

Approvals / Certificates

Country specific Approvals

Logo	Approval	Additional Approval Text	Certificate name
	CB DEKRA Certification B.V.	IEC 61984	NL-49736 /A1
	CSA DEKRA Certification B.V.	C22.2	2362521
	KEMA/KEUR DEKRA Certification B.V.	EN 61984	71- 102260 REV.1

UL-Approvals

Logo	Approval	Additional Approval Text	Certificate name
	UL Underwriters Laboratories Inc.	UL 1977	20190909- E45171

Subject to changes. Please also observe the further product documentation!

Counterpart



Item no.2091-1125

1-conductor female plug; 1.5 mm²; Pin spacing 3.5 mm; 5-pole; 1,50 mm²; light gray

www.wago.com/2091-1125

Compatible products

Coding



Item no.: 2091-1610

Coding key carrier; suitable for 3.5 mm pin spacing; orange

www.wago.com/2091-1610

Downloads

Documentation

Additional Information

Technical explanations	3. 4. 2019	pdf 2.0 MB	Download
------------------------	------------	---------------	----------

Environmental Product Compliance

Compliance Search

Environmental Product Compliance 2091-1505/002-3000	URL	Download
1-conductor male connector; Gripping plate; direct marking; 1.5 mm ² ; Pin spacing 3.5 mm; 5-pole; 1,50 mm ² ; light gray		

Installation Notes

Product family

[*<i>picoMAX</i>[®]* 3.5](#)

[Show all products from the family](#)

Subject to changes. Please also observe the further product documentation!