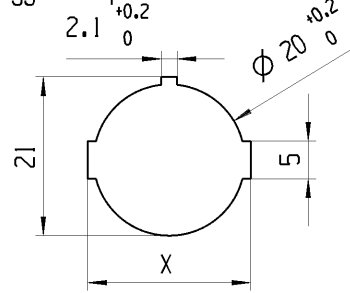

© THIS DRAWING IS THE EXCLUSIVE PROPERTY OF MARQUARDT. WITHOUT THEIR CONSENT IT MAY NOT BE REPRODUCED OR GIVEN TO THIRD PARTIES.

CONFIDENTIAL

VERTRAULICH

© Alle Rechte bei Marquardt, auch fuer den Fall von Schutzrechtsanmeldungen. Jede Veruegungsbefuegnis, wie Kopier- und Weitergaberecht, bei uns.

A	1	2	3	4
	Empfohlener Plattenausschnitt suggested panel cutout	Plattendicke panel thickness	X	
		0.75-1.25 1.25-2.00 2.00-3.00	21.2 -0.1 21.4 -0.1 21.8 -0.1	

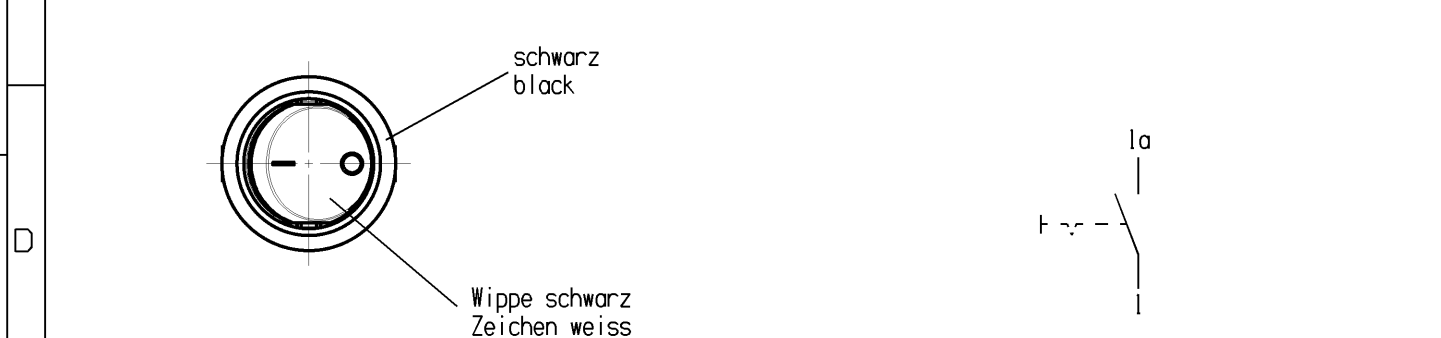
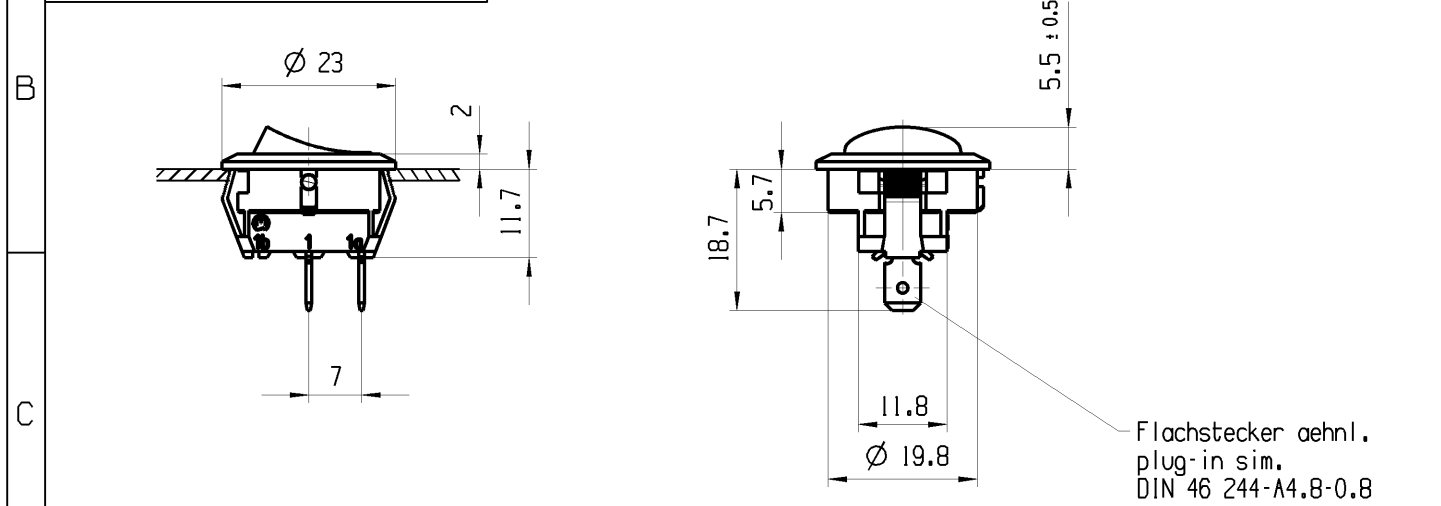

Aufschrift  
Marking

Ⓜ  
18..  
8(18)/250~5E4  
12(14)/250~  
5/70A 250V~  
T100/55  05

Aufschriftbeschreibung  
Marking description

R149 



R149: 15A 125-250V AC  
3/4 HP 125V AC  
1 1/2 HP 250V AC

Ausschalter 1-polig  
Fuer Gerate der Klasse II geeignet  
Wippe und Gehaeuse V0-Material

SPST  
suitable for appliances of class II  
rocker and housing V0-material

G=Konform nach IEC 60335-1:2001 Kap.30  
G=matching IEC 60335-1:2001 clause 30

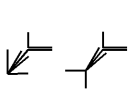
Auf Verpackung/on box: G

fuer Form und Lage FOR SHAPE AND LOC.	⊙ =	Allgemeintoleranzen UNTOLERANCED DIMENSIONS				Pause COPY	Blatt SHEET 01	TYP K	Zeichn./DRAWING NO. 18811108	Index c
fuer Winkel FOR ANGLE ± 2		PROJEKTION 	Abmasse und Nennmassbereiche Angaben in mm	Laenge LENGTH	Radien RADIUS	Original Din A4	Masstab SCALE 1:1 30mm	GERAETESCHALTER		
c	69880	07/26/10	LX	0-6 ± 0.2 ± 0.2	± 0.2	CAD: NX v4.0		appliance switch		
b	54873	10/25/07	LX	>6-15 ± 0.4 ± 0.4	± 0.4	gez./DRAWN BY 02/09/06 RA		 MARQUARDT		
a	45331	02/17/06	MUT	>15-30 ± 0.4 ± 0.4	± 0.4	gepr./CHECKED BY				
	46262	02/14/06	RA	>30-70 ±	± 10%	Ersatz fuer/REPLACEMENT OF V06006120				
Ausg. ISSUE	Aenderung REVISION	gez. DRAWN BY	Ausg. ISSUE	Aenderung REVISION	gez. DRAWN BY					