

Frontplattenausschnitt (Rückseite)
Panel cut out (rear side)

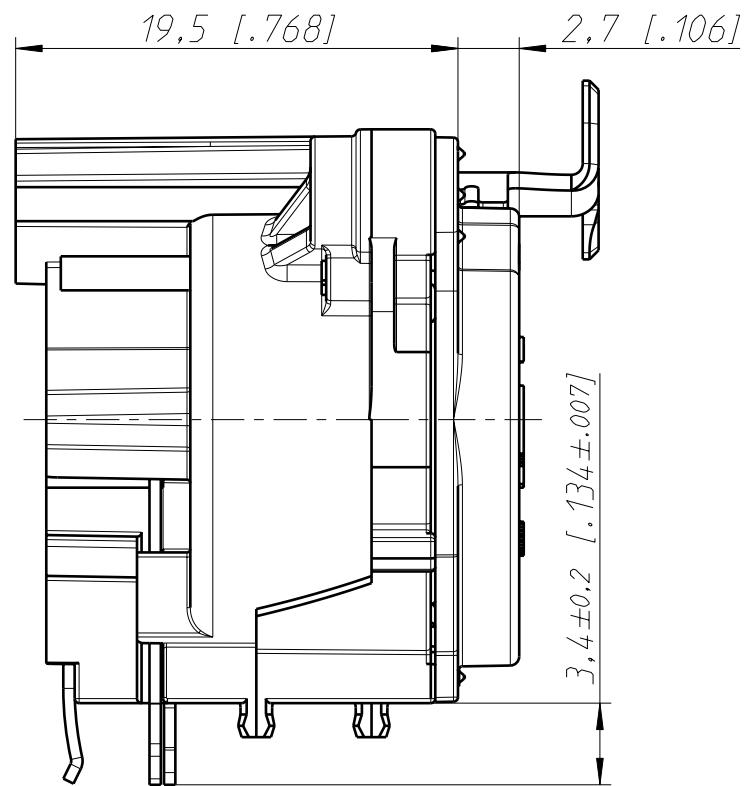

Print-Bohrplan (Bestückungsseite)
PCB-LAYOUT (component side)

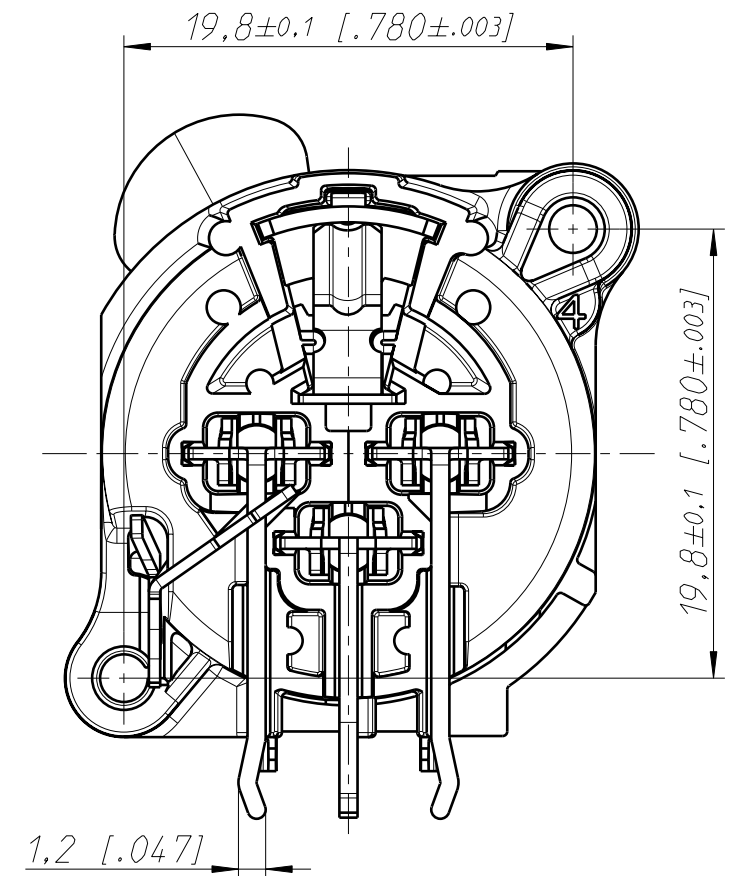

min. Einbauabstand
min assembling distance

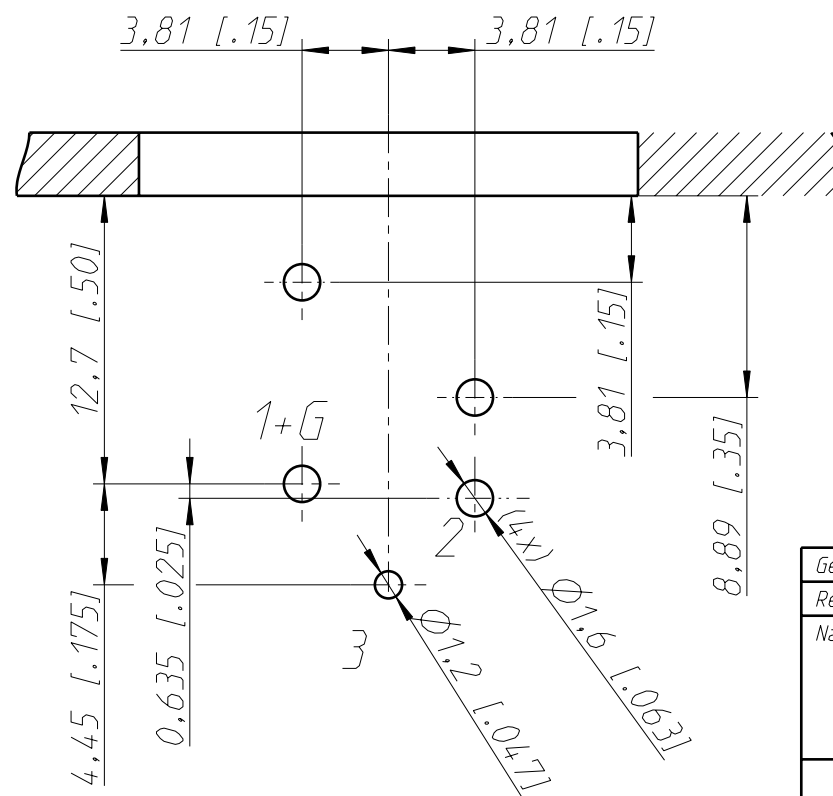
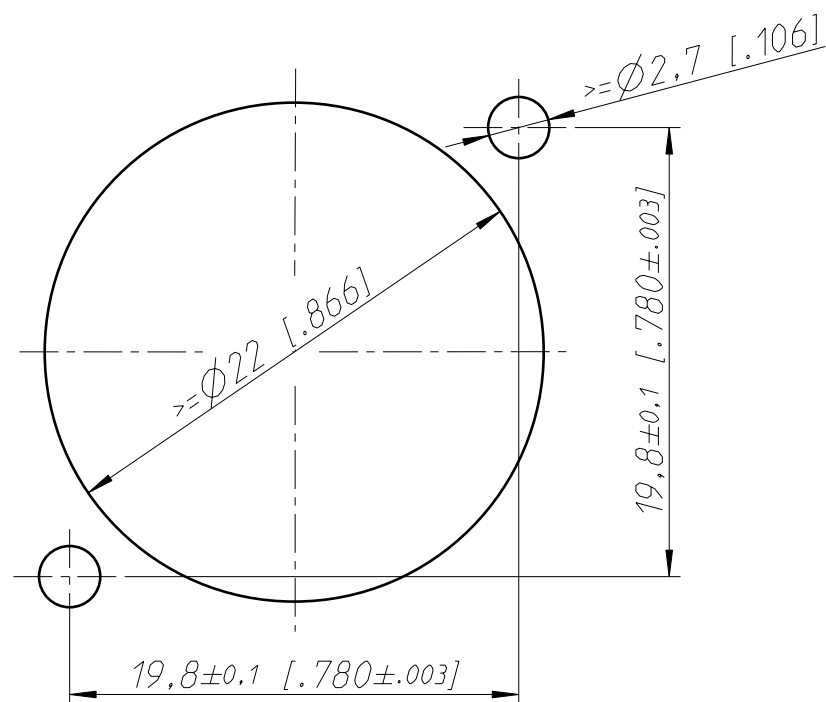

General tolerances ISO 2768-m	Scale	Date	Name
Refer to protection notice ISO 16016.	3:1 (A3)	17.05.17	Karlinger
Name	NC 3FBH	Modified	07.03.19
	NC 3FBH1-DA	Change-No.	Sheet-No.
		2018-0141	1 / 1
		Index	-
Replacement for:		Drawing-No.	
NEUTRIK		ST-NC 3FBH1-DA	