

Data sheet | Item number: 899-631/334-000

Distribution box; Single-phase current (230 V); 1 input; 13 outputs; Cod. A;
MIDI; black

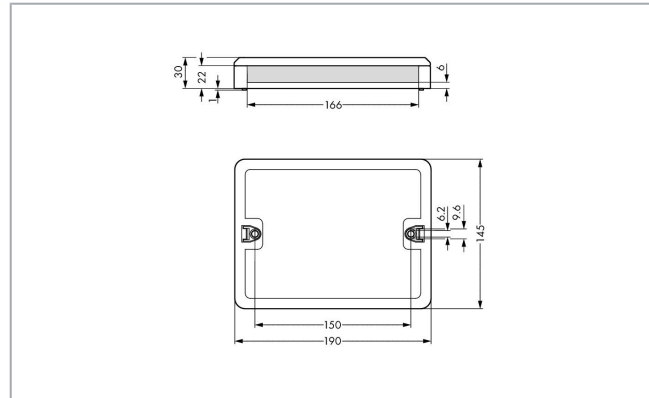

www.wago.com/899-631/334-000

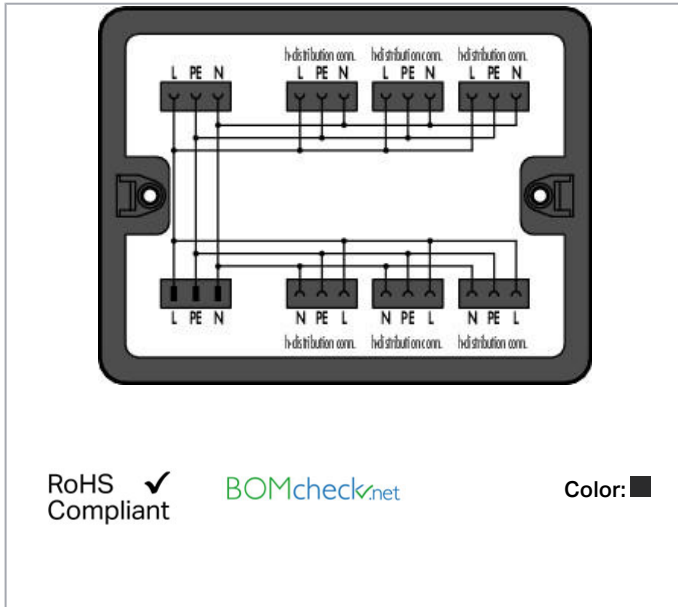

Item description

This WINSTA® Distribution Box duplicates the outputs of a 3-pole, single-phase cable.

Includes: Six 770-634 h-Distribution Connectors

Data

Electrical data

Note on contact resistance

approx. 1 mΩ of contact resistance approx. 0.25 mΩ contact transition plug/socket

Ratings per IEC/EN

Ratings per	IEC/EN 60664-1
Nominal voltage (III/3)	250 V
Rated surge voltage (III/3)	4 kV
Rated current	25 A
Legend (ratings)	(III / 3) ≙ Overvoltage category III / Pollution degree 3

Subject to changes. Please also observe the further product documentation!

WAGO Kontakttechnik GmbH & Co. KG
Hansastr. 27
32423 Minden
Phone: +49571 887-0 | Fax: +49571 887-169
Email: info.de@wago.com | Web: www.wago.com

Do you have any questions about our products?
We are always happy to take your call at +49 (571) 887-44222.



Physical data

Width	190 mm / 7.48 inch
Height	30 mm / 1.181 inch
Depth	145 mm / 5.709 inch

Mechanical data

Internal wiring	4 mm ²
Application	General mains applications
Coding	A
Mounting type	Wall, screw mount Installation on mounting plate
Protection type	IP20
Note on protection type	When mated: IP2xC (These compact connectors are not designed for use in open, easily accessible areas!)

Plug-in connection

Mismating protection	Yes
Note on mismating protection	All WINSTA [®] components are 100% protected against mismating when: a.) plugging different numbers of poles b.) plugging while rotated 180 c.) plugging while laterally staggered d.) plugging one pole
Locking of plug-in connection	locking lever

Material data

Color	black
Insulation material	Polyamide (PA66)
Contact material	Copper or copper alloy (surface-treated)
Fire load	9.68 MJ
Weight	466.5 g

Environmental requirements

Processing temperature	-5 ... +40 °C
Continuous operating temperature	-35 ... +85 °C
Note on continuous operating temperature	Insulating parts for temperatures ≤ 105 °C

Subject to changes. Please also observe the further product documentation!









WAGO Kontakttechnik GmbH & Co. KG
 Hansastr. 27
 32423 Minden
 Phone: +49571 887-0 | Fax: +49571 887-169
 Email: info.de@wago.com | Web: www.wago.com

Do you have any questions about our products?
 We are always happy to take your call at +49 (571) 887-44222.

Commercial data

Packaging type	BOX
Country of origin	DE
GTIN	4055143303279
Customs tariff number	85366990990

Counterpart

	Item no. 770-103 Socket; with strain relief housing; 3-pole; Cod. A; 4,00 mm ² ; black	www.wago.com/770-103
	Item no. 770-113 Plug; with strain relief housing; 3-pole; Cod. A; 4,00 mm ² ; black	www.wago.com/770-113
	Item no. 770-203/035-000 Socket; with strain relief housing; 3-pole; Cod. A; 4,00 mm ² ; black	www.wago.com/770-203/035-000
	Item no. 770-203 Socket; 3-pole; Cod. A; 4,00 mm ² ; black	www.wago.com/770-203
	Item no. 770-213 Plug; 3-pole; Cod. A; 4,00 mm ² ; black	www.wago.com/770-213
	Item no. 770-213/035-000 Plug; with strain relief housing; 3-pole; Cod. A; 4,00 mm ² ; black	www.wago.com/770-213/035-000
	Item no. 771-9993/006-101 pre-assembled interconnecting cable; Eca; Socket/plug; 3-pole; Cod. A; H05VV-F 3G 1.5 mm ² ; 1 m; 1,50 mm ² ; black	www.wago.com/771-9993/006-101
	Item no. 771-9993/206-101 pre-assembled connecting cable; Eca; Plug/open-ended; 3-pole; Cod. A; H05VV-F 3G 1.5 mm ² ; 1 m; 1,50 mm ² ; black	www.wago.com/771-9993/206-101
	Item no. 771-9993/106-101 pre-assembled connecting cable; Eca; Socket/open-ended; 3-pole; Cod. A; H05VV-F 3G 1.5 mm ² ; 1 m; 1,50 mm ² ; black	www.wago.com/771-9993/106-101

Compatible products

assembling

	Item no.: 770-680 Mounting plate; for distribution boxes	www.wago.com/770-680
--	--	--

Subject to changes. Please also observe the further product documentation!

Downloads

Documentation

Bid Text

899-631/334-000 doc - Datei	11. 3. 2015	doc 25.6 kB	Download
899-631/334-000 X81 - Datei	19. 2. 2019	xml 3.5 kB	Download

Environmental Product Compliance

Compliance Search

Environmental Product Compliance 899-631/334-000 Distribution box; Single-phase current (230 V); 1 input; 13 outputs; Cod. A; MIDI; black	URL	Download
--	-----	----------

Installation Notes

Installation



Securing the mounting plate with WINSTA®
Distribution Box to the wall (e.g., via stud gun).

Product family

<i>WINSTA</i>® Boxen

WINSTA® ist das Steckverbindersystem, das optimal auf die hohen Anforderungen in der Gebäudeinstallation zugeschnitten ist. Es macht die Elektroinstallation steckbar und dadurch schnell, sicher und fehlerfrei. Dies gilt auch in weiteren Anwendungen wie z. B. im Schiffbau, in der Bahntechnik oder in der Industrie.

[Show all products from the family](#)

Subject to changes. Please also observe the further product documentation!