

2JL30

2.4 GHz ISM Surface Mount

Key Features

2.4 GHz ISM

- 2410-2490 MHz

Surface Mount

Easy to Integrate

Compact Size

Ceramic Material

Ground Plane Dependent

Dimensions 3.2 x 1.6 x 0.5 mm

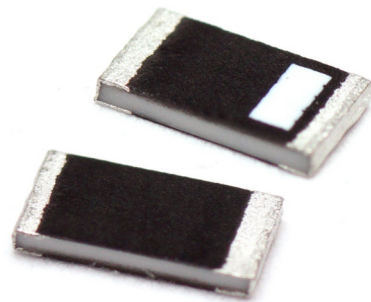

1. Antenna and electrical specifications

Parameters	2.4 GHz ISM Antenna
Standards	WiFi, BT, ZigBee, ISM,
Band (MHz)	2400
Frequency (MHz)	2410-2490
Return Loss (dB)	~-21.5
VSWR	~1.3:1
Efficiency (%)	~63.3
Peak Gain (dBi)	~1.1
Average Gain (dB)	~-2.0
Impedance (Ohm)	50
Polarisation	Linear
Radiation Pattern	Omni-Directional
Max. Input Power (W)	25

Antenna Measurement Conditions:

Mounted on ground plane of 80 x 40 mm

Measured in Certified CTIA 3D Anechoic Chamber

2. Mechanical and environmental specifications

Specifications	2JL30
Mounting Type	Surface Mount
Dimensions (mm)	3.2 x 1.6 x 0.5
Material	Ceramic
Operating Temperature (C)	-40 to +85
Storage Temperature (C)	-40 to +85
Substance Compliance	RoHS

3. Antenna parameters

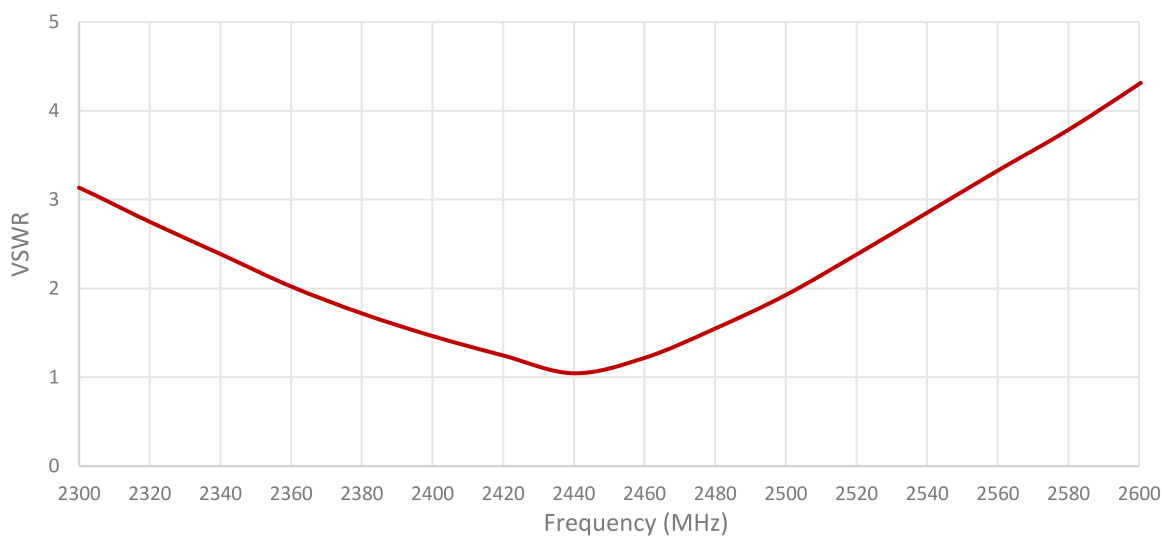
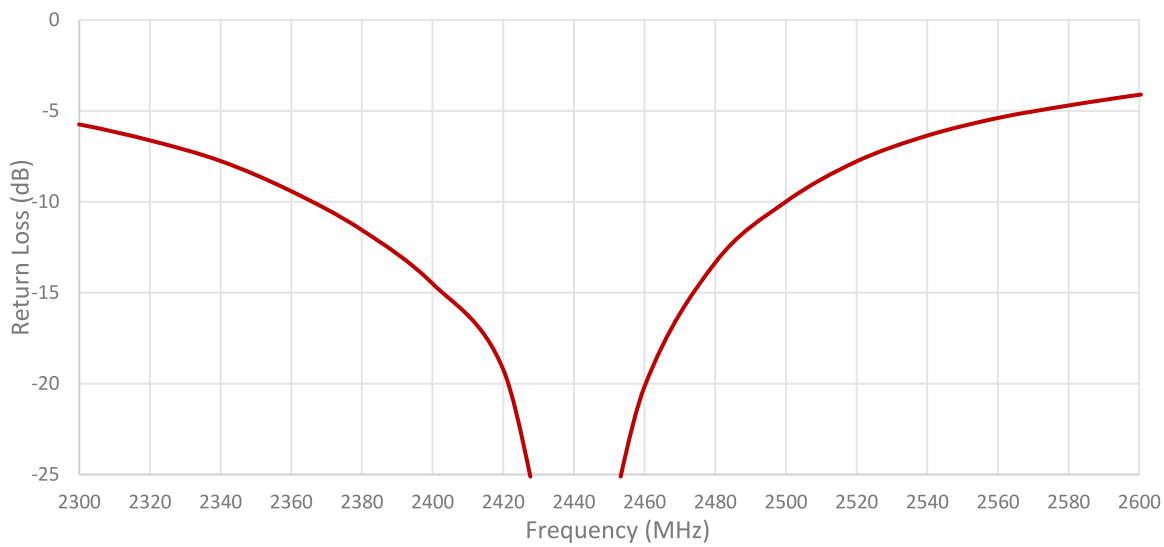

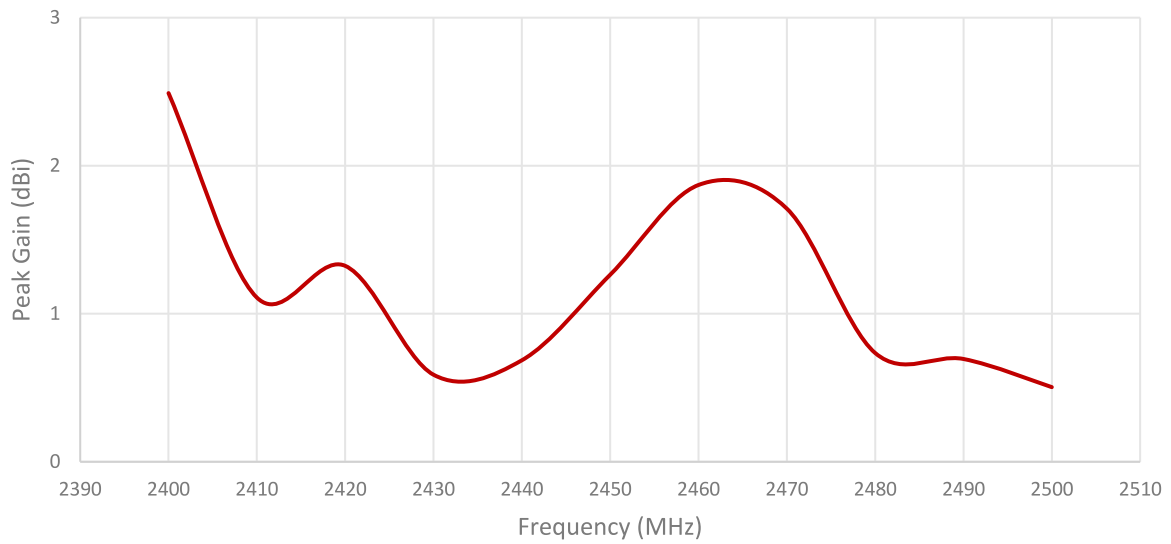
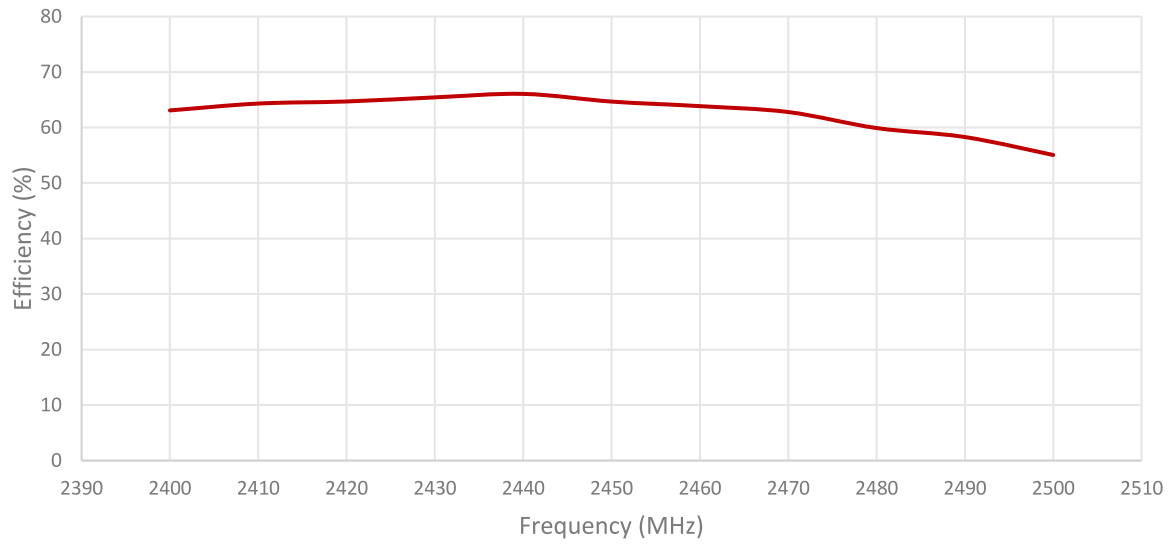

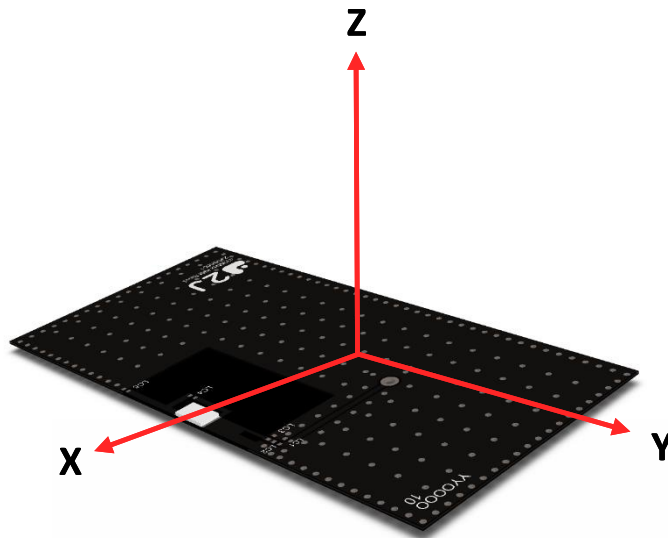
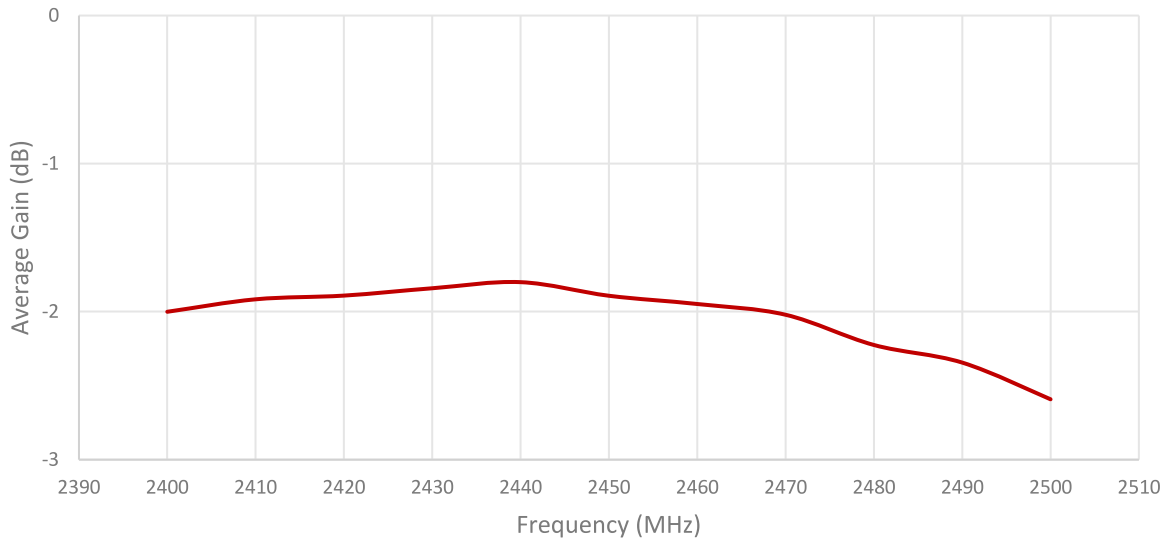

Radiation pattern reference

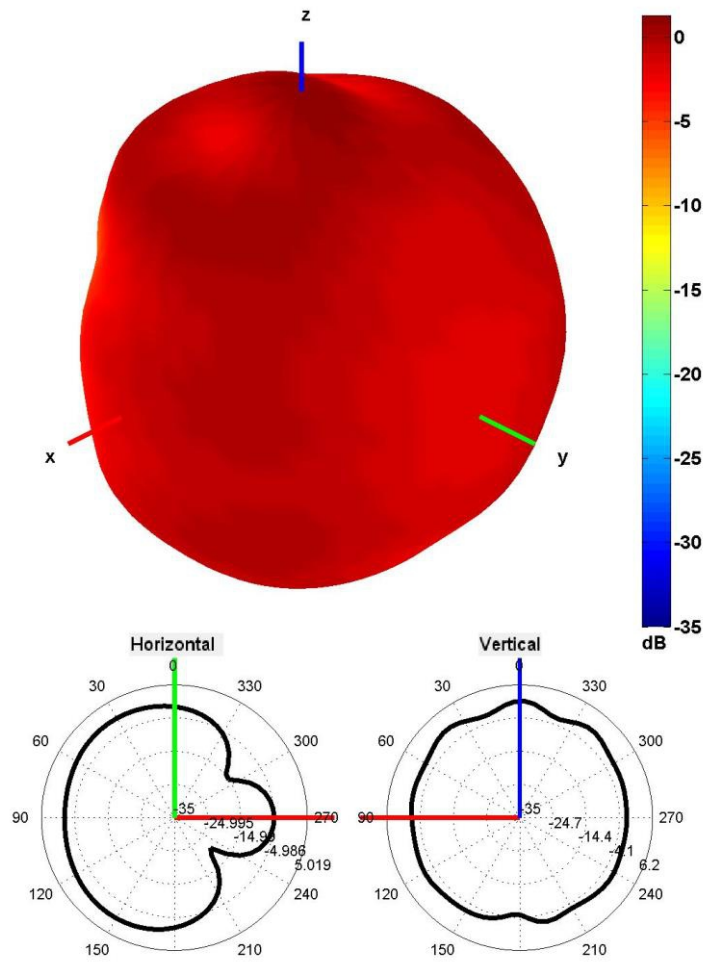

2450 MHz Radiation pattern

4. PCB Layout

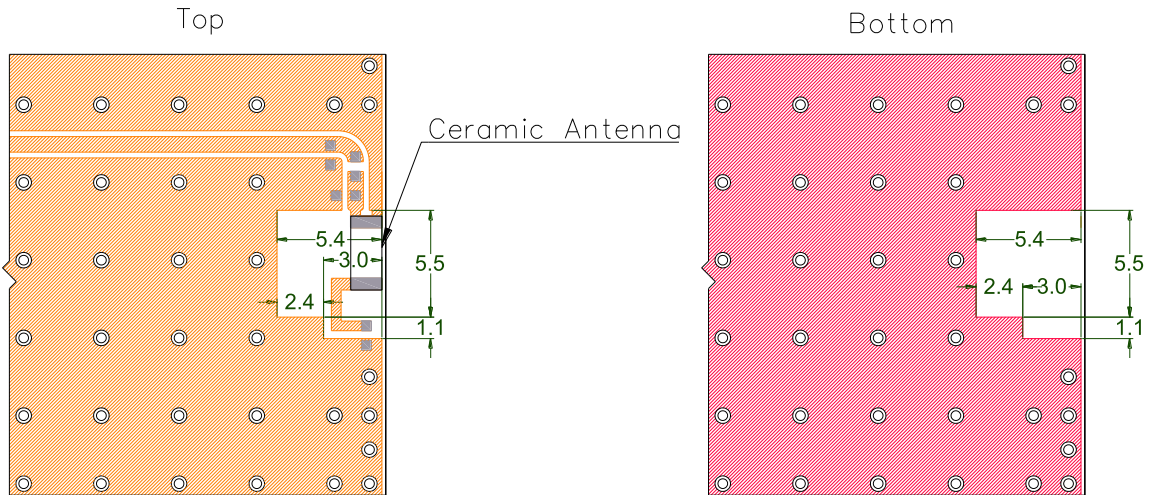

 Solder Region

 Top Copper Region

 Bottom Copper Region

 Copper-Free Region

Minimum area required for antenna integration (10mm × 10mm)

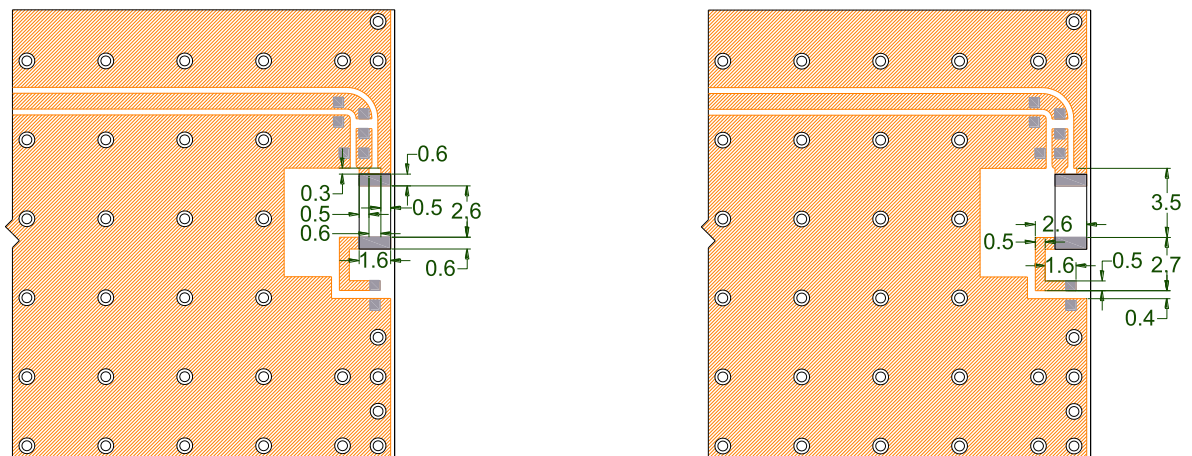

 Solder Region

 Top Copper Region

 Copper-Free Region

Layout dimensions for antenna integration (mm)

5. Matching Components

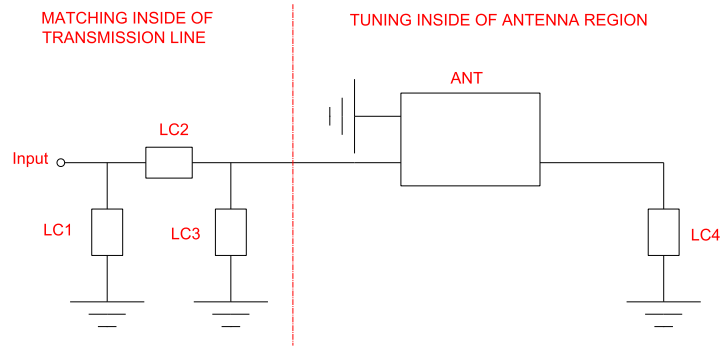

Matching Network Schematic

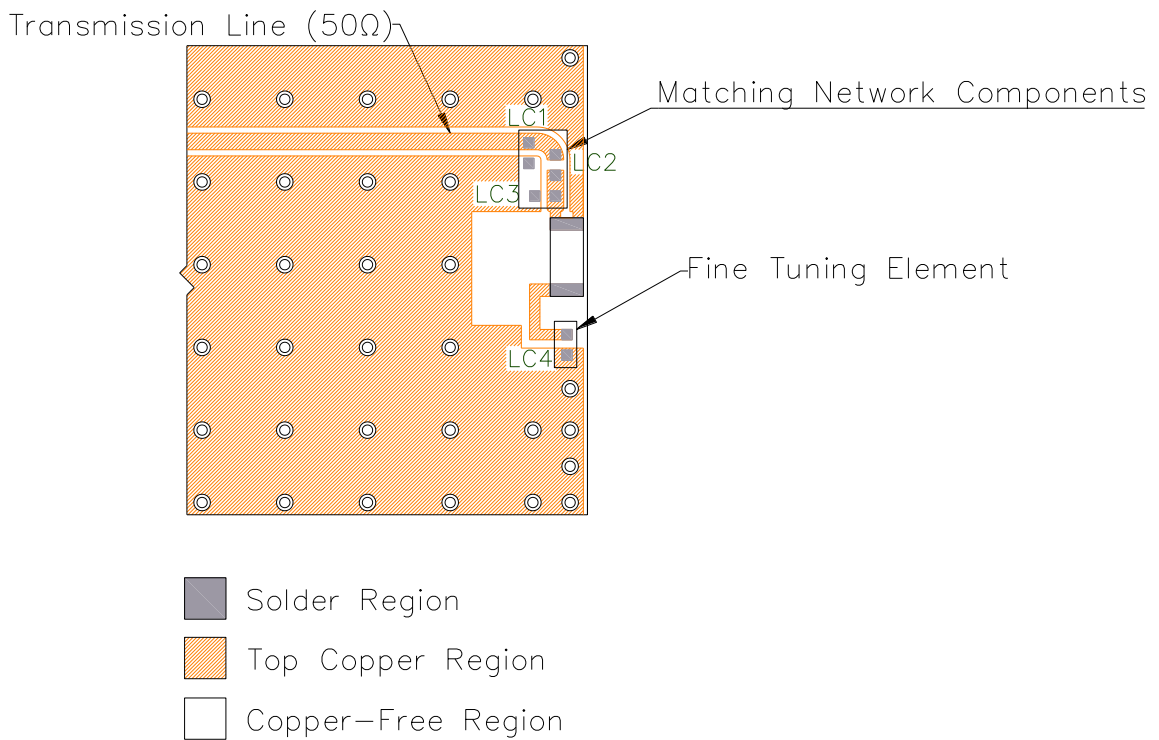

Matching network drawing (LC1=0.2pF±0.05pF, LC2=5.6nH±0.1nH, LC3=OPEN, LC4=0.8pF±0.05pF)

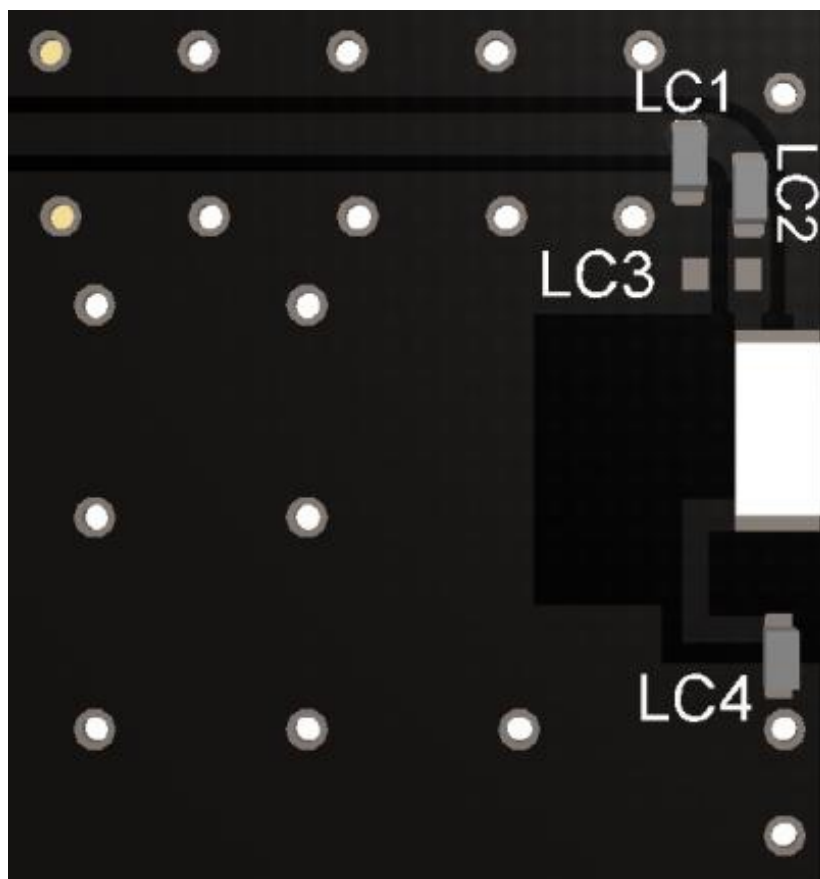

3D View of matching components and recommended values

Matching network drawing (LC1=0.2pF±0.05pF, LC2=5.6nH±0.1nH, LC3=OPEN, LC4=0.8pF±0.05pF)

REFLOW TEMPERATURE PROFILE

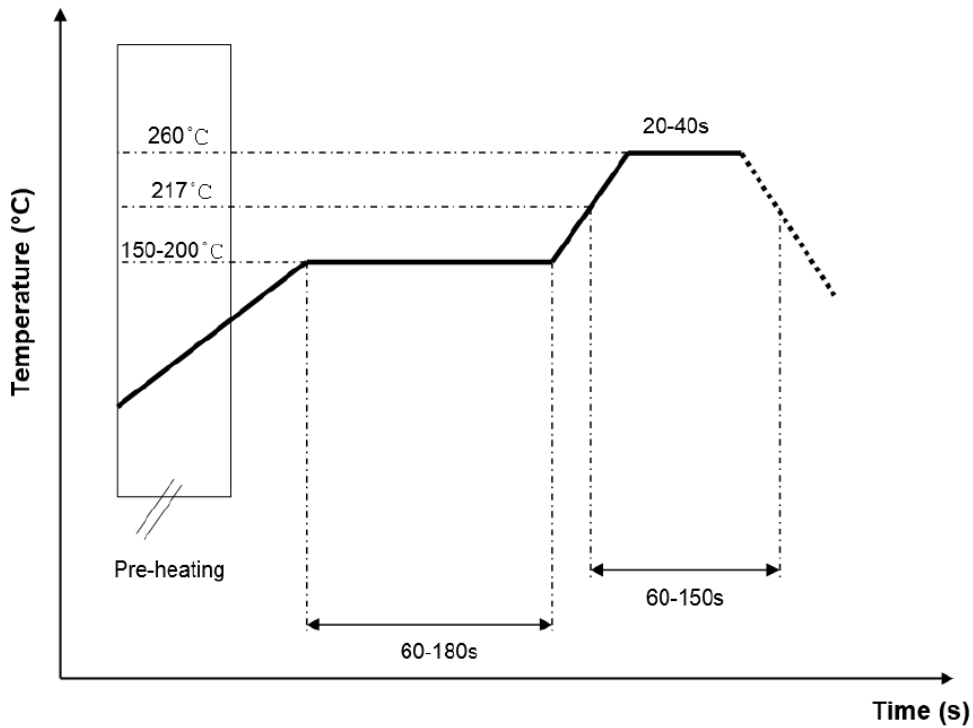

6. Evaluation Board

80mm x 40mm

80mm x 40mm

80mm x 40mm

80mm x 10.8mm
(PCB: 0.8mm, Antenna: 0.5mm,
Connector: 9.5mm)

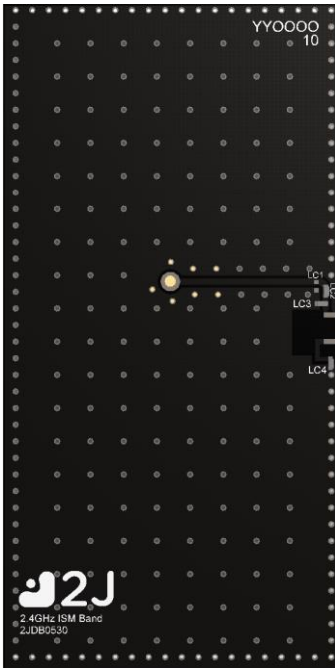

Front View without Antenna

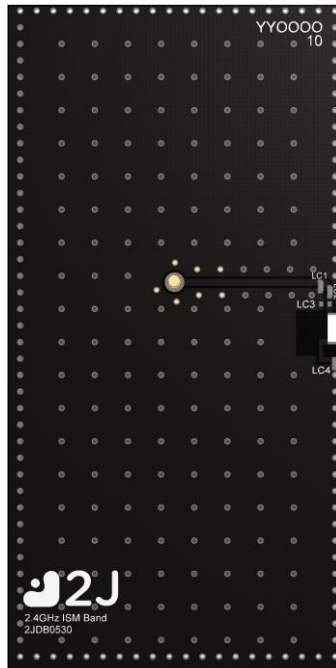

Front View with Antenna

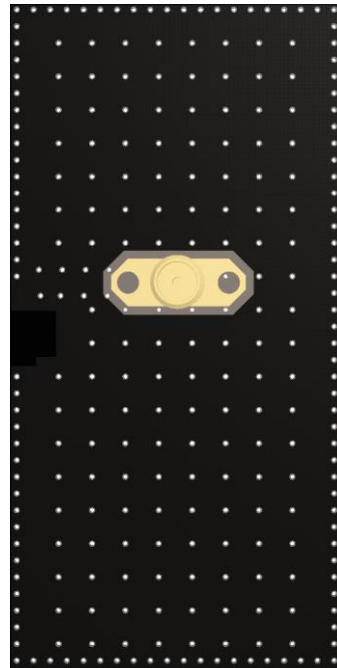

Back View

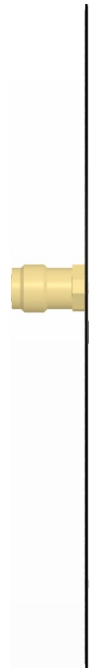

Side View

7. Antenna drawings

Bottom

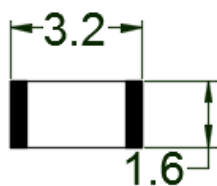

Top



Feed Point

Front



Right

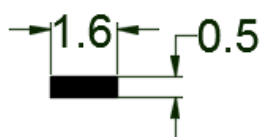

Dimensions for ceramic antenna 3.2 x 1.6 x 0.5 mm

8. Tape and Reel Information

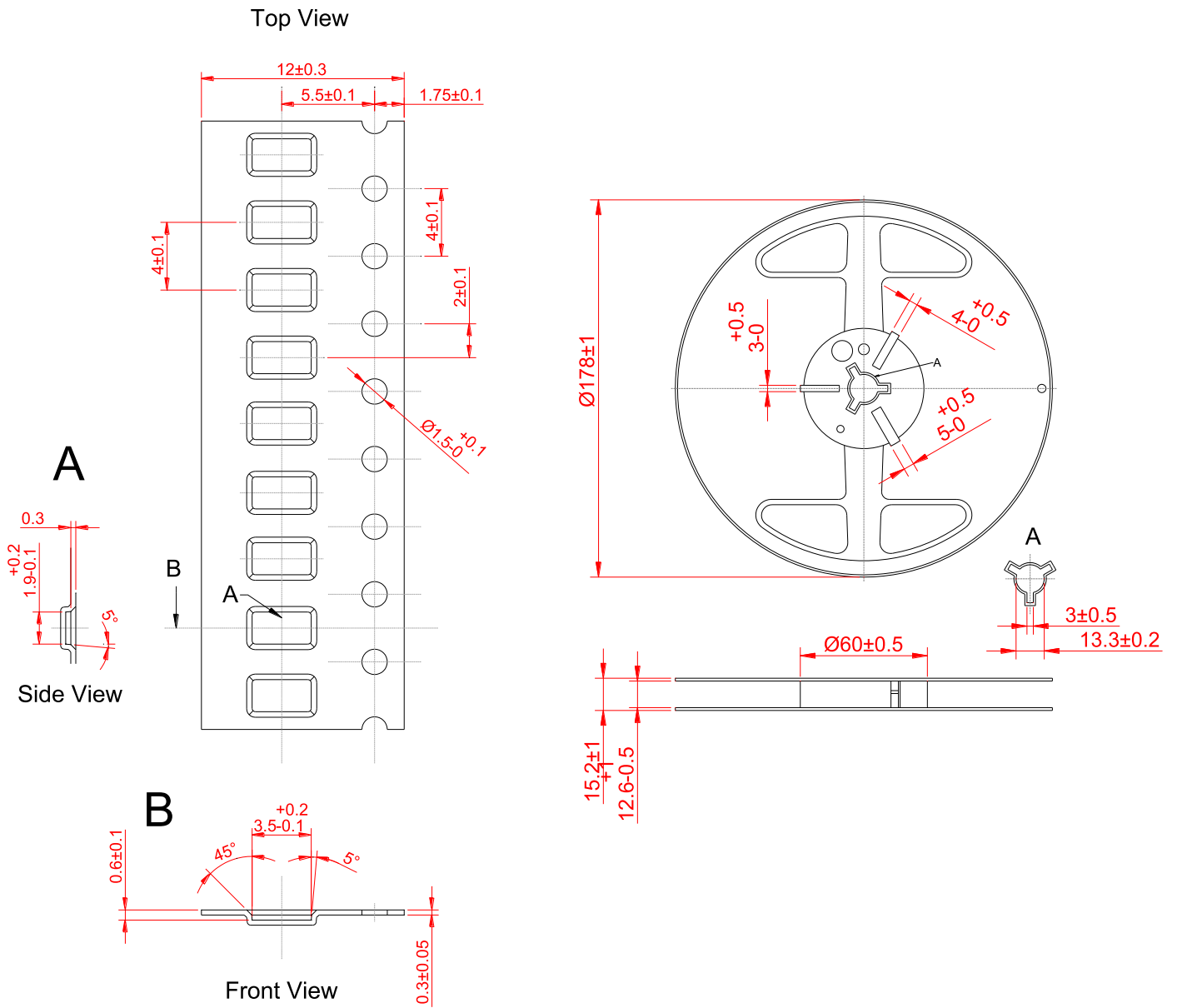

Tape and Reel Specifications

9. Packaging

PACKAGING SPECIFICATION

Antenna	2JL30
REEL	
Max Quantity per Reel	6000
REEL BOX	
Reels per Box	2
Max Quantity per Box	12000
Reel Box Dimensions (cm)	18 x 18 x 3.6
Reel Box Weight (Kg)	0.7
CARTON	
Reels per Carton	2
Max Quantity per Carton	120000
Reel Carton Dimensions (cm)	40.5 x 24.7 x 22.5
Reel Carton Weight (Kg)	7

Storage Conditions:

- Storage Temperature Range: -40 °C to +85 °C
- Oxidizable material. Store for 12 months in vacuum sealed bag.
- Repack material after use by re-sealing package.

10. Antenna Images

