

LPC 6/ 6-ST-7,62 - PCB connector



1716926

<https://www.phoenixcontact.com/sk/products/1716926>

Please be informed that the data shown in this PDF document is generated from our online catalog. Please find the complete data in the user documentation. Our general terms of use for downloads are valid.

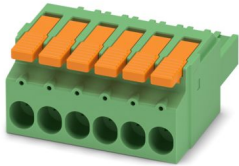

PCB connector, nominal cross section: 6 mm², color: green, nominal current: 41 A, rated voltage (III/2): 1000 V, contact surface: Sn, contact connection type: Socket, number of potentials: 6, number of rows: 1, number of positions: 6, number of connections: 6, product range: LPC 6/..-ST, pitch: 7.62 mm, connection method: Lever Push-in connection, conductor/PCB connection direction: 0 °, locking clip: - without locking clip, plug-in system: COMBICON PC 6, locking: without, mounting: without, type of packaging: packed in cardboard

Your advantages

- Tool-free lever principle enables time-saving connection and release of conductors with/without ferrules
- Clear lever positions provide reliable feedback on opened or closed clamping spaces
- Defined contact force ensures that contact remains stable over the long term
- Time-saving push-in connection when lever is closed
- Increased touch protection in accordance with IEC/UL 61800-5-1

Commercial data

Item number	1716926
Packing unit	25 pc
Minimum order quantity	25 pc
Note	Made to order (non-returnable)
Sales key	AAD
Product key	AADBAA
GTIN	4055626514918
Weight per piece (including packing)	42.944 g
Weight per piece (excluding packing)	22.22 g
Customs tariff number	85366990
Country of origin	PL

LPC 6/ 6-ST-7,62 - PCB connector



1716926

<https://www.phoenixcontact.com/sk/products/1716926>

Technical data

Product properties

Product type	PCB connector
Product family	LPC 6/...-ST
Product line	COMBICON Connectors L
Number of positions	6
Pitch	7.62 mm
Number of connections	6
Number of rows	1
Number of potentials	6

Data management status

Article revision	04
------------------	----

Electrical properties

Nominal current I_N	41 A
Nominal voltage U_N	1000 V
Contact resistance	0.5 m Ω
Rated voltage (III/3)	800 V
Rated surge voltage (III/3)	8 kV
Rated voltage (III/2)	1000 V
Rated surge voltage (III/2)	8 kV
Rated voltage (II/2)	1000 V
Rated surge voltage (II/2)	6 kV

Connection data

Connection technology

Connector system	COMBICON PC 6
Nominal cross section	6 mm ²
Contact connection type	Socket

Interlock

Locking type	without
Mounting flange	without

Conductor connection

Connection method	Lever Push-in connection
Connection direction of the conductor to plug-in direction	0 °
Conductor/PCB connection direction	0 °
Conductor cross section rigid	0.75 mm ² ... 10 mm ²
Conductor cross section flexible	0.75 mm ² ... 6 mm ²
Conductor cross section AWG	18 ... 8
Conductor cross section flexible, with ferrule without plastic sleeve	0.75 mm ² ... 6 mm ²

LPC 6/ 6-ST-7,62 - PCB connector

1716926

<https://www.phoenixcontact.com/sk/products/1716926>

Conductor cross section, flexible, with ferrule, with plastic sleeve	0.75 mm ² ... 6 mm ²
Cylindrical gauge a x b / diameter	4.3 mm x 4.0 mm / 4.0 mm
Stripping length	18 mm

Material specifications

Material data - contact

Note	WEEE/RoHS-compliant, free of whiskers according to IEC 60068-2-82/JEDEC JESD 201
Contact material	Cu alloy
Surface characteristics	Tin-plated
Metal surface terminal point (top layer)	Tin (4 - 8 µm Sn)
Metal surface contact area (top layer)	Tin (4 - 8 µm Sn)

Material data - housing

Color (Housing)	green (6021)
Insulating material	PA GF
Insulating material group	I
CTI according to IEC 60112	600
Flammability rating according to UL 94	V0

Material data – actuating element

Color (Actuating element)	orange (2003)
Insulating material	PA GF
Insulating material group	I
CTI according to IEC 60112	600
Flammability rating according to UL 94	V0

Dimensions

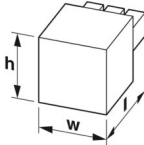
Dimensional drawing	
Pitch	7.62 mm
Width [w]	47.72 mm
Height [h]	35.65 mm
Length [l]	48 mm

Notes

Notes on operation	In accordance with IEC 61984, COMBICON connectors have no switching power (COC). During designated use, they must not be plugged in or disconnected when carrying voltage or under load.
--------------------	--

Mechanical tests

Conductor connection

LPC 6/ 6-ST-7,62 - PCB connector



1716926

<https://www.phoenixcontact.com/sk/products/1716926>

Specification	IEC 60999-1:1999-11
Result	Test passed

Test for conductor damage and slackening

Specification	IEC 60999-1:1999-11
Result	Test passed

Repeated connection and disconnection

Specification	IEC 60999-1:1999-11
Result	Test passed

Pull-out test

Specification	IEC 60999-1:1999-11
Conductor cross section/conductor type/tractive force setpoint/actual value	0.75 mm ² / solid / > 30 N
	0.75 mm ² / flexible / > 30 N
	10 mm ² / solid / > 90 N
	6 mm ² / flexible / > 80 N

Insertion and withdrawal forces

Specification	IEC 60512-13-2:2006-02
Result	Test passed
No. of cycles	25
Insertion strength per pos. approx.	11 N
Withdraw strength per pos. approx.	10 N

Resistance of inscriptions

Specification	IEC 60068-2-70:1995-12
Result	Test passed

Polarization and coding

Specification	IEC 60512-13-5:2006-02
Result	Test passed

Visual inspection

Specification	IEC 60512-1-1:2002-02
Result	Test passed

Dimension check

Specification	IEC 60512-1-2:2002-02
Result	Test passed

Environmental and real-life conditions

Vibration test

Specification	IEC 60068-2-6:2007-12
Frequency	10 - 150 - 10 Hz
Sweep speed	1 octave/min
Amplitude	0.35 mm (10 Hz ... 60.1 Hz)

LPC 6/ 6-ST-7,62 - PCB connector



1716926

<https://www.phoenixcontact.com/sk/products/1716926>

Acceleration	5g (60.1 Hz ... 150 Hz)
Test duration per axis	2.5 h
Test directions	X-, Y- and Z-axis

Durability test

Specification	IEC 60512-9-1:2010-03
Impulse withstand voltage at sea level	7.3 kV
Contact resistance R ₁	0.5 mΩ
Contact resistance R ₂	0.5 mΩ
Insertion/withdrawal cycles	25
Insulation resistance, neighboring positions	> 5 MΩ

Climatic test

Specification	ISO 6988:1985-02
Corrosive stress	0.2 dm ³ SO ₂ on 300 dm ³ /40 °C/1 cycle
Thermal stress	100 °C/168 h
Power-frequency withstand voltage	3.31 kV

Ambient conditions

Ambient temperature (operation)	-40 °C ... 105 °C (dependent on the derating curve)
Ambient temperature (storage/transport)	-40 °C ... 70 °C
Relative humidity (storage/transport)	30 % ... 70 %
Ambient temperature (assembly)	-5 °C ... 100 °C

Electrical tests

Thermal test | Test group C

Specification	IEC 60512-5-1:2002-02
Tested number of positions	6

Insulation resistance

Specification	IEC 60512-3-1:2002-02
Insulation resistance, neighboring positions	> 5 MΩ

Temperature cycles

Specification	IEC 60999-1:1999-11
Result	Test passed

Air clearances and creepage distances |

Specification	IEC 60664-1:2007-04
Insulating material group	I
Comparative tracking index (IEC 60112)	CTI 600
Rated insulation voltage (III/3)	800 V
Rated surge voltage (III/3)	8 kV
minimum clearance value - non-homogenous field (III/3)	8 mm
minimum creepage distance (III/3)	10 mm
Rated insulation voltage (III/2)	1000 V

LPC 6/ 6-ST-7,62 - PCB connector



1716926

<https://www.phoenixcontact.com/sk/products/1716926>

Rated surge voltage (III/2)	8 kV
minimum clearance value - non-homogenous field (III/2)	8 mm
minimum creepage distance (III/2)	8 mm
Rated insulation voltage (II/2)	1000 V
Rated surge voltage (II/2)	6 kV
minimum clearance value - non-homogenous field (II/2)	5.5 mm
minimum creepage distance (II/2)	5.5 mm

Packaging specifications

Type of packaging	packed in cardboard
-------------------	---------------------

Drawings

Diagram

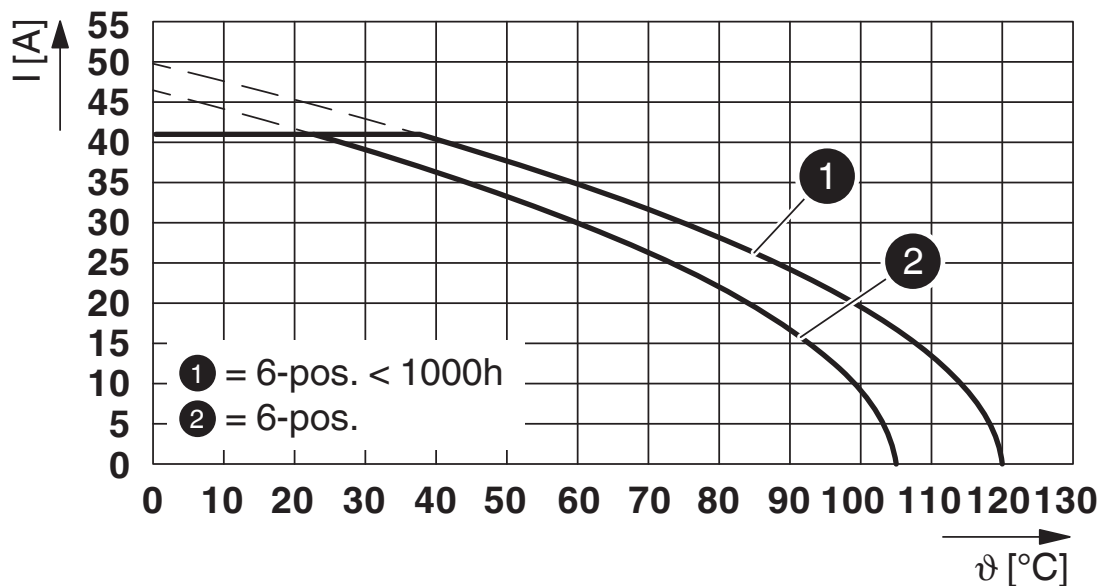

Type: LPC 6/...-ST-7,62 with PCV 6/...-G-7,62 P...THR

Diagram

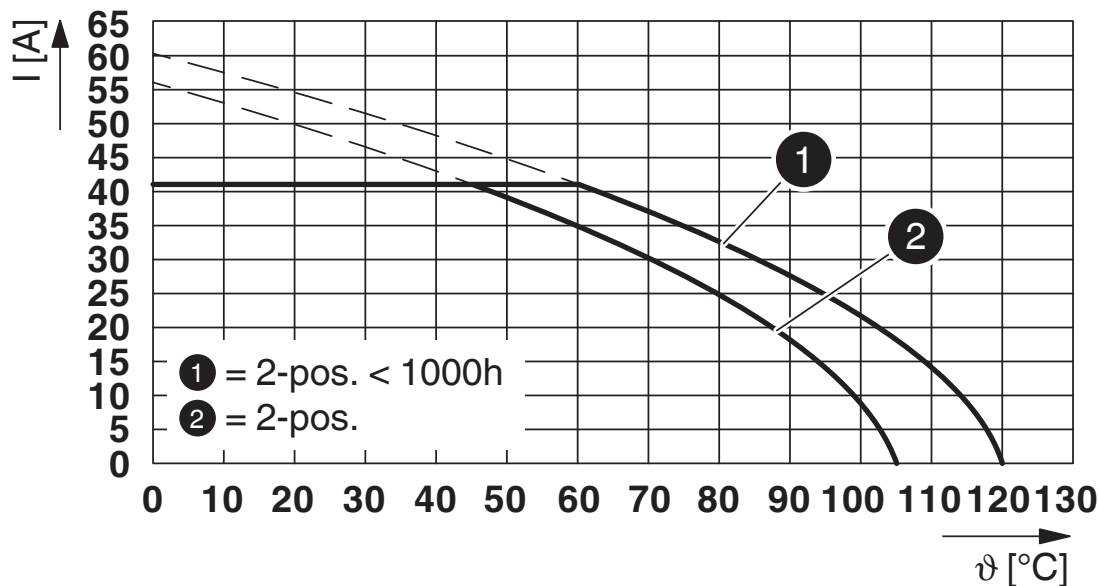

Type: LPC 6/...-ST-7,62 with PC 6/...-GU-7,62 P...THR

LPC 6/ 6-ST-7,62 - PCB connector



1716926

<https://www.phoenixcontact.com/sk/products/1716926>

Diagram

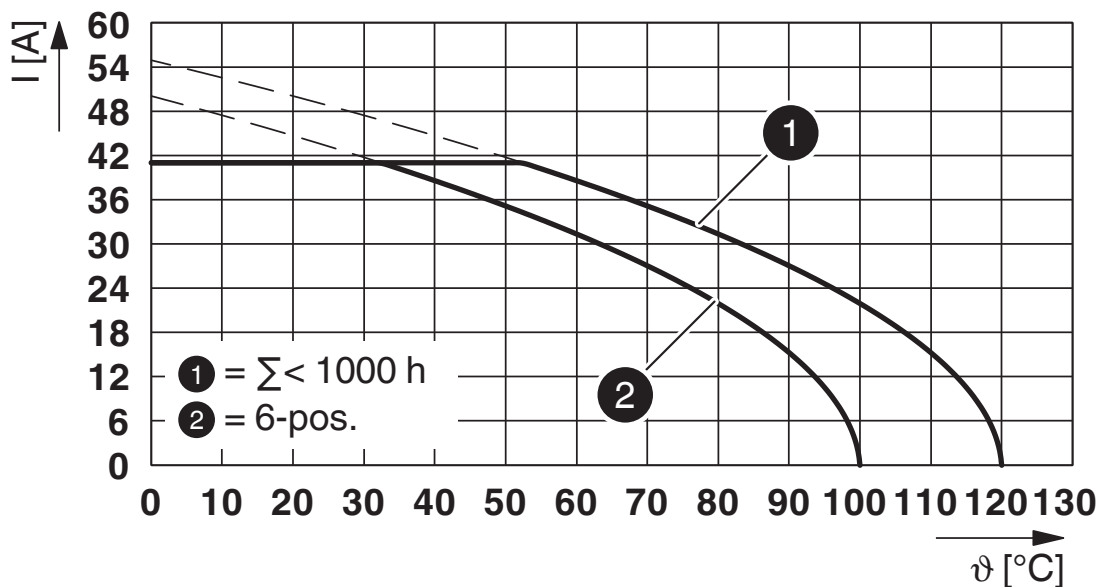

Type: LPC 6/...-ST-7,62 with PC 6/...-G-7,62

Diagram

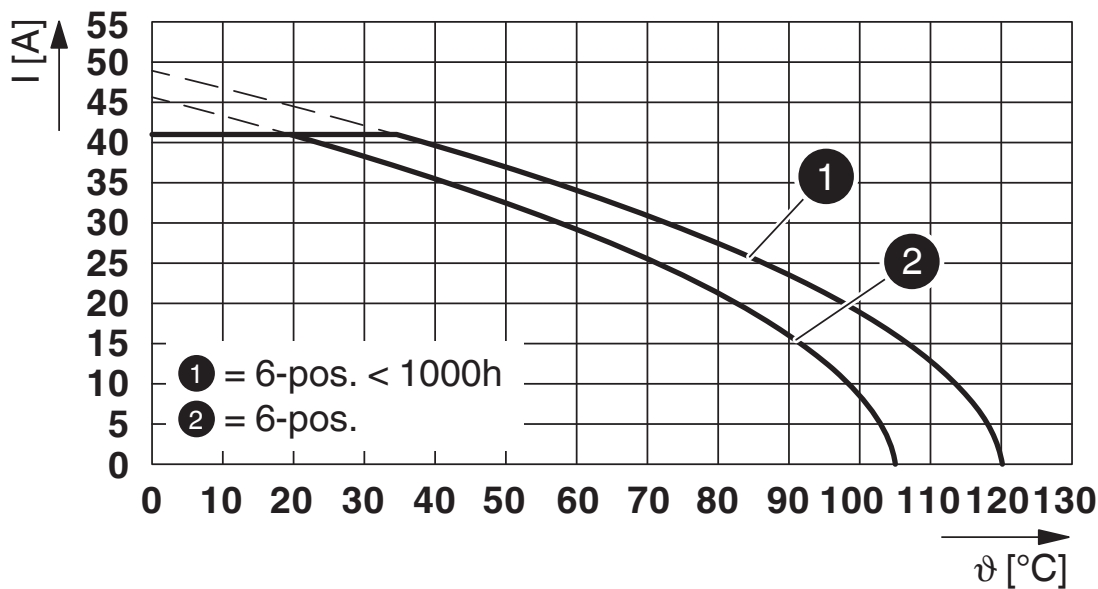

Type: LPC 6/...-ST-7,62 with PC 6/...-G-7,62 P...THR

LPC 6/ 6-ST-7,62 - PCB connector



1716926

<https://www.phoenixcontact.com/sk/products/1716926>

Diagram

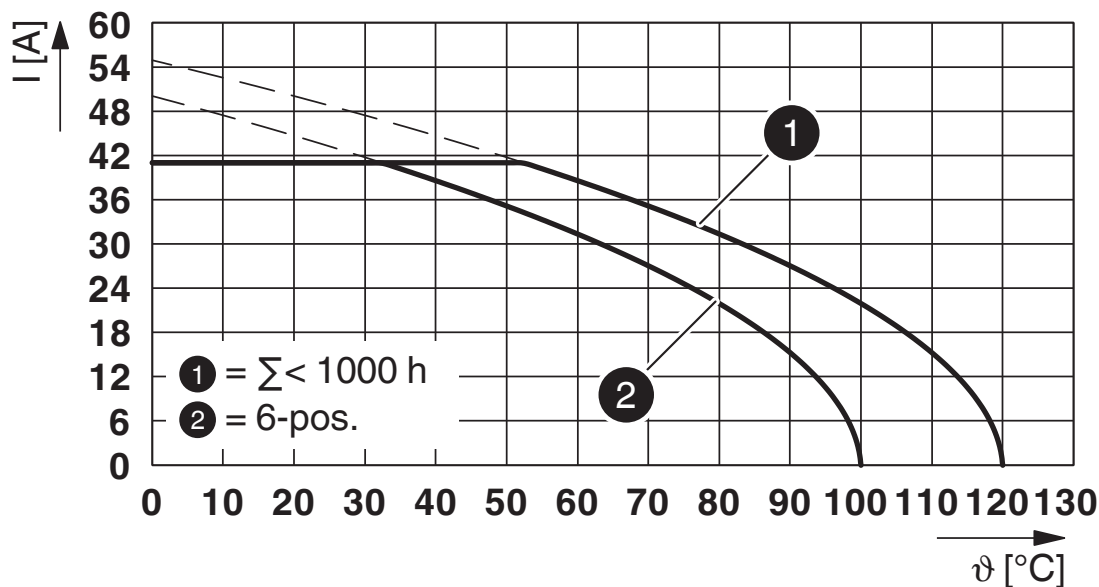

Type: LPC 6/...-ST-7,62 with PC 6/...-GU-7,62

Diagram

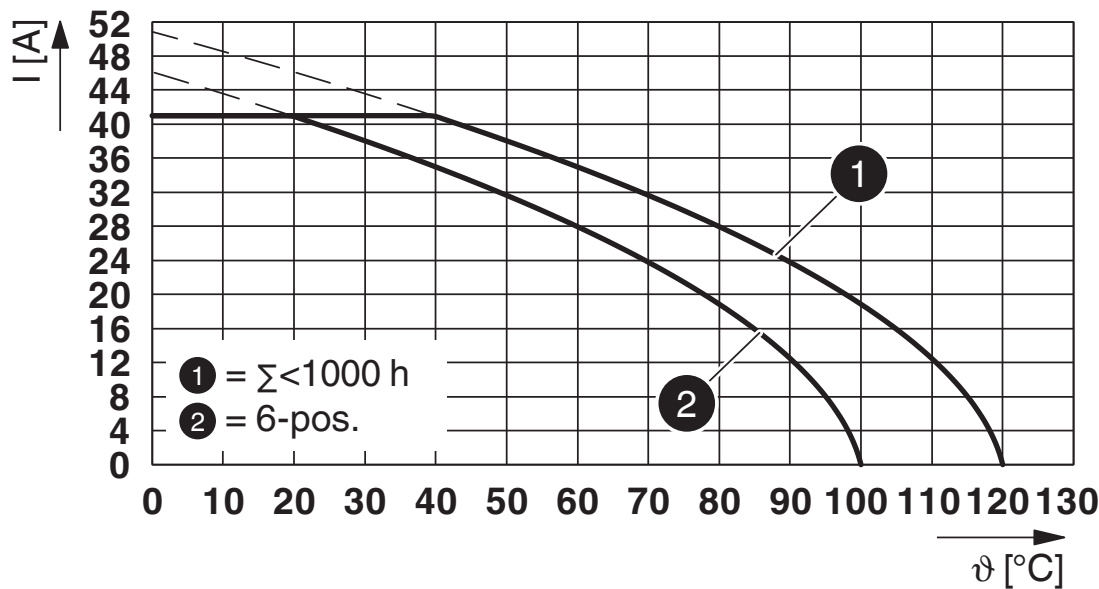

Type: LPC 6/...-ST-7,62 with PCV 6/...-G-7,62

LPC 6/ 6-ST-7,62 - PCB connector



1716926

<https://www.phoenixcontact.com/sk/products/1716926>

Diagram

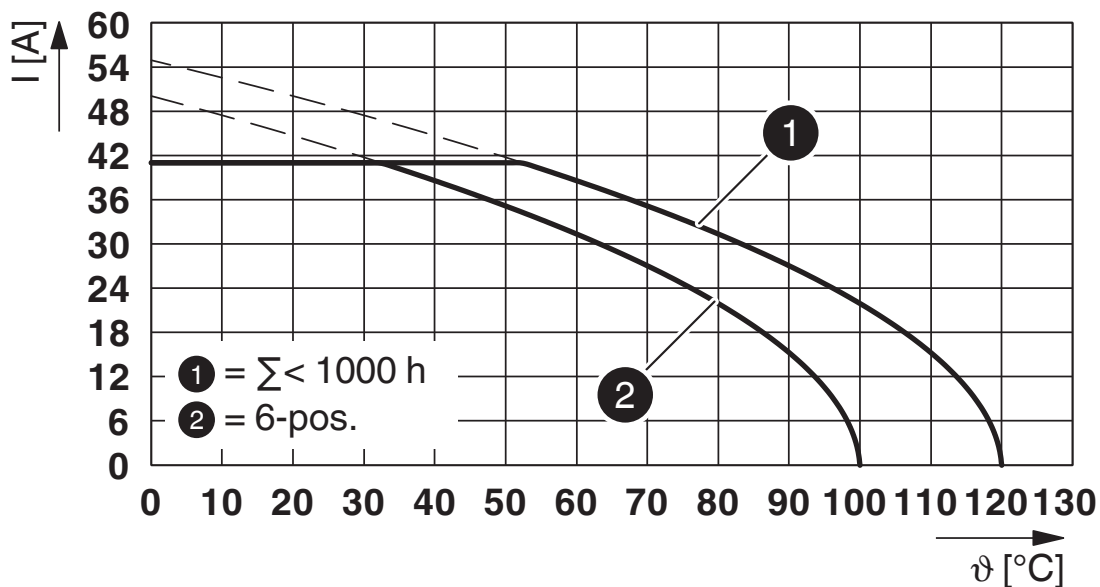

Type: LPC 6/...-ST-7,62 with PC 6/...-G1U-7,62

Diagram

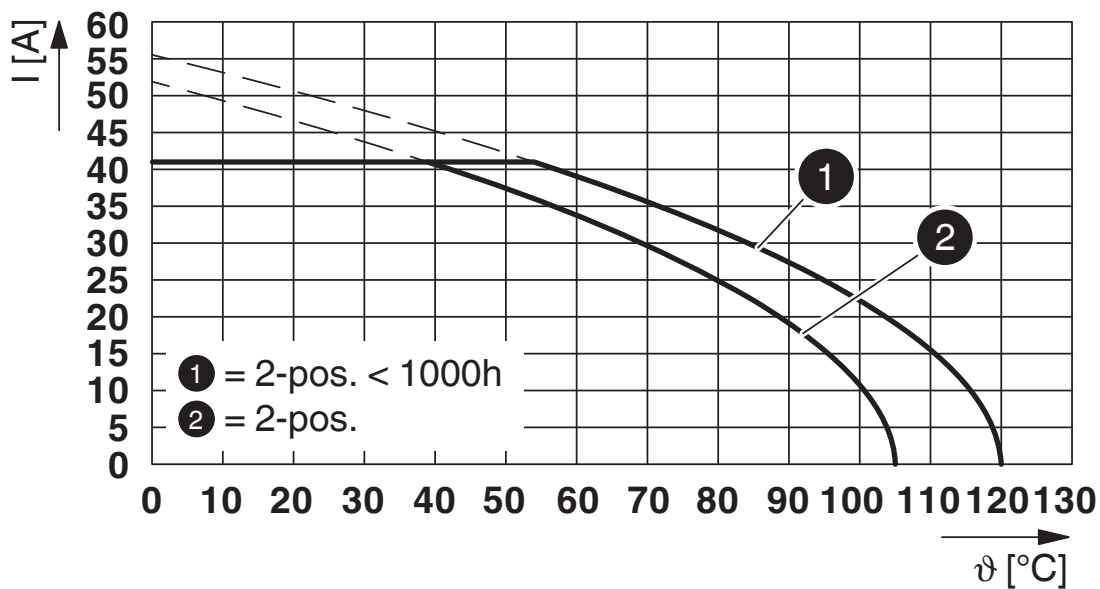

Type: LPC 6/...-ST-7,62 with PCV 6/...-G-7,62 P...THR

LPC 6/ 6-ST-7,62 - PCB connector



1716926

<https://www.phoenixcontact.com/sk/products/1716926>

Diagram

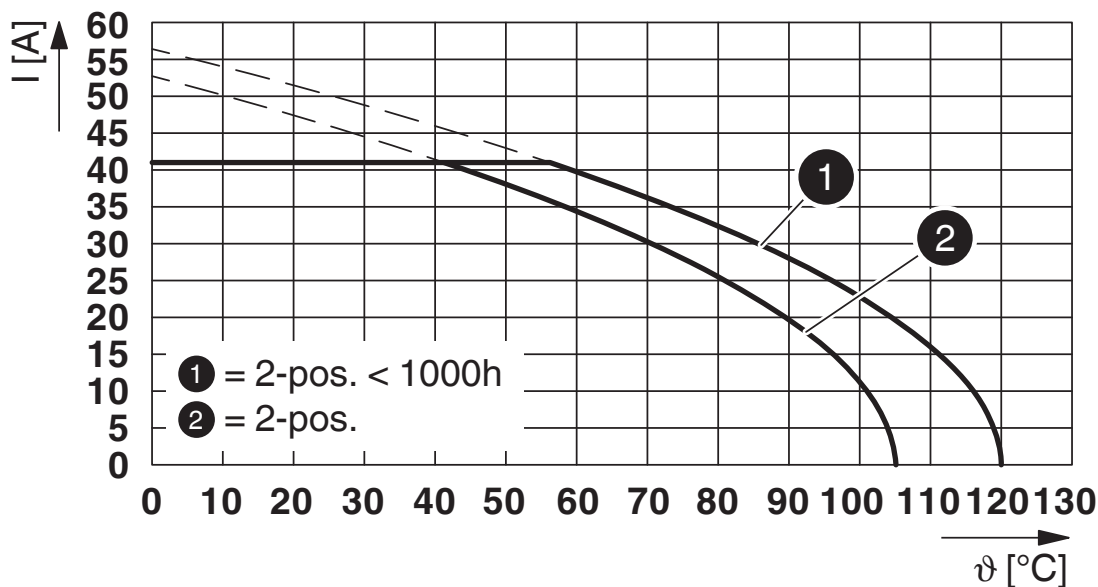

Type: LPC 6/...-ST-7,62 with PC 6/...-G-7,62 P...THR

Diagram

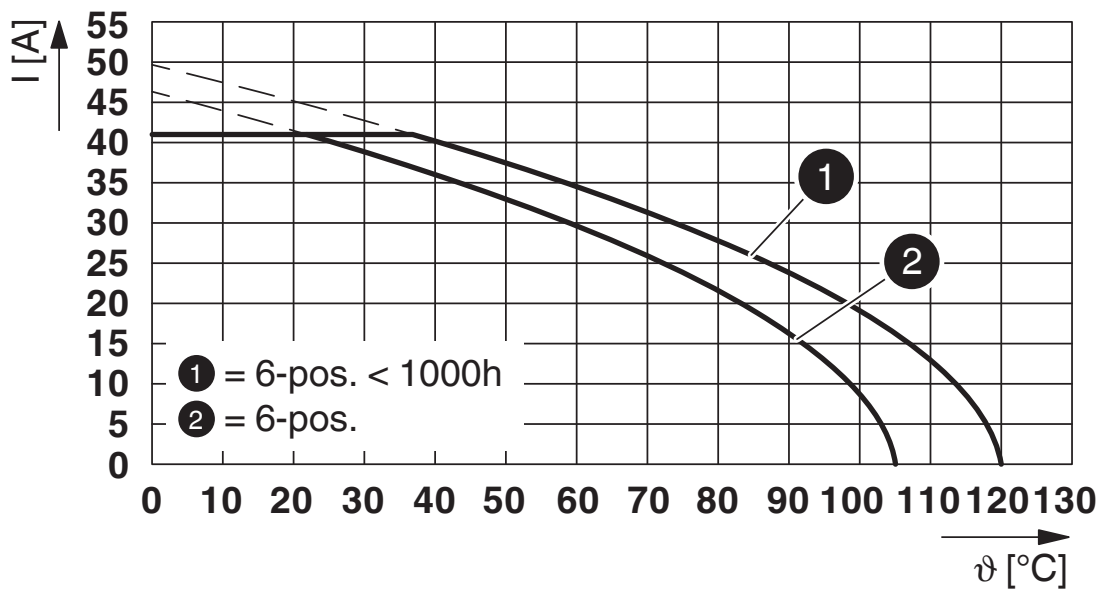

Type: LPC 6/...-ST-7,62 with PC 6/...-GU-7,62 P...THR

LPC 6/ 6-ST-7,62 - PCB connector





1716926

<https://www.phoenixcontact.com/sk/products/1716926>

Approvals

To download certificates, visit the product detail page: <https://www.phoenixcontact.com/sk/products/1716926>

 cULus Recognized Approval ID: E60425-20010727				
	Nominal voltage U_N	Nominal current I_N	Cross section AWG	Cross section mm^2
Use group B				
Standard	600 V	35 A	18 - 8	-
Use group C				
Standard	600 V	35 A	18 - 8	-
Use group F				
USR application only	600 V	35 A	18 - 8	-

 VDE Zeichengenehmigung Approval ID: 40050635				
	Nominal voltage U_N	Nominal current I_N	Cross section AWG	Cross section mm^2
Only flexible conductors	630 V	41 A	-	0.75 - 6
Only rigid conductors	630 V	41 A	-	0.75 - 10

LPC 6/ 6-ST-7,62 - PCB connector



1716926

<https://www.phoenixcontact.com/sk/products/1716926>

Classifications

ECLASS

ECLASS-11.0	27460202
ECLASS-12.0	27460202
ECLASS-13.0	27460202

ETIM

ETIM 9.0	EC002638
----------	----------

UNSPSC

UNSPSC 21.0	39121400
-------------	----------

LPC 6/ 6-ST-7,62 - PCB connector



1716926

<https://www.phoenixcontact.com/sk/products/1716926>

Environmental product compliance

EU RoHS

Fulfills EU RoHS substance requirements	Yes, No exemptions
---	--------------------

China RoHS

Environment friendly use period (EFUP)	EFUP-E
	No hazardous substances above the limits

EU REACH SVHC

REACH candidate substance (CAS No.)	No substance above 0.1 wt%
-------------------------------------	----------------------------

LPC 6/ 6-ST-7,62 - PCB connector

1716926

<https://www.phoenixcontact.com/sk/products/1716926>

Accessories

CP-PC RD - Coding profile

1701967

<https://www.phoenixcontact.com/sk/products/1701967>

Coding profile, for plugging into the coding ribs of the plug at a later date, insulating material, color: Red

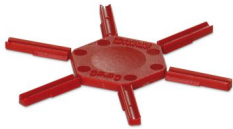

AI 6 -18 YE - Ferrule

3200603

<https://www.phoenixcontact.com/sk/products/3200603>

Ferrule, Length contact range: 18 mm, sleeve length: 26 mm, color: yellow



LPC 6/ 6-ST-7,62 - PCB connector

1716926

<https://www.phoenixcontact.com/sk/products/1716926>



CRIMPFOX CENTRUS 6S - Crimping pliers

1213144

<https://www.phoenixcontact.com/sk/products/1213144>



Crimping pliers, for uninsulated and insulated ferrules, DIN 46228 Part 1 and 4, from 0.14 mm² ... 6 mm², also for TWIN ferrules up to 2 x 4 mm², automatic cross section adjustment, lateral insertion, equipped with fall protection

WIREFOX 10 - Stripping tool

1212150

<https://www.phoenixcontact.com/sk/products/1212150>



Stripping tool, for cables and conductors from 0.02 - 10 mm², self-adjusting, stripping length of up to 18 mm, cutting capacity of up to 10 mm² stranded/1.5 mm² solid, replaceable stripping blade

LPC 6/ 6-ST-7,62 - PCB connector

1716926

<https://www.phoenixcontact.com/sk/products/1716926>

PC 6/ 6-G-7,62 P26THR - PCB header

1190494

<https://www.phoenixcontact.com/sk/products/1190494>



PCB headers, nominal cross section: 6 mm², color: black, nominal current: 41 A, rated voltage (III/2): 630 V, contact surface: Sn, contact connection type: Pin, number of rows: 1, number of positions: 6, product range: PC 6/...-G-THR, pitch: 7.62 mm, mounting: THR soldering / wave soldering, pin layout: Linear pinning, solder pin [P]: 2.6 mm, number of solder pins per potential: 3, plug-in system: COMBICON PC 6, Pin connector pattern alignment: Standard, locking: without, mounting: without, type of packaging: packed in cardboard

PC 6/ 6-GU-7,62 P26THR - PCB header

1192640

<https://www.phoenixcontact.com/sk/products/1192640>

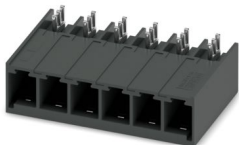

PCB headers, nominal cross section: 6 mm², color: black, nominal current: 41 A, rated voltage (III/2): 630 V, contact surface: Sn, contact connection type: Pin, number of rows: 1, number of positions: 6, product range: PC 6/...-GU-THR, pitch: 7.62 mm, mounting: THR soldering / wave soldering, pin layout: Linear pinning, solder pin [P]: 2.6 mm, number of solder pins per potential: 3, plug-in system: COMBICON PC 6, Pin connector pattern alignment: reversed, locking: without, mounting: without, type of packaging: packed in cardboard

LPC 6/ 6-ST-7,62 - PCB connector

1716926

<https://www.phoenixcontact.com/sk/products/1716926>



PCV 6/ 6-G-7,62 P26THR - PCB header

1192631

<https://www.phoenixcontact.com/sk/products/1192631>



PCB headers, nominal cross section: 6 mm², color: black, nominal current: 41 A, rated voltage (III/2): 630 V, contact surface: Sn, contact connection type: Pin, number of rows: 1, number of positions: 6, product range: PCV 6/..-G-THR, pitch: 7.62 mm, mounting: THR soldering / wave soldering, pin layout: Linear pinning, solder pin [P]: 2.6 mm, number of solder pins per potential: 3, plug-in system: COMBICON PC 6, Pin connector pattern alignment: Standard, locking: without, mounting: without, type of packaging: packed in cardboard

PC 6/ 6-G-7,62 - PCB header

1717021

<https://www.phoenixcontact.com/sk/products/1717021>

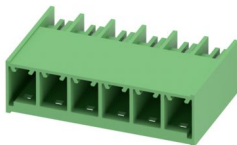

PCB headers, nominal cross section: 6 mm², color: green, nominal current: 41 A, rated voltage (III/2): 630 V, contact surface: Sn, contact connection type: Pin, number of potentials: 6, number of rows: 1, number of positions: 6, number of connections: 6, product range: PC 6/..-G, pitch: 7.62 mm, mounting: Wave soldering, pin layout: Linear pinning, solder pin [P]: 2.6 mm, number of solder pins per potential: 3, plug-in system: COMBICON PC 6, Pin connector pattern alignment: Standard, locking: without, mounting: without, type of packaging: packed in cardboard

LPC 6/ 6-ST-7,62 - PCB connector

1716926

<https://www.phoenixcontact.com/sk/products/1716926>



PC 6/ 6-GU-7,62 - PCB header

1136004

<https://www.phoenixcontact.com/sk/products/1136004>

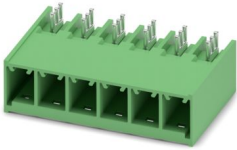

PCB headers, nominal cross section: 6 mm², color: green, nominal current: 41 A, rated voltage (III/2): 630 V, contact surface: Sn, contact connection type: Pin, number of potentials: 6, number of rows: 1, number of positions: 6, number of connections: 6, product range: PC 6/..-GU, pitch: 7.62 mm, mounting: Wave soldering, pin layout: Linear pinning, solder pin [P]: 2.6 mm, number of solder pins per potential: 3, plug-in system: COMBICON PC 6, Pin connector pattern alignment: reversed, locking: without, mounting: without, type of packaging: packed in cardboard

PCV 6/ 6-G-7,62 - PCB header

1131535

<https://www.phoenixcontact.com/sk/products/1131535>



PCB headers, nominal cross section: 6 mm², color: green, nominal current: 41 A, rated voltage (III/2): 630 V, contact surface: Sn, contact connection type: Pin, number of potentials: 6, number of rows: 1, number of positions: 6, number of connections: 6, product range: PCV 6/..-G, pitch: 7.62 mm, mounting: Wave soldering, pin layout: Linear pinning, solder pin [P]: 2.6 mm, number of solder pins per potential: 3, plug-in system: COMBICON PC 6, Pin connector pattern alignment: Standard, locking: without, mounting: without, type of packaging: packed in cardboard

Phoenix Contact 2024 © - all rights reserved
<https://www.phoenixcontact.com>

PHOENIX CONTACT s.r.o.
Námestie Mateja Korvína 1
811 07 Bratislava
+421 2 3210 1470
obchod.sk@phoenixcontact.com