

2JP1004P

CELLULAR Rigid Fiberglass

Key Features

CELLULAR

- 824-960 MHz

- 1710-2170 MHz

Embedded Antenna

Self-Adhesive

Small Form Factor

Ground Plane Independent

Dimensions 37.8 × 7.2 × 0.8 mm

Customizable Cable and Connector

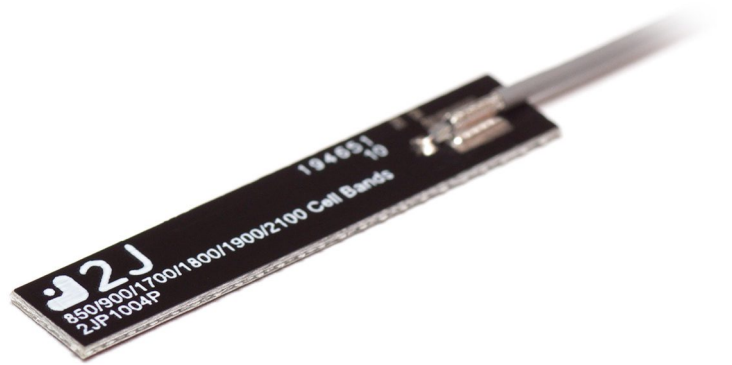

1. Antenna and electrical specifications

Parameters	CELLULAR Antenna	
Standards	2G and 3G	
Band (MHz)	850/900	1700/1800/1900/2100
Frequency (MHz)	824-960	1710-2170
Return Loss (dB)	~ -5.7	~ -3.0
VSWR	~ 4.0:1	~ 6.0:1
Efficiency (%)	~ 37.8	~ 38.7
Peak Gain (dBi)	~ 1.1	~ 1.3
Average Gain (dB)	~ -4.3	~ -4.1
Impedance (Ohm)	50	
Polarisation	Linear	
Radiation Pattern	Omni-Directional	
Max. Input Power (W)	25	
Connector Type	Most RF Connectors (U.FL Standard)	
Cable Length	Any Cable Length (100mm Standard)	
Cable Type	Other Cables Available (1.37mm Standard)	

Antenna Measurement Conditions:

Mounted on 30 x 30 x 0.25 cm ABS Plate

100 mm 1.37 mm Cable

Measured in Certified CTIA 3D Anechoic Chamber

2. Mechanical and environmental specifications

Specifications	2JP1004P
Mounting Type	Self-Adhesive
Dimensions (mm)	37.8 × 7.2 × 0.8 mm
Adhesive Type	3M 467
Material	Rigid Fiberglass
Operating Temperature (C)	-40 to +85
Storage Temperature (C)	-40 to +85
Substance Compliance	RoHS

3. Antenna parameters

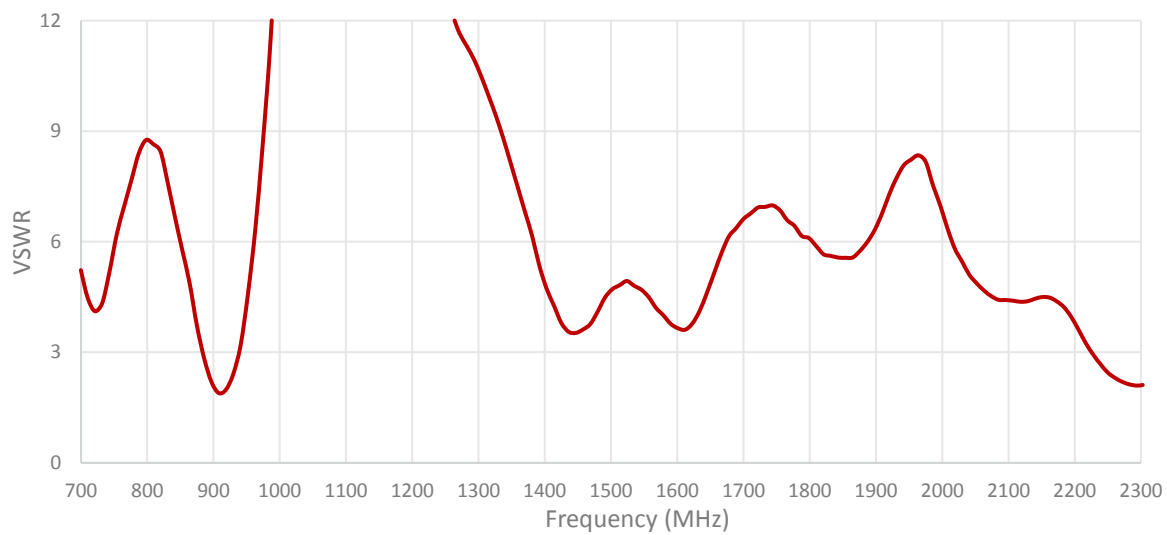
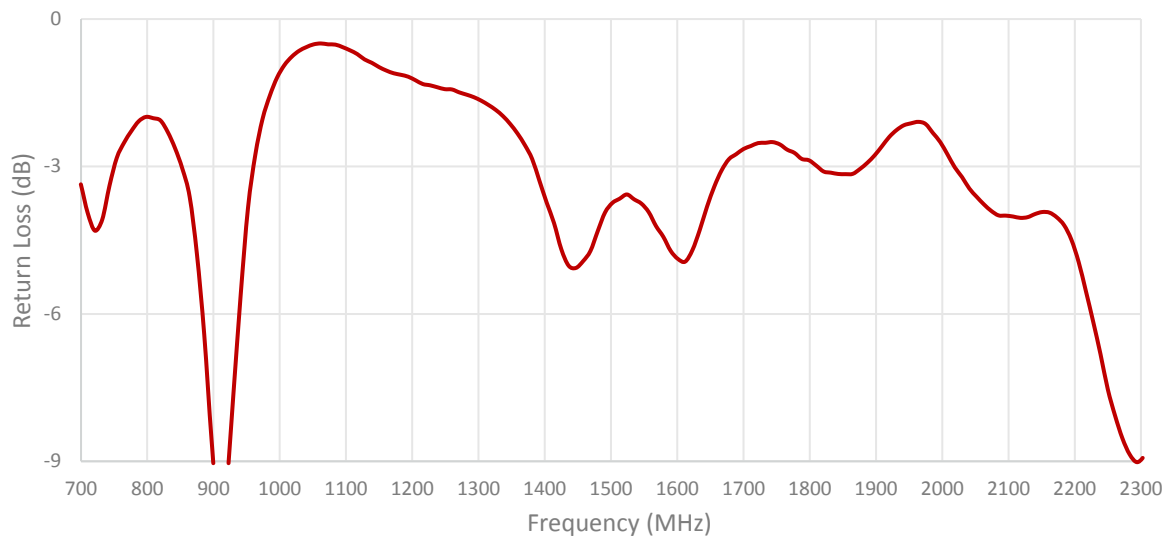

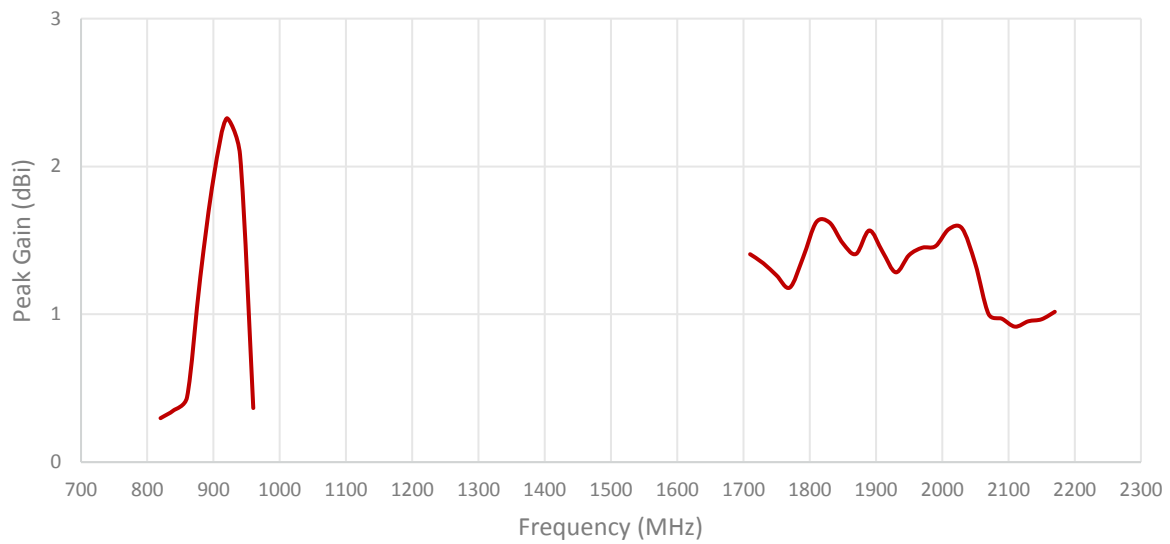
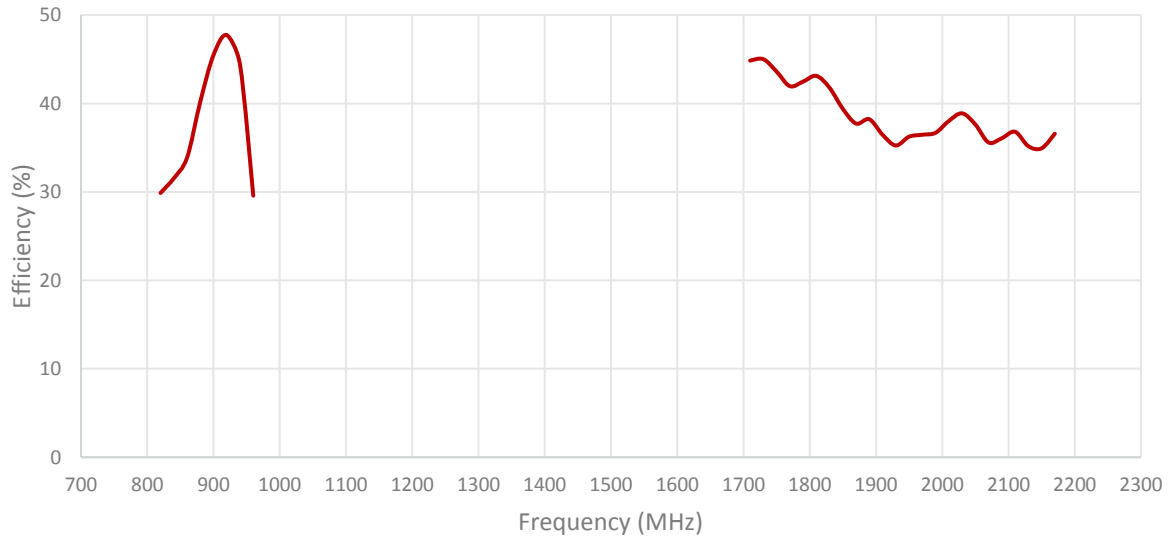

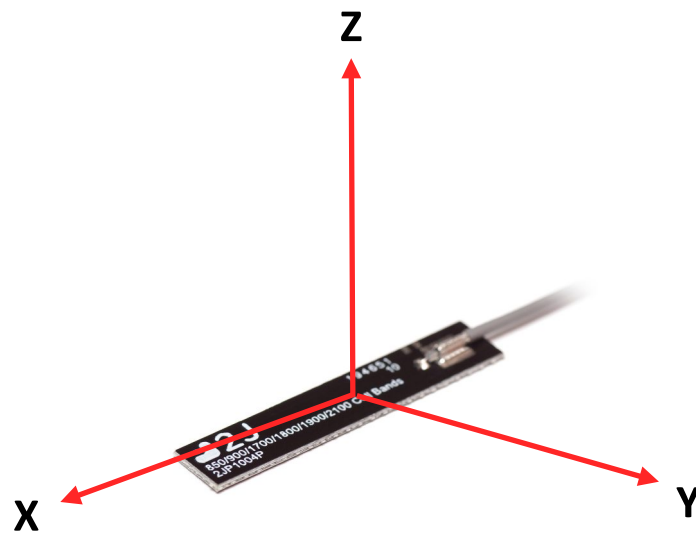
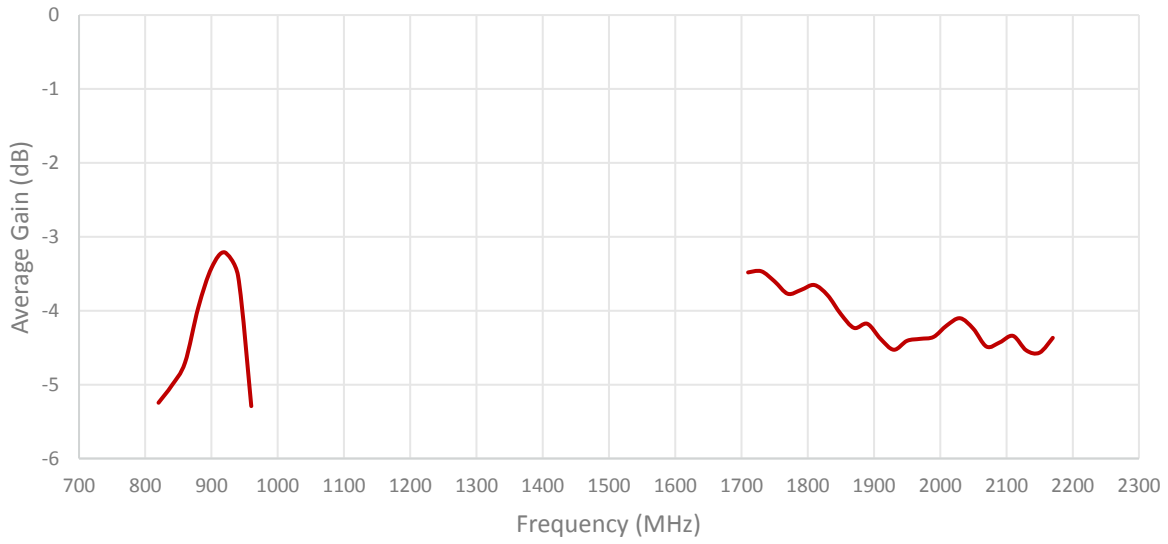

Radiation pattern reference

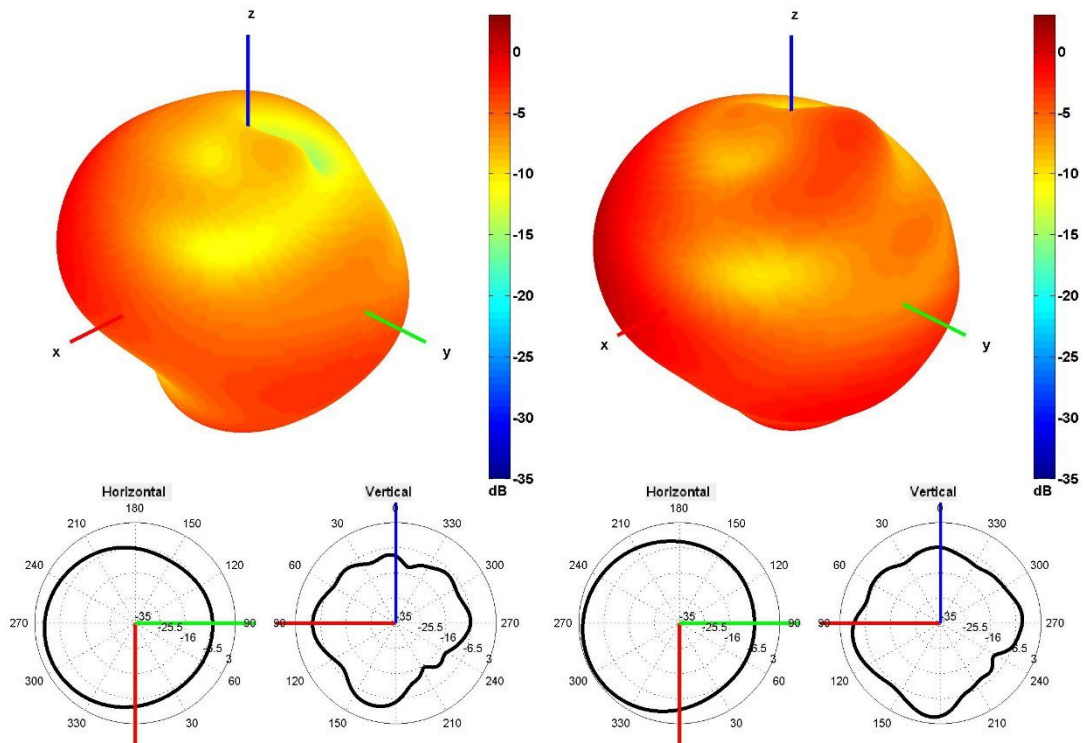

850 and 940 MHz Radiation pattern

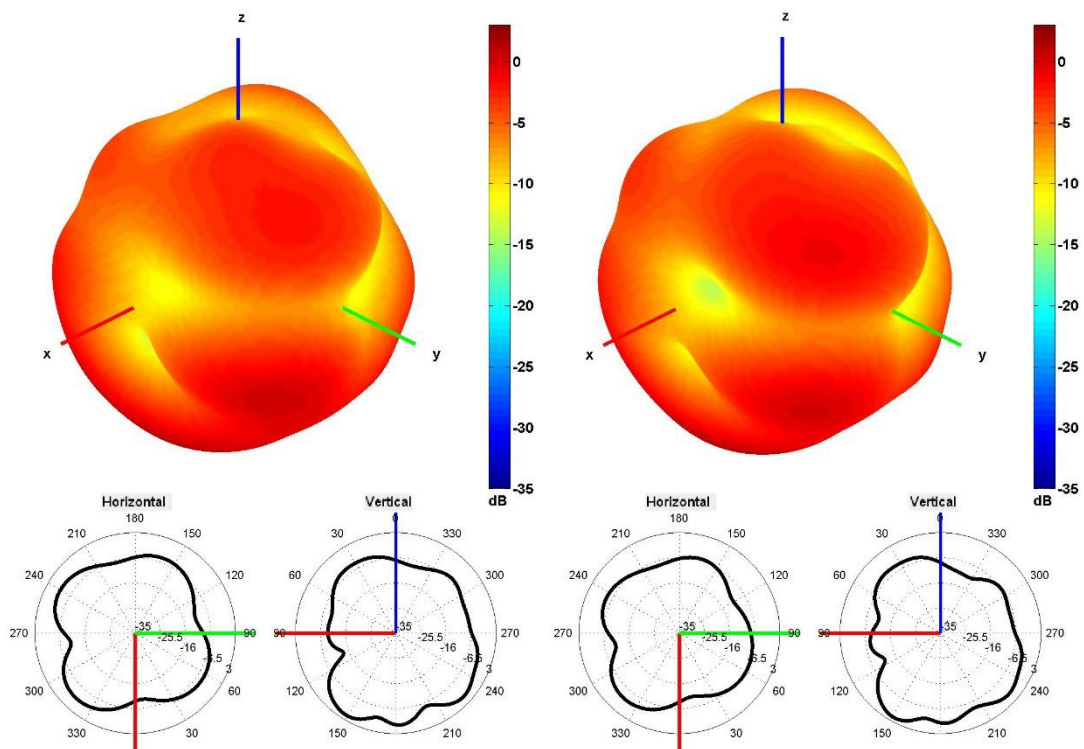

1750 and 1850 MHz Radiation pattern

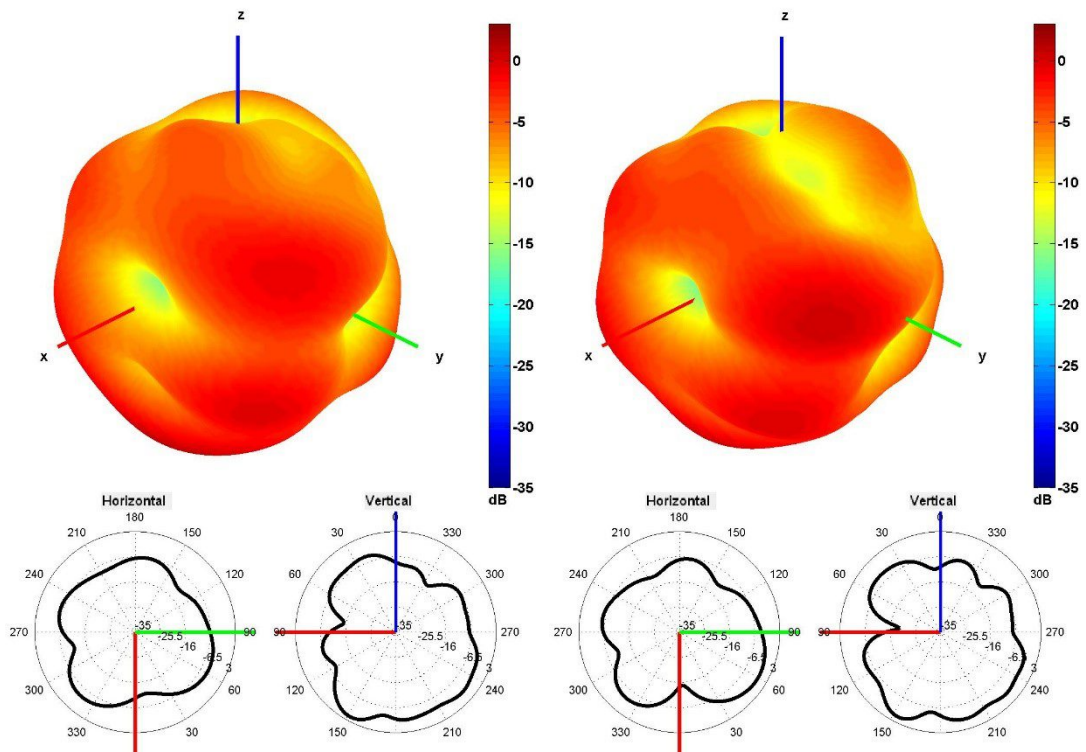

1950 and 2100 MHz Radiation pattern

4. Antenna drawings

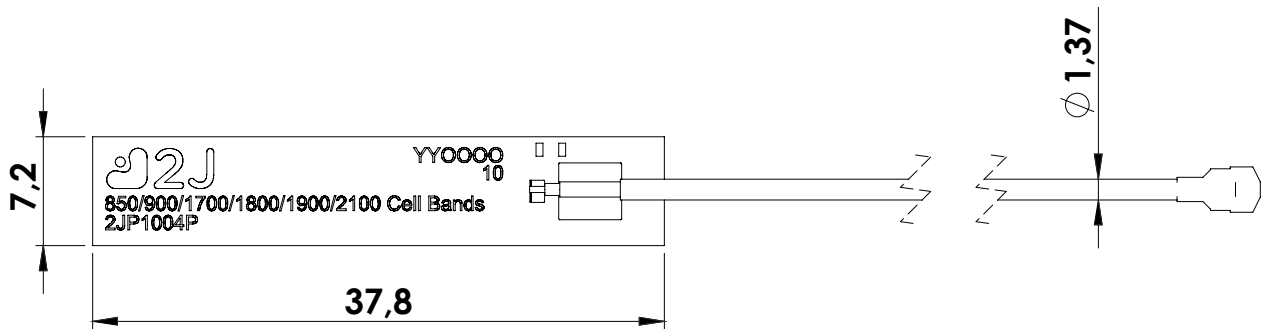
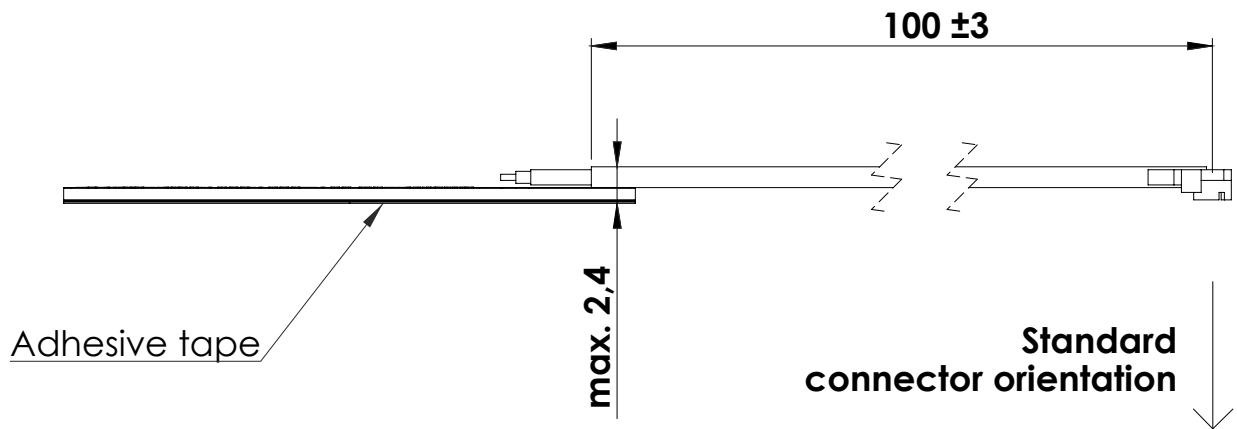

5. Antenna Images

