

μA78L00 SERIES POSITIVE-VOLTAGE REGULATORS

SLVS010I – JANUARY 1976 – REVISED JULY 1999

- 3-Terminal Regulators
- Output Current up to 100 mA
- No External Components
- Internal Thermal-Overload Protection
- Internal Short-Circuit Current Limiting
- Direct Replacements for Fairchild μA78L00 Series

description

This series of fixed-voltage integrated-circuit voltage regulators is designed for a wide range of applications. These applications include on-card regulation for elimination of noise and distribution problems associated with single-point regulation. In addition, they can be used with power-pass elements to make high-current voltage regulators. One of these regulators can deliver up to 100 mA of output current. The internal limiting and thermal-shutdown features of these regulators make them essentially immune to overload. When used as a replacement for a zener diode-resistor combination, an effective improvement in output impedance can be obtained, together with lower bias current.

The μA78L00C series is characterized for operation over the virtual junction temperature range of 0°C to 125°C.

**D PACKAGE
(TOP VIEW)**

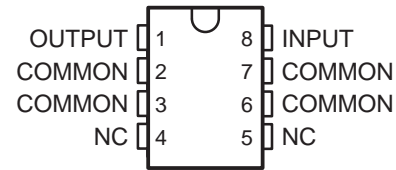

NC – No internal connection

**LP PACKAGE
(TOP VIEW)**

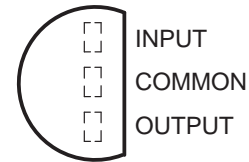

TO-226AA

**PK PACKAGE
(TOP VIEW)**

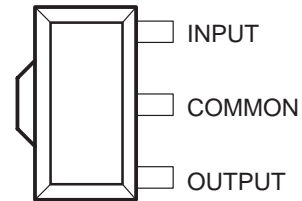

AVAILABLE OPTIONS

T _J	V _{O(NOM)} (V)	PACKAGED DEVICES						CHIP FORM (Y)
		SMALL OUTLINE (D)		PLASTIC CYLINDRICAL (LP)		SOT-89 (PK)		
		OUTPUT VOLTAGE TOLERANCE						
		5%	10%	5%	10%	5%	10%	
0°C to 125°C	2.6	μA78L02ACD	–	μA78L02ACLP	μA78L02CLP	μA78L02ACPK	μA78L02CPK	μA78L02Y
	5	μA78L05ACD	μA78L05CD	μA78L05ACLP	μA78L05CLP	μA78L05ACPK	μA78L05CPK	μA78L05Y
	6.2	μA78L06ACD	μA78L06CD	μA78L06ACLP	μA78L06CLP	μA78L06ACPK	μA78L06CPK	μA78L06Y
	8	μA78L08ACD	μA78L08CD	μA78L08ACLP	μA78L08CLP	μA78L08ACPK	μA78L08CPK	μA78L08Y
	9	μA78L09ACD	μA78L09CD	μA78L09ACLP	μA78L09CLP	μA78L09ACPK	μA78L09CPK	μA78L09Y
	10	μA78L10ACD	–	μA78L10ACLP	μA78L10CLP	μA78L10ACPK	μA78L10CPK	μA78L10Y
	12	μA78L12ACD	μA78L12CD	μA78L12ACLP	μA78L12CLP	μA78L12ACPK	μA78L12CPK	μA78L12Y
	15	μA78L15ACD	μA78L15CD	μA78L15ACLP	μA78L15CLP	μA78L15ACPK	μA78L15CPK	μA78L15Y

D and LP packages are available taped and reeled. Add the suffix R to the device type (e.g., μA78L05ACDR). The PK package is only available taped and reeled (e.g., μA78L02ACPKR). Chip forms are tested at T_A = 25°C.



Please be aware that an important notice concerning availability, standard warranty, and use in critical applications of Texas Instruments semiconductor products and disclaimers thereto appears at the end of this data sheet.

PRODUCTION DATA information is current as of publication date. Products conform to specifications per the terms of Texas Instruments standard warranty. Production processing does not necessarily include testing of all parameters.

**TEXAS
INSTRUMENTS**

POST OFFICE BOX 655303 • DALLAS, TEXAS 75265

Copyright © 1999, Texas Instruments Incorporated

μA78L00 SERIES POSITIVE-VOLTAGE REGULATORS

SLVS010I – JANUARY 1976 – REVISED JULY 1999

schematic

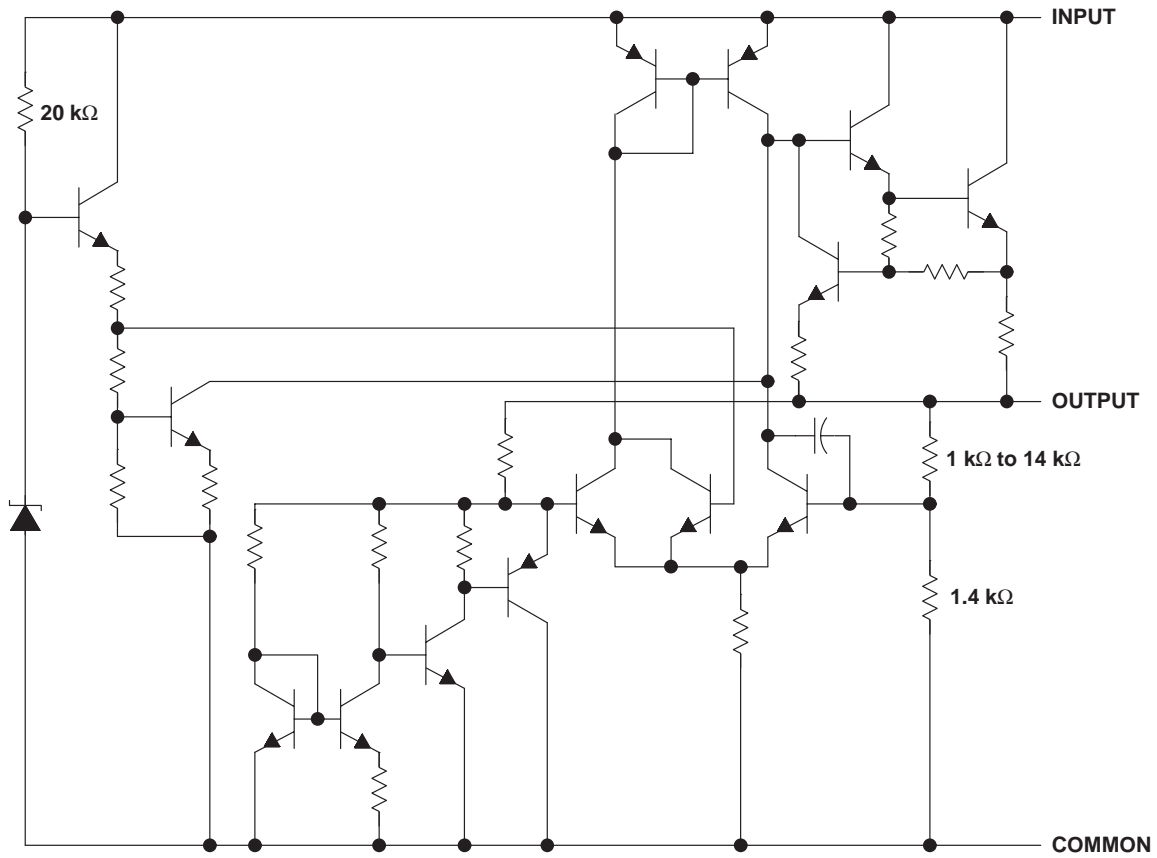

NOTE: Resistor values shown are nominal.

μA78L00 SERIES POSITIVE-VOLTAGE REGULATORS

SLVS010I – JANUARY 1976 – REVISED JULY 1999

absolute maximum ratings over operating temperature range (unless otherwise noted)†

	μA78Lxx	UNIT
Input voltage, V_I	μA78L02AC, μA78L05C–μA78L09C, μA78L10AC	30
	μA78L12C, μA78L12AC, μA78L15C, μA78L15AC	35
Package thermal impedance, θ_{JA} (see Notes 1 and 2)	D package	97
	LP package	156
	PK package	52
Virtual junction temperature range, T_J	0 to 150	°C
Lead temperature 1,6 mm (1/16 inch) from case for 10 seconds	260	°C
Storage temperature range, T_{stg}	–65 to 150	°C

† Stresses beyond those listed under “absolute maximum ratings” may cause permanent damage to the device. These are stress ratings only, and functional operation of the device at these or any other conditions beyond those indicated under “recommended operating conditions” is not implied. Exposure to absolute-maximum-rated conditions for extended periods may affect device reliability.

- NOTES:
1. Maximum power dissipation is a function of $T_{J(max)}$, θ_{JA} , and T_A . The maximum allowable power dissipation at any allowable ambient temperature is $P_D = (T_{J(max)} - T_A)/\theta_{JA}$. Operating at the absolute maximum T_J of 150°C can impact reliability. Due to variations in individual device electrical characteristics and thermal resistance, the built-in thermal-overload protection may be activated at power levels slightly above or below the rated dissipation.
 2. The package thermal impedance is calculated in accordance with JESD 51, except for through-hole packages, which use a trace length of zero.

recommended operating conditions

		MIN	MAX	UNIT
Input voltage, V_I	μA78L02AC	4.75	20	V
	μA78L05C, μA78L05AC	7	20	
	μA78L06C, μA78L06AC	8.5	20	
	μA78L08C, μA78L08AC	10.5	23	
	μA78L09C, μA78L09AC	11.5	24	
	μA78L10AC	12.5	25	
	μA78L12C, μA78L12AC	14.5	27	
	μA78L15C, μA78L15AC	17.5	30	
Output current, I_O			100	mA
Operating virtual junction temperature, T_J		0	125	°C



μA78L00 SERIES POSITIVE-VOLTAGE REGULATORS

SLVS010I – JANUARY 1976 – REVISED JULY 1999

electrical characteristics at specified virtual junction temperature, $V_I = 9\text{ V}$, $I_O = 40\text{ mA}$ (unless otherwise noted)

PARAMETER	TEST CONDITIONS	T_J †	μA78L02C			UNIT
			MIN	TYP	MAX	
Output voltage	$V_I = 4.75\text{ V to }20\text{ V}$, $I_O = 1\text{ mA to }40\text{ mA}$	25°C	2.5	2.6	2.7	V
		0°C to 125°C	2.45		2.75	
	$I_O = 1\text{ mA to }70\text{ mA}$	0°C to 125°C	2.45		2.75	
Input voltage regulation	$V_I = 4.75\text{ V to }20\text{ V}$	25°C	20		100	mV
	$V_I = 5\text{ V to }20\text{ V}$		16		75	
Ripple rejection	$V_I = 6\text{ V to }20\text{ V}$, $f = 120\text{ Hz}$	25°C	43	51		dB
Output voltage regulation	$I_O = 1\text{ mA to }100\text{ mA}$	25°C	12		50	mV
	$I_O = 1\text{ mA to }40\text{ mA}$		6		25	
Output noise voltage	$f = 10\text{ Hz to }100\text{ kHz}$	25°C	30			μV
Dropout voltage		25°C	1.7			V
Bias current		25°C	3.6		6	mA
		125°C			5.5	
Bias current change	$V_I = 5\text{ V to }20\text{ V}$	0°C to 125°C			2.5	mA
	$I_O = 1\text{ mA to }40\text{ mA}$				0.1	

† Pulse-testing techniques maintain T_J as close to T_A as possible. Thermal effects must be taken into account separately. All characteristics are measured with a 0.33-μF capacitor across the input and a 0.1-μF capacitor across the output.

electrical characteristics at specified virtual junction temperature, $V_I = 10\text{ V}$, $I_O = 40\text{ mA}$ (unless otherwise noted)

PARAMETER	TEST CONDITIONS	T_J †	μA78L05C			μA78L05AC			UNIT
			MIN	TYP	MAX	MIN	TYP	MAX	
Output voltage	$V_I = 7\text{ V to }20\text{ V}$, $I_O = 1\text{ mA to }40\text{ mA}$	25°C	4.6	5	5.4	4.8	5	5.2	V
		0°C to 125°C	4.5		5.5	4.75		5.25	
	$I_O = 1\text{ mA to }70\text{ mA}$	0°C to 125°C	4.5		5.5	4.75		5.25	
Input voltage regulation	$V_I = 7\text{ V to }20\text{ V}$	25°C	32		200	32		150	mV
	$V_I = 8\text{ V to }20\text{ V}$		26		150	26		100	
Ripple rejection	$V_I = 8\text{ V to }18\text{ V}$, $f = 120\text{ Hz}$	25°C	40	49		41	49		dB
Output voltage regulation	$I_O = 1\text{ mA to }100\text{ mA}$	25°C	15		60	15		60	mV
	$I_O = 1\text{ mA to }40\text{ mA}$		8		30	8		30	
Output noise voltage	$f = 10\text{ Hz to }100\text{ kHz}$	25°C	42			42			μV
Dropout voltage		25°C	1.7			1.7			V
Bias current		25°C	3.8		6	3.8		6	mA
		125°C			5.5			5.5	
Bias current change	$V_I = 8\text{ V to }20\text{ V}$	0°C to 125°C			1.5			1.5	mA
	$I_O = 1\text{ mA to }40\text{ mA}$				0.2			0.1	

† Pulse-testing techniques maintain T_J as close to T_A as possible. Thermal effects must be taken into account separately. All characteristics are measured with a 0.33-μF capacitor across the input and a 0.1-μF capacitor across the output.



POST OFFICE BOX 655303 • DALLAS, TEXAS 75265

μA78L00 SERIES POSITIVE-VOLTAGE REGULATORS

SLVS010I – JANUARY 1976 – REVISED JULY 1999

electrical characteristics at specified virtual junction temperature, $V_I = 12\text{ V}$, $I_O = 40\text{ mA}$ (unless otherwise noted)

PARAMETER	TEST CONDITIONS	T_J †	μA78L06C			μA78L06AC			UNIT
			MIN	TYP	MAX	MIN	TYP	MAX	
Output voltage	$V_I = 8.5\text{ V to }20\text{ V}$, $I_O = 1\text{ mA to }40\text{ mA}$	25°C	5.7	6.2	6.7	5.95	6.2	6.45	V
		0°C to 125°C	5.6		6.8	5.9		6.5	
	$I_O = 1\text{ mA to }70\text{ mA}$	0°C to 125°C	5.6		6.8	5.9		6.5	
Input voltage regulation	$V_I = 8.5\text{ V to }20\text{ V}$	25°C	35		200	35		175	mV
	$V_I = 9\text{ V to }20\text{ V}$		29		150	29		125	
Ripple rejection	$V_I = 10\text{ V to }20\text{ V}$, $f = 120\text{ Hz}$	25°C	39	48		40	48		dB
Output voltage regulation	$I_O = 1\text{ mA to }100\text{ mA}$	25°C	16		80	16		80	mV
	$I_O = 1\text{ mA to }40\text{ mA}$		9		40	9		40	
Output noise voltage	$f = 10\text{ Hz to }100\text{ kHz}$	25°C	46			46			μV
Dropout voltage		25°C	1.7			1.7			V
Bias current		25°C	3.9		6	3.9		6	mA
		125°C			5.5			5.5	
Bias current change	$V_I = 9\text{ V to }20\text{ V}$	0°C to 125°C			1.5			1.5	mA
	$I_O = 1\text{ mA to }40\text{ mA}$				0.2			0.1	

† Pulse-testing techniques maintain T_J as close to T_A as possible. Thermal effects must be taken into account separately. All characteristics are measured with a 0.33-μF capacitor across the input and a 0.1-μF capacitor across the output.

electrical characteristics at specified virtual junction temperature, $V_I = 14\text{ V}$, $I_O = 40\text{ mA}$ (unless otherwise noted)

PARAMETER	TEST CONDITIONS	T_J †	μA78L08C			μA78L08AC			UNIT
			MIN	TYP	MAX	MIN	TYP	MAX	
Output voltage	$V_I = 10.5\text{ V to }23\text{ V}$, $I_O = 1\text{ mA to }40\text{ mA}$	25°C	7.36	8	8.64	7.7	8	8.3	V
		0°C to 125°C	7.2		8.8	7.6		8.4	
	$I_O = 1\text{ mA to }70\text{ mA}$	0°C to 125°C	7.2		8.8	7.6		8.4	
Input voltage regulation	$V_I = 10.5\text{ V to }23\text{ V}$	25°C	42		200	42		175	mV
	$V_I = 11\text{ V to }23\text{ V}$		36		150	36		125	
Ripple rejection	$V_I = 13\text{ V to }23\text{ V}$, $f = 120\text{ Hz}$	25°C	36	46		37	46		dB
Output voltage regulation	$I_O = 1\text{ mA to }100\text{ mA}$	25°C	18		80	18		80	mV
	$I_O = 1\text{ mA to }40\text{ mA}$		10		40	10		40	
Output noise voltage	$f = 10\text{ Hz to }100\text{ kHz}$	25°C	54			54			μV
Dropout voltage		25°C	1.7			1.7			V
Bias current		25°C	4		6	4		6	mA
		125°C			5.5			5.5	
Bias current change	$V_I = 5\text{ V to }20\text{ V}$	0°C to 125°C			1.5			1.5	mA
	$I_O = 1\text{ mA to }40\text{ mA}$				0.2			0.1	

† Pulse-testing techniques maintain T_J as close to T_A as possible. Thermal effects must be taken into account separately. All characteristics are measured with a 0.33-μF capacitor across the input and a 0.1-μF capacitor across the output.



μA78L00 SERIES POSITIVE-VOLTAGE REGULATORS

SLVS010I – JANUARY 1976 – REVISED JULY 1999

electrical characteristics at specified virtual junction temperature, $V_I = 16\text{ V}$, $I_O = 40\text{ mA}$ (unless otherwise noted)

PARAMETER	TEST CONDITIONS	T_J †	μA78L09C			μA78L09AC			UNIT
			MIN	TYP	MAX	MIN	TYP	MAX	
Output voltage	$V_I = 12\text{ V to }24\text{ V}$, $I_O = 1\text{ mA to }40\text{ mA}$	25°C	8.3	9	9.7	8.6	9	9.4	V
		0°C to 125°C	8.1		9.9	8.55		9.45	
	$I_O = 1\text{ mA to }70\text{ mA}$	0°C to 125°C	8.1		9.9	8.55		9.45	
Input voltage regulation	$V_I = 12\text{ V to }24\text{ V}$	25°C		45	225		45	175	mV
	$V_I = 13\text{ V to }24\text{ V}$			40	175		40	125	
Ripple rejection	$V_I = 15\text{ V to }25\text{ V}$, $f = 120\text{ Hz}$	25°C	36	45		38	45		dB
Output voltage regulation	$I_O = 1\text{ mA to }100\text{ mA}$	25°C		19	90		19	90	mV
	$I_O = 1\text{ mA to }40\text{ mA}$			11	40		11	40	
Output noise voltage	$f = 10\text{ Hz to }100\text{ kHz}$	25°C		58			58		μV
Dropout voltage		25°C		1.7			1.7		V
Bias current		25°C		4.1	6		4.1	6	mA
		125°C			5.5			5.5	
Bias current change	$V_I = 13\text{ V to }24\text{ V}$	0°C to 125°C			1.5			1.5	mA
	$I_O = 1\text{ mA to }40\text{ mA}$				0.2			0.1	

† Pulse-testing techniques maintain T_J as close to T_A as possible. Thermal effects must be taken into account separately. All characteristics are measured with a 0.33-μF capacitor across the input and a 0.1-μF capacitor across the output.

electrical characteristics at specified virtual junction temperature, $V_I = 14\text{ V}$, $I_O = 40\text{ mA}$ (unless otherwise noted)

PARAMETER	TEST CONDITIONS	T_J †	μA78L10AC			UNIT
			MIN	TYP	MAX	
Output voltage	$V_I = 13\text{ V to }25\text{ V}$, $I_O = 1\text{ mA to }40\text{ mA}$	25°C	9.6	10	10.4	V
		0°C to 125°C	9.5		10.5	
	$I_O = 1\text{ mA to }70\text{ mA}$	0°C to 125°C	9.5		10.5	
Input voltage regulation	$V_I = 13\text{ V to }25\text{ V}$	25°C		51	175	mV
	$V_I = 14\text{ V to }25\text{ V}$			42	125	
Ripple rejection	$V_I = 15\text{ V to }25\text{ V}$, $f = 120\text{ Hz}$	25°C	37	44		dB
Output voltage regulation	$I_O = 1\text{ mA to }100\text{ mA}$	25°C		20	90	mV
	$I_O = 1\text{ mA to }40\text{ mA}$			11	40	
Output noise voltage	$f = 10\text{ Hz to }100\text{ kHz}$	25°C		62		μV
Dropout voltage		25°C		1.7		V
Bias current		25°C		4.2	6	mA
		125°C			5.5	
Bias current change	$V_I = 14\text{ V to }25\text{ V}$	0°C to 125°C			1.5	mA
	$I_O = 1\text{ mA to }40\text{ mA}$				0.1	

† Pulse-testing techniques maintain T_J as close to T_A as possible. Thermal effects must be taken into account separately. All characteristics are measured with a 0.33-μF capacitor across the input and a 0.1-μF capacitor across the output.



POST OFFICE BOX 655303 • DALLAS, TEXAS 75265

μA78L00 SERIES POSITIVE-VOLTAGE REGULATORS

SLVS010I – JANUARY 1976 – REVISED JULY 1999

electrical characteristics at specified virtual junction temperature, $V_I = 19\text{ V}$, $I_O = 40\text{ mA}$ (unless otherwise noted)

PARAMETER	TEST CONDITIONS	T_J †	μA78L12C			μA78L12AC			UNIT
			MIN	TYP	MAX	MIN	TYP	MAX	
Output voltage	$V_I = 14\text{ V to }27\text{ V}$, $I_O = 1\text{ mA to }40\text{ mA}$	25°C	11.1	12	12.9	11.5	12	12.5	V
		0°C to 125°C	10.8		13.2	11.4		12.6	
	$I_O = 1\text{ mA to }70\text{ mA}$	0°C to 125°C	10.8		13.2	11.4		12.6	
Input voltage regulation	$V_I = 14.5\text{ V to }27\text{ V}$	25°C	55		250	55		250	mV
	$V_I = 16\text{ V to }27\text{ V}$		49		200	49		200	
Ripple rejection	$V_I = 15\text{ V to }25\text{ V}$, $f = 120\text{ Hz}$	25°C	36	42		37	42	dB	
Output voltage regulation	$I_O = 1\text{ mA to }100\text{ mA}$	25°C	22		100	22		100	mV
	$I_O = 1\text{ mA to }40\text{ mA}$		13		50	13		50	
Output noise voltage	$f = 10\text{ Hz to }100\text{ kHz}$	25°C	70			70			μV
Dropout voltage		25°C	1.7			1.7			V
Bias current		25°C	4.3		6.5	4.3		6.5	mA
		125°C	6			6			
Bias current change	$V_I = 16\text{ V to }27\text{ V}$	0°C to 125°C	1.5			1.5			mA
	$I_O = 1\text{ mA to }40\text{ mA}$		0.2			0.1			

† Pulse-testing techniques maintain T_J as close to T_A as possible. Thermal effects must be taken into account separately. All characteristics are measured with a 0.33-μF capacitor across the input and a 0.1-μF capacitor across the output.

electrical characteristics at specified virtual junction temperature, $V_I = 23\text{ V}$, $I_O = 40\text{ mA}$ (unless otherwise noted)

PARAMETER	TEST CONDITIONS	T_J †	μA78L15C			μA78L15AC			UNIT
			MIN	TYP	MAX	MIN	TYP	MAX	
Output voltage	$V_I = 17.5\text{ V to }30\text{ V}$, $I_O = 1\text{ mA to }40\text{ mA}$	25°C	13.8	15	16.2	14.4	15	15.6	V
		0°C to 125°C	13.5		16.5	14.25		15.75	
	$I_O = 1\text{ mA to }70\text{ mA}$	0°C to 125°C	13.5		16.5	14.25		15.75	
Input voltage regulation	$V_I = 17.5\text{ V to }30\text{ V}$	25°C	65		300	65		300	mV
	$V_I = 20\text{ V to }30\text{ V}$		58		250	58		250	
Ripple rejection	$V_I = 18.5\text{ V to }28.5\text{ V}$, $f = 120\text{ Hz}$	25°C	33	39		34	39	dB	
Output voltage regulation	$I_O = 1\text{ mA to }100\text{ mA}$	25°C	25		150	25		150	mV
	$I_O = 1\text{ mA to }40\text{ mA}$		15		75	15		75	
Output noise voltage	$f = 10\text{ Hz to }100\text{ kHz}$	25°C	82			82			μV
Dropout voltage		25°C	1.7			1.7			V
Bias current		25°C	4.6		6.5	4.6		6.5	mA
		125°C	6			6			
Bias current change	$V_I = 10\text{ V to }30\text{ V}$	0°C to 125°C	1.5			1.5			mA
	$I_O = 1\text{ mA to }40\text{ mA}$		0.2			0.1			

† Pulse-testing techniques maintain T_J as close to T_A as possible. Thermal effects must be taken into account separately. All characteristics are measured with a 0.33-μF capacitor across the input and a 0.1-μF capacitor across the output.



μA78L00 SERIES POSITIVE-VOLTAGE REGULATORS

SLVS010I – JANUARY 1976 – REVISED JULY 1999

electrical characteristics at specified virtual junction temperature, $V_I = 9\text{ V}$, $I_O = 40\text{ mA}$, $T_J = 25^\circ\text{C}$ (unless otherwise noted)

PARAMETER	TEST CONDITIONS†	μA78L02Y			UNIT
		MIN	TYP	MAX	
Output voltage			2.6		V
Input voltage regulation	$V_I = 4.75\text{ V to }20\text{ V}$		20		mV
	$V_I = 5\text{ V to }20\text{ V}$		16		
Ripple rejection	$V_I = 6\text{ V to }20\text{ V}$, $f = 120\text{ Hz}$		51		dB
Output voltage regulation	$I_O = 1\text{ mA to }100\text{ mA}$		12		mV
	$I_O = 1\text{ mA to }40\text{ mA}$		6		
Output noise voltage	$f = 10\text{ Hz to }100\text{ kHz}$		30		μV
Dropout voltage			1.7		V
Bias current			3.6		mA

† Pulse-testing techniques maintain T_J as close to T_A as possible. Thermal effects must be taken into account separately. All characteristics are measured with a 0.33-μF capacitor across the input and a 0.1-μF capacitor across the output.

electrical characteristics at specified virtual junction temperature, $V_I = 10\text{ V}$, $I_O = 40\text{ mA}$, $T_J = 25^\circ\text{C}$ (unless otherwise noted)

PARAMETER	TEST CONDITIONS†	μA78L05Y			UNIT
		MIN	TYP	MAX	
Output voltage			5		V
Input voltage regulation	$V_I = 7\text{ V to }20\text{ V}$		32		mV
	$V_I = 8\text{ V to }20\text{ V}$		26		
Ripple rejection	$V_I = 8\text{ V to }18\text{ V}$, $f = 120\text{ Hz}$		49		dB
Output voltage regulation	$I_O = 1\text{ mA to }100\text{ mA}$		15		mV
	$I_O = 1\text{ mA to }40\text{ mA}$		8		
Output noise voltage	$f = 10\text{ Hz to }100\text{ kHz}$		42		μV
Dropout voltage			1.7		V
Bias current			3.8		mA

† Pulse-testing techniques maintain T_J as close to T_A as possible. Thermal effects must be taken into account separately. All characteristics are measured with a 0.33-μF capacitor across the input and a 0.1-μF capacitor across the output.

electrical characteristics at specified virtual junction temperature, $V_I = 12\text{ V}$, $I_O = 40\text{ mA}$, $T_J = 25^\circ\text{C}$ (unless otherwise noted)

PARAMETER	TEST CONDITIONS†	μA78L06Y			UNIT
		MIN	TYP	MAX	
Output voltage			6.2		V
Input voltage regulation	$V_I = 8.5\text{ V to }20\text{ V}$		35		mV
	$V_I = 9\text{ V to }20\text{ V}$		29		
Ripple rejection	$V_I = 10\text{ V to }20\text{ V}$, $f = 120\text{ Hz}$		48		dB
Output voltage regulation	$I_O = 1\text{ mA to }100\text{ mA}$		16		mV
	$I_O = 1\text{ mA to }40\text{ mA}$		9		
Output noise voltage	$f = 10\text{ Hz to }100\text{ kHz}$		46		μV
Dropout voltage			1.7		V
Bias current			3.9		mA

† Pulse-testing techniques maintain T_J as close to T_A as possible. Thermal effects must be taken into account separately. All characteristics are measured with a 0.33-μF capacitor across the input and a 0.1-μF capacitor across the output.



μA78L00 SERIES POSITIVE-VOLTAGE REGULATORS

SLVS010I – JANUARY 1976 – REVISED JULY 1999

electrical characteristics at specified virtual junction temperature, $V_I = 14\text{ V}$, $I_O = 40\text{ mA}$, $T_J = 25^\circ\text{C}$ (unless otherwise noted)

PARAMETER	TEST CONDITION [†]	μA78L08Y			UNIT
		MIN	TYP	MAX	
Output voltage			8		V
Input voltage regulation	$V_I = 10.5\text{ V to }23\text{ V}$		42		mV
	$V_I = 11\text{ V to }23\text{ V}$		36		
Ripple rejection	$V_I = 13\text{ V to }23\text{ V}$, $f = 120\text{ Hz}$		46		dB
Output voltage regulation	$I_O = 1\text{ mA to }100\text{ mA}$		18		mV
	$I_O = 1\text{ mA to }40\text{ mA}$		10		
Output noise voltage	$f = 10\text{ Hz to }100\text{ kHz}$		54		μV
Dropout voltage			1.7		V
Bias current			4		mA

[†] Pulse-testing techniques maintain T_J as close to T_A as possible. Thermal effects must be taken into account separately. All characteristics are measured with a 0.33-μF capacitor across the input and a 0.1-μF capacitor across the output.

electrical characteristics at specified virtual junction temperature, $V_I = 16\text{ V}$, $I_O = 40\text{ mA}$, $T_J = 25^\circ\text{C}$ (unless otherwise noted)

PARAMETER	TEST CONDITION [†]	μA78L09Y			UNIT
		MIN	TYP	MAX	
Output voltage			9		V
Input voltage regulation	$V_I = 12\text{ V to }24\text{ V}$		45		mV
	$V_I = 13\text{ V to }24\text{ V}$		40		
Ripple rejection	$V_I = 15\text{ V to }25\text{ V}$, $f = 120\text{ Hz}$		45		dB
Output voltage regulation	$I_O = 1\text{ mA to }100\text{ mA}$		19		mV
	$I_O = 1\text{ mA to }40\text{ mA}$		11		
Output noise voltage	$f = 10\text{ Hz to }100\text{ kHz}$		58		μV
Dropout voltage			1.7		V
Bias current			4.1		mA

[†] Pulse-testing techniques maintain T_J as close to T_A as possible. Thermal effects must be taken into account separately. All characteristics are measured with a 0.33-μF capacitor across the input and a 0.1-μF capacitor across the output.

electrical characteristics at specified virtual junction temperature, $V_I = 14\text{ V}$, $I_O = 40\text{ mA}$, $T_J = 25^\circ\text{C}$ (unless otherwise noted)

PARAMETER	TEST CONDITION [†]	μA78L10Y			UNIT
		MIN	TYP	MAX	
Output voltage			10		V
Input voltage regulation	$V_I = 13\text{ V to }25\text{ V}$		51		mV
	$V_I = 14\text{ V to }25\text{ V}$		42		
Ripple rejection	$V_I = 15\text{ V to }25\text{ V}$, $f = 120\text{ Hz}$		44		dB
Output voltage regulation	$I_O = 1\text{ mA to }100\text{ mA}$		20		mV
	$I_O = 1\text{ mA to }40\text{ mA}$		11		
Output noise voltage	$f = 10\text{ Hz to }100\text{ kHz}$		62		μV
Dropout voltage			1.7		V
Bias current			4.2		mA

[†] Pulse-testing techniques maintain T_J as close to T_A as possible. Thermal effects must be taken into account separately. All characteristics are measured with a 0.33-μF capacitor across the input and a 0.1-μF capacitor across the output.



μA78L00 SERIES POSITIVE-VOLTAGE REGULATORS

SLVS010I – JANUARY 1976 – REVISED JULY 1999

electrical characteristics at specified virtual junction temperature, $V_I = 19\text{ V}$, $I_O = 40\text{ mA}$, $T_J = 25^\circ\text{C}$ (unless otherwise noted)

PARAMETER	TEST CONDITIONS†	μA78L12Y			UNIT
		MIN	TYP	MAX	
Output voltage			12		V
Input voltage regulation	$V_I = 14.5\text{ V to }27\text{ V}$		55		mV
	$V_I = 16\text{ V to }27\text{ V}$		49		
Ripple rejection	$V_I = 15\text{ V to }25\text{ V}$, $f = 120\text{ Hz}$		42		dB
Output voltage regulation	$I_O = 1\text{ mA to }100\text{ mA}$		22		mV
	$I_O = 1\text{ mA to }40\text{ mA}$		13		
Output noise voltage	$f = 10\text{ Hz to }100\text{ kHz}$		70		μV
Dropout voltage			1.7		V
Bias current			4.3		mA

† Pulse-testing techniques maintain T_J as close to T_A as possible. Thermal effects must be taken into account separately. All characteristics are measured with a 0.33-μF capacitor across the input and a 0.1-μF capacitor across the output.

electrical characteristics at specified virtual junction temperature, $V_I = 23\text{ V}$, $I_O = 40\text{ mA}$, $T_J = 25^\circ\text{C}$ (unless otherwise noted)

PARAMETER	TEST CONDITIONS†	μA78L15Y			UNIT
		MIN	TYP	MAX	
Output voltage			15		V
Input voltage regulation	$V_I = 17.5\text{ V to }30\text{ V}$		65		mV
	$V_I = 20\text{ V to }30\text{ V}$		58		
Ripple rejection	$V_I = 18.5\text{ V to }28.5\text{ V}$, $f = 120\text{ Hz}$		39		dB
Output voltage regulation	$I_O = 1\text{ mA to }100\text{ mA}$		25		mV
	$I_O = 1\text{ mA to }40\text{ mA}$		15		
Output noise voltage	$f = 10\text{ Hz to }100\text{ kHz}$		82		μV
Dropout voltage			1.7		V
Bias current			4.6		mA

† Pulse-testing techniques maintain T_J as close to T_A as possible. Thermal effects must be taken into account separately. All characteristics are measured with a 0.33-μF capacitor across the input and a 0.1-μF capacitor across the output.



APPLICATION INFORMATION

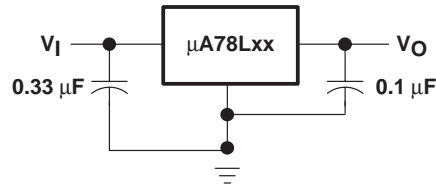

Figure 1. Fixed-Output Regulator

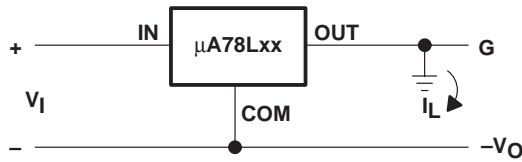

Figure 2. Positive Regulator in Negative Configuration (V_I Must Float)

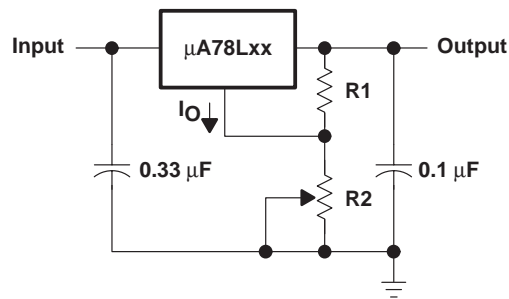
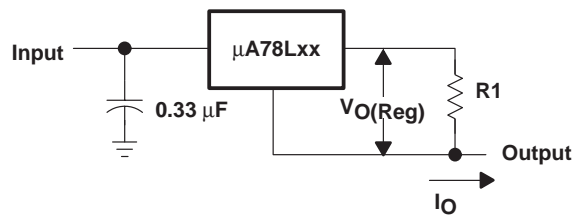

Figure 3. Adjustable-Output Regulator



$$I_O = (V_O/R1) + I_O \text{ Bias Current}$$

Figure 4. Current Regulator

APPLICATION INFORMATION

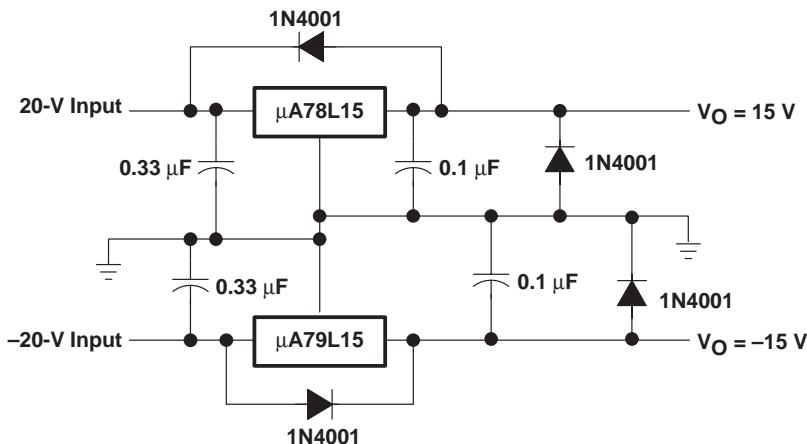

Figure 5. Regulated Dual Supply

operation with a load common to a voltage of opposite polarity

In many cases, a regulator powers a load that is not connected to ground but, instead, is connected to a voltage source of opposite polarity (e.g., operational amplifiers, level-shifting circuits, etc.). In these cases, a clamp diode should be connected to the regulator output as shown in Figure 6. This protects the regulator from output polarity reversals during startup and short-circuit operation.

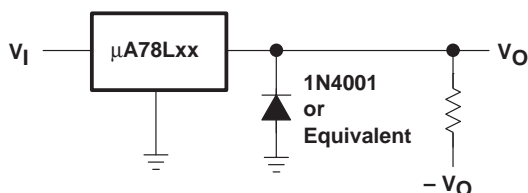

Figure 6. Output Polarity-Reversal-Protection Circuit

reverse-bias protection

Occasionally, the input voltage to the regulator can collapse faster than the output voltage. This can occur, for example, when the input supply is crowbarred during an output overvoltage condition. If the output voltage is greater than approximately 7 V, the emitter-base junction of the series-pass element (internal or external) could break down and be damaged. To prevent this, a diode shunt can be employed as shown in Figure 7.

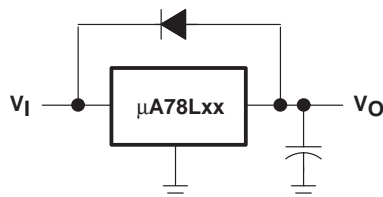

Figure 7. Reverse-Bias-Protection Circuit

IMPORTANT NOTICE

Texas Instruments and its subsidiaries (TI) reserve the right to make changes to their products or to discontinue any product or service without notice, and advise customers to obtain the latest version of relevant information to verify, before placing orders, that information being relied on is current and complete. All products are sold subject to the terms and conditions of sale supplied at the time of order acknowledgement, including those pertaining to warranty, patent infringement, and limitation of liability.

TI warrants performance of its semiconductor products to the specifications applicable at the time of sale in accordance with TI's standard warranty. Testing and other quality control techniques are utilized to the extent TI deems necessary to support this warranty. Specific testing of all parameters of each device is not necessarily performed, except those mandated by government requirements.

CERTAIN APPLICATIONS USING SEMICONDUCTOR PRODUCTS MAY INVOLVE POTENTIAL RISKS OF DEATH, PERSONAL INJURY, OR SEVERE PROPERTY OR ENVIRONMENTAL DAMAGE ("CRITICAL APPLICATIONS"). TI SEMICONDUCTOR PRODUCTS ARE NOT DESIGNED, AUTHORIZED, OR WARRANTED TO BE SUITABLE FOR USE IN LIFE-SUPPORT DEVICES OR SYSTEMS OR OTHER CRITICAL APPLICATIONS. INCLUSION OF TI PRODUCTS IN SUCH APPLICATIONS IS UNDERSTOOD TO BE FULLY AT THE CUSTOMER'S RISK.

In order to minimize risks associated with the customer's applications, adequate design and operating safeguards must be provided by the customer to minimize inherent or procedural hazards.

TI assumes no liability for applications assistance or customer product design. TI does not warrant or represent that any license, either express or implied, is granted under any patent right, copyright, mask work right, or other intellectual property right of TI covering or relating to any combination, machine, or process in which such semiconductor products or services might be or are used. TI's publication of information regarding any third party's products or services does not constitute TI's approval, warranty or endorsement thereof.