

Data sheet | Item number: 2604-3508

PCB terminal block; lever; 4 mm²; Pin spacing 11.5 mm; 8-pole; Push-in
CAGE CLAMP®; 4,00 mm²; gray

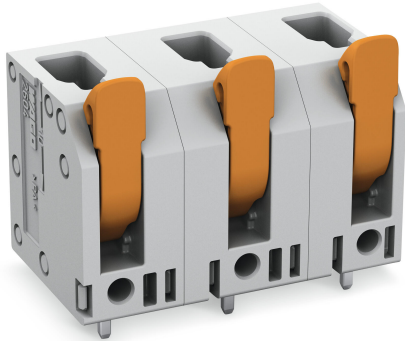

www.wago.com/2604-3508



i Picture differs from the item.

RoHS
Compliant

BOMcheck.net

Color: ■

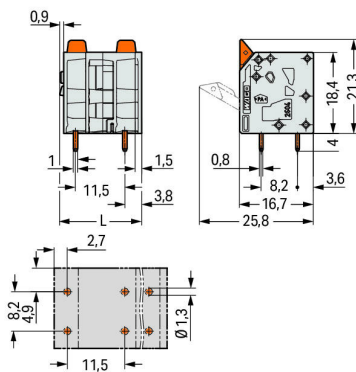
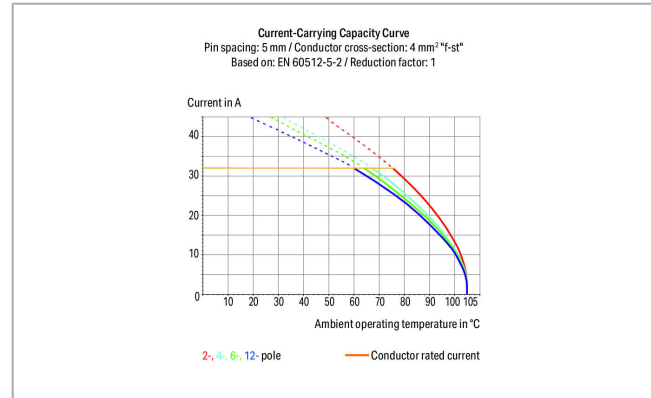

$$L = (\text{pole no.} - 1) \times \text{pin spacing} + 7.4 \text{ mm}$$

Item description

- PCB terminal blocks with levers and Push-in CAGE CLAMP® connection
- Push-in termination of solid and ferruled conductors
- Intuitive and tool-free operation

Subject to changes. Please also observe the further product documentation!

WAGO Kontakttechnik GmbH & Co. KG

Hansastr. 27

32423 Minden

Phone: +49571 887-0 | Fax: +49571 887-169

Email: info.de@wago.com | Web: www.wago.com

Do you have any questions about our products?

We are always happy to take your call at +49 (571) 887-44222.



- Several clamping units can be held open simultaneously – convenient for terminating multi-core cables
- Testing can be performed both parallel and perpendicular to conductor entry

Data

Electrical data

Ratings per IEC/EN

Ratings per	IEC/EN 60664-1
Nominal voltage (III/3)	1000 V
Rated surge voltage (III/3)	8 kV
Rated voltage (III/2)	1000 V
Rated surge voltage (III/2)	8 kV
Nominal voltage (II/2)	1000 V
Rated surge voltage (II/2)	8 kV
Rated current	32 A
Legend (ratings)	(III / 2) $\hat{=}$ Overvoltage category III / Pollution degree 2

Ratings per UL

Approvals per	UL 1059
Rated voltage UL (Use Group B)	600 V
Rated current UL (Use Group B)	20 A
Rated voltage UL (Use Group C)	600 V
Rated current UL (Use Group C)	20 A

Ratings per CSA

Approvals per	CSA
Rated voltage CSA (Use Group B)	600 V
Rated current CSA (Use Group B)	20 A
Rated voltage CSA (Use Group C)	300 V
Rated current CSA (Use Group C)	20 A

Connection data

Connection technology	Push-in CAGE CLAMP®
Actuation type	Lever
Solid conductor	0.2 ... 4 mm ² / 24 ... 12 AWG
Fine-stranded conductor	0.2 ... 4 mm ² / 24 ... 12 AWG

Subject to changes. Please also observe the further product documentation!



Fine-stranded conductor; with insulated ferrule	0.25 ... 2.5 mm ²
Fine-stranded conductor; with uninsulated ferrule	0.25 ... 2.5 mm ²
Fine-stranded conductor; with twin ferrule	0.25 ... 1.5 mm ²
Strip length	9 ... 11 mm / 0.35 ... 0.43 inch
Conductor connection direction to PCB	90°
Pole No.	8
Total number of connection points	8
Total number of potentials	8
Number of connection types	1
Number of levels	1

Physical data

Pin spacing	11.5 mm / 0.453 inch
Width	87.9 mm / 3.461 inch
Height	25.3 mm / 0.996 inch
Height from the surface	21.3 mm / 0.839 inch
Depth	16.7 mm / 0.657 inch
Solder pin length	4 mm
Solder pin dimensions	0.8 x 1 mm
Drilled hole diameter with tolerance	1.3 ^(+0.1) mm

PCB contact

PCB Contact	THT
Solder pin arrangement	over the entire terminal strip (in-line)
Number of solder pins per potential	2

Material data

Color	gray
Material group	I
Insulation material	Polyamide (PA66)
Flammability class per UL94	V0
Clamping spring material	Chrome nickel spring steel (CrNi)
Contact material	Electrolytic copper (E _{Cu})
Contact plating	tin-plated
Color of actuator	orange
Weight	21 g

Subject to changes. Please also observe the further product documentation!

Environmental requirements



Limit temperature range -60 ... +105 °C

Commercial data

Packaging type	BOX
Country of origin	DE
GTIN	4055143565042
Customs tariff number	85369010000

Approvals / Certificates

Country specific Approvals



Logo	Approval	Additional Approval Text	Certificate name
	CB DEKRA Certification B.V.	EN 60947-7-4	NL-47057
	CSA DEKRA Certification B.V.	C22.2 No. 158	70117145
	KEMA/KEUR DEKRA Certification B.V.	EN 60947-7-4	71-100535

UL-Approvals





Logo	Approval	Additional Approval Text	Certificate name
	cURus Underwriters Laboratories Inc.	UL 1059	E45172

Compatible products

ferrule

	Item no.: 216-106 Ferrule; Sleeve for 2.5 mm ² / AWG 14; uninsulated; electro-tin plated; silver-colored	www.wago.com/216-106
	Item no.: 216-241 Ferrule; Sleeve for 0.5 mm ² / 20 AWG; insulated; electro-tin plated; electrolytic copper; gastight crimped; acc. to DIN 46228, Part 4/09.90; white	www.wago.com/216-241

Subject to changes. Please also observe the further product documentation!

	Item no.: 216-242 Ferrule; Sleeve for 0.75 mm ² / 18 AWG; insulated; electro-tin plated; electrolytic copper; gastight crimped; acc. to DIN 46228, Part 4/09.90; gray	www.wago.com/216-242
	Item no.: 216-243 Ferrule; Sleeve for 1 mm ² / AWG 18; insulated; electro-tin plated; electrolytic copper; gastight crimped; acc. to DIN 46228, Part 4/09.90; red	www.wago.com/216-243
	Item no.: 216-244 Ferrule; Sleeve for 1.5 mm ² / AWG 16; insulated; electro-tin plated; electrolytic copper; gastight crimped; acc. to DIN 46228, Part 4/09.90; black	www.wago.com/216-244
	Item no.: 216-246 Ferrule; Sleeve for 2.5 mm ² / AWG 14; insulated; electro-tin plated; electrolytic copper; gastight crimped; acc. to DIN 46228, Part 4/09.90; blue	www.wago.com/216-246

Downloads

Documentation

Additional Information

Technical explanations	3. 4. 2019	pdf 2.0 MB	Download
------------------------	------------	---------------	----------

CAD/CAE-Data

CAD data

2D/3D Models 2604-3508	URL	Download
------------------------	-----	----------

PCB Design

Symbol and Footprint 2604-3508	URL	Download
--------------------------------	-----	----------

CAX data for your PCB design, consisting of "schematic symbols and PCB footprints", allow easy integration of the WAGO component into your development environment.

Supported formats:

- Accel EDA 14 & 15
- Altium 6 to current version
- Cadence Allegro
- DesignSpark
- Eagle Libraries
- KiCad
- Mentor Graphics BoardStation
- Mentor Graphics Design Architect
- Mentor Graphics Design Expedition 99 and 2000

Subject to changes. Please also observe the further product documentation!



- OrCAD 9.X PCB and Capture
- PADS PowerPCB 3, 3.5, 4.X, and 5.X
- PADS PowerPCB and PowerLogic 3.0
- PCAD 2000, 2001, 2002, 2004, and 2006
- Pulsonix 8.5 or newer
- STL
- 3D STEP
- TARGET 3001!
- View Logic ViewDraw
- Quadcept
- Zuken CadStar 3 and 4
- Zuken CR-5000 and CR-8000

PCB Component Libraries (EDA), PCB CAD Library Ultra Librarian

CAE data

ZUKEN Portal 2604-3508	URL	Download
------------------------	---------------------	--------------------------

Environmental Product Compliance

Compliance Search

Environmental Product Compliance 2604-3508 PCB terminal block; lever; 4 mm ² ; Pin spacing 11.5 mm; 8-pole; Push-in CAGE CLAMP®; 4,00 mm ² ; gray	URL	Download
--	---------------------	--------------------------

Installation Notes

Subject to changes. Please also observe the further product documentation!