

# Data Sheet | Item Number: 231-102/124-000

1-conductor female connector; CAGE CLAMP®; 2.5 mm<sup>2</sup>; Pin spacing 5 mm; 2-pole; Snap-in flange; 2,50 mm<sup>2</sup>; gray

<https://www.wago.com/231-102/124-000>



Color: ■ gray

Similar to illustration

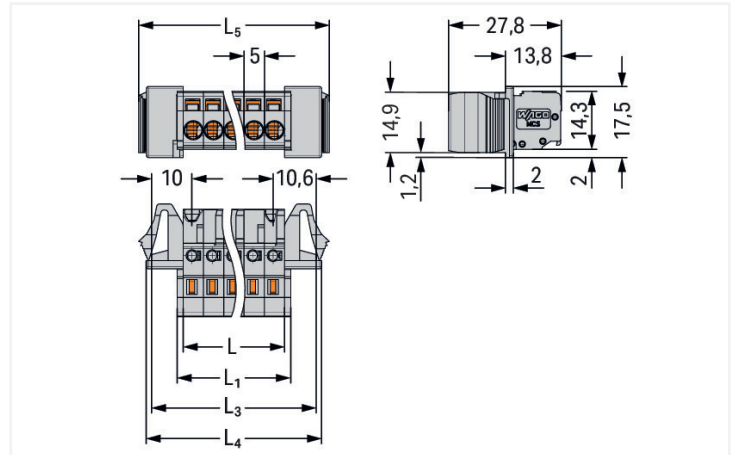

L = pole no. x pin spacing  
L1 = (pole no. x pin spacing) + 3 mm  
L3 = (pole no. x pin spacing) + 15.6 mm  
L4 = (pole no. x pin spacing) + 18.2 mm  
L5 = (pole no. x pin spacing) + 22 mm  
2- to 5-pole female connectors with reinforcing strips

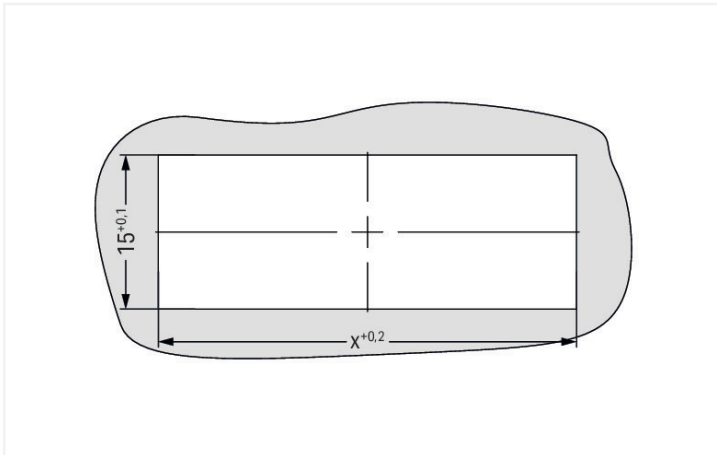

X = (pole no. x pin spacing) + 15.8 mm  
for plate thickness 0.5 ... 3 mm

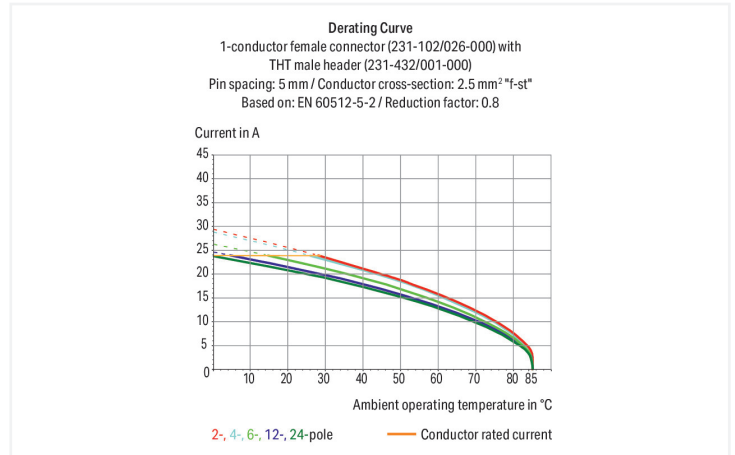

- Universal connection for all conductor types
- Easy cable pre-assembly and on-unit wiring via vertical and horizontal CAGE CLAMP® actuation
- Integrated test ports
- With coding fingers

## Notes

Safety information

The MCS – MULTI CONNECTION SYSTEM includes connectors without breaking capacity in accordance with DIN EN 61984. When used as intended, these connectors must not be connected/disconnected when live or under load. When used as intended, these connectors must not be connected/disconnected when live or under load. The circuit design should ensure header pins, which can be touched, are not live when unmated.

Variants:

Gold-plated or partially gold-plated contact surfaces  
Other versions (or variants) can be requested from WAGO Sales or configured at <https://configurator.wago.com/>.

## Electrical data

### Ratings per IEC/EN

Ratings per	IEC/EN 60664-1
Nominal voltage (III/3)	320 V
Rated impulse voltage (III/3)	4 kV
Rated voltage (III/2)	320 V
Rated impulse voltage (III/2)	4 kV
Nominal voltage (II/2)	630 V
Rated surge voltage (II/2)	4 kV
Rated current	16 A
Legend (ratings)	(III / 2) ≙ Overvoltage category III / Pollution degree 2

### Ratings per UL 1059

Approvals per	UL 1059
Rated voltage UL (Use Group B)	300 V
Rated current UL (Use Group B)	15 A
Rated voltage UL (Use Group D)	300 V
Rated current UL (Use Group D)	10 A

### Ratings per UL 1977

Rated voltage (UL 1977)	600 V
Rated current UL 1977	15 A

### Ratings per CSA

Approvals per	CSA
Rated voltage CSA (Use Group B)	300 V
Rated current CSA (Use Group B)	15 A
Rated voltage CSA (Use Group D)	300 V
Rated current CSA (Use Group D)	10 A

### Connection data

Connection points	2
Total number of potentials	2
Number of connection types	1
Number of levels	1

### Connection 1

Connection technology	CAGE CLAMP®
Actuation type	Operating tool
Actuation direction 1	Operation parallel to conductor entry
Actuation direction 2	Operation perpendicular to conductor entry
Solid conductor	0.08 ... 2.5 mm <sup>2</sup> / 28 ... 12 AWG
Fine-stranded conductor	0.08 ... 2.5 mm <sup>2</sup> / 28 ... 12 AWG
Fine-stranded conductor; with insulated ferrule	0.25 ... 1.5 mm <sup>2</sup>
Fine-stranded conductor; with uninsulated ferrule	0.25 ... 2.5 mm <sup>2</sup>
Strip length	8 ... 9 mm / 0.31 ... 0.35 inches
Pole number	2
Conductor entry direction to mating direction	0°

### Physical data

Pin spacing	5 mm / 0.197 inches
Width	32 mm / 1.26 inches
Height	14.3 mm / 0.563 inches
Depth	26.45 mm / 1.041 inches

### Mechanical data

Variable coding	Yes
Housing sheet thickness	0.5 ... 3 mm / 0.02 ... 0.118 inches
Mounting type	Snap-in flange Feed-through mounting
Anti-rotation protection	Yes

### Plug-in connection

Contact type (pluggable connector)	Female connector/socket
Connector (connection type)	for conductor
Mismating protection	No

### Material data

Note (material data)	<a href="#">Information on material specifications can be found here</a>
Color	gray
Material group	I
Insulation material	Polyamide (PA66)
Flammability class per UL94	V0
Clamping spring material	Chrome-nickel spring steel (CrNi)
Contact material	Copper alloy
Contact plating	Tin
Fire load	0.183 MJ
Weight	6.4 g

### Environmental requirements

Limit temperature range	-60 ... +85 °C
Processing temperature	-35 ... +60 °C

### Commercial data

PU (SPU)	100 pcs
Country of origin	DE
GTIN	4066966277807
Customs tariff number	85366990990

### Environmental Product Compliance

RoHS Compliance Status	Compliant, No Exemption
------------------------	-------------------------

### Approvals / Certificates

#### General approvals



Approval	Standard	Certificate Name
CB DEKRA Certification B.V.	IEC 61984	NL-39756/A1
CSA DEKRA Certification B.V.	C22.2	1466354

### Downloads

## Environmental Product Compliance

### Compliance Search

Environmental Product  
Compliance  
231-102/124-000



## Documentation

### Additional Information

Technical Section

03.04.2019

pdf

1949.09 KB



## 1 Compatible Products

### 1.1 System counterpart

#### 1.1.1 Male connector/plug



**Item No.: 231-602**

1-conductor male connector; CAGE CLAMP®; 2.5 mm<sup>2</sup>; Pin spacing 5 mm; 2-pole; 2,50 mm<sup>2</sup>; gray



**Item No.: 231-432/001-000**

THT male header; 1.0 x 1.0 mm solder pin; angled; Pin spacing 5 mm; 2-pole; gray



**Item No.: 231-132/001-000**

THT male header; 1.0 x 1.0 mm solder pin; straight; Pin spacing 5 mm; 2-pole; gray

### 1.2 Optional Accessories

#### 1.2.1 Cover

##### 1.2.1.1 Cover



**Item No.: 231-668**

Lockout caps; for covering unused clamping units; gray

#### 1.2.2 Ferrule

##### 1.2.2.1 Ferrule



**Item No.: 216-301**

Ferrule; Sleeve for 0.25 mm<sup>2</sup> / AWG 24; insulated; electro-tin plated; yellow



**Item No.: 216-321**

Ferrule; Sleeve for 0.25 mm<sup>2</sup> / AWG 24; insulated; electro-tin plated; yellow



**Item No.: 216-151**

Ferrule; Sleeve for 0.25 mm<sup>2</sup> / AWG 24; uninsulated; electro-tin plated



**Item No.: 216-131**

Ferrule; Sleeve for 0.25 mm<sup>2</sup> / AWG 24; uninsulated; electro-tin plated; silver-colored



**Item No.: 216-302**

Ferrule; Sleeve for 0.34 mm<sup>2</sup> / 22 AWG; insulated; electro-tin plated; light turquoise



**Item No.: 216-322**

Ferrule; Sleeve for 0.34 mm<sup>2</sup> / 22 AWG; insulated; electro-tin plated; light turquoise



**Item No.: 216-132**





























Ferrule; Sleeve for 0.34 mm<sup>2</sup> / AWG 24; uninsulated; electro-tin plated



**Item No.: 216-152**

Ferrule; Sleeve for 0.34 mm<sup>2</sup> / AWG 24; uninsulated; electro-tin plated

1.2.2.1 Ferrule

 <p><b>Item No.: 216-241</b> Ferrule; Sleeve for 0.5 mm<sup>2</sup> / 20 AWG; insulated; electro-tin plated; electrolytic copper; gastight crimped; acc. to DIN 46228, Part 4/09.90; white</p>	 <p><b>Item No.: 216-201</b> Ferrule; Sleeve for 0.5 mm<sup>2</sup> / 20 AWG; insulated; electro-tin plated; white</p>	 <p><b>Item No.: 216-221</b> Ferrule; Sleeve for 0.5 mm<sup>2</sup> / 20 AWG; insulated; electro-tin plated; white</p>	 <p><b>Item No.: 216-141</b> Ferrule; Sleeve for 0.5 mm<sup>2</sup> / 20 AWG; un-insulated; electro-tin plated; electrolytic copper; gastight crimped; acc. to DIN 46228, Part 1/08.92</p>
 <p><b>Item No.: 216-101</b> Ferrule; Sleeve for 0.5 mm<sup>2</sup> / AWG 22; un-insulated; electro-tin plated; silver-colored</p>	 <p><b>Item No.: 216-121</b> Ferrule; Sleeve for 0.5 mm<sup>2</sup> / AWG 22; un-insulated; electro-tin plated; silver-colored</p>	 <p><b>Item No.: 216-242</b> Ferrule; Sleeve for 0.75 mm<sup>2</sup> / 18 AWG; insulated; electro-tin plated; electrolytic copper; gastight crimped; acc. to DIN 46228, Part 4/09.90; gray</p>	 <p><b>Item No.: 216-262</b> Ferrule; Sleeve for 0.75 mm<sup>2</sup> / 18 AWG; insulated; electro-tin plated; electrolytic copper; gastight crimped; acc. to DIN 46228, Part 4/09.90; gray</p>
 <p><b>Item No.: 216-202</b> Ferrule; Sleeve for 0.75 mm<sup>2</sup> / 18 AWG; insulated; electro-tin plated; gray</p>	 <p><b>Item No.: 216-222</b> Ferrule; Sleeve for 0.75 mm<sup>2</sup> / 18 AWG; insulated; electro-tin plated; gray</p>	 <p><b>Item No.: 216-142</b> Ferrule; Sleeve for 0.75 mm<sup>2</sup> / 18 AWG; un-insulated; electro-tin plated; electrolytic copper; gastight crimped; acc. to DIN 46228, Part 1/08.92</p>	 <p><b>Item No.: 216-102</b> Ferrule; Sleeve for 0.75 mm<sup>2</sup> / AWG 20; un-insulated; electro-tin plated; silver-colored</p>
 <p><b>Item No.: 216-122</b> Ferrule; Sleeve for 0.75 mm<sup>2</sup> / AWG 20; un-insulated; electro-tin plated; silver-colored</p>	 <p><b>Item No.: 216-243</b> Ferrule; Sleeve for 1 mm<sup>2</sup> / AWG 18; insulated; electro-tin plated; electrolytic copper; gastight crimped; acc. to DIN 46228, Part 4/09.90; red</p>	 <p><b>Item No.: 216-263</b> Ferrule; Sleeve for 1 mm<sup>2</sup> / AWG 18; insulated; electro-tin plated; electrolytic copper; gastight crimped; acc. to DIN 46228, Part 4/09.90; red</p>	 <p><b>Item No.: 216-203</b> Ferrule; Sleeve for 1 mm<sup>2</sup> / AWG 18; insulated; electro-tin plated; red</p>
 <p><b>Item No.: 216-223</b> Ferrule; Sleeve for 1 mm<sup>2</sup> / AWG 18; insulated; electro-tin plated; red</p>	 <p><b>Item No.: 216-103</b> Ferrule; Sleeve for 1 mm<sup>2</sup> / AWG 18; un-insulated; electro-tin plated</p>	 <p><b>Item No.: 216-143</b> Ferrule; Sleeve for 1 mm<sup>2</sup> / AWG 18; un-insulated; electro-tin plated; electrolytic copper; gastight crimped; acc. to DIN 46228, Part 1/08.92</p>	 <p><b>Item No.: 216-123</b> Ferrule; Sleeve for 1 mm<sup>2</sup> / AWG 18; un-insulated; electro-tin plated; silver-colored</p>
 <p><b>Item No.: 216-204</b> Ferrule; Sleeve for 1.5 mm<sup>2</sup> / AWG 16; insulated; electro-tin plated; black</p>	 <p><b>Item No.: 216-224</b> Ferrule; Sleeve for 1.5 mm<sup>2</sup> / AWG 16; insulated; electro-tin plated; black</p>	 <p><b>Item No.: 216-244</b> Ferrule; Sleeve for 1.5 mm<sup>2</sup> / AWG 16; insulated; electro-tin plated; electrolytic copper; gastight crimped; acc. to DIN 46228, Part 4/09.90; black</p>	 <p><b>Item No.: 216-264</b> Ferrule; Sleeve for 1.5 mm<sup>2</sup> / AWG 16; insulated; electro-tin plated; electrolytic copper; gastight crimped; acc. to DIN 46228, Part 4/09.90; black</p>
 <p><b>Item No.: 216-284</b> Ferrule; Sleeve for 1.5 mm<sup>2</sup> / AWG 16; insulated; electro-tin plated; electrolytic copper; gastight crimped; acc. to DIN 46228, Part 4/09.90; black</p>	 <p><b>Item No.: 216-124</b> Ferrule; Sleeve for 1.5 mm<sup>2</sup> / AWG 16; un-insulated; electro-tin plated</p>	 <p><b>Item No.: 216-144</b> Ferrule; Sleeve for 1.5 mm<sup>2</sup> / AWG 16; un-insulated; electro-tin plated; electrolytic copper; gastight crimped; acc. to DIN 46228, Part 1/08.92; silver-colored</p>	 <p><b>Item No.: 216-104</b> Ferrule; Sleeve for 1.5 mm<sup>2</sup> / AWG 16; un-insulated; electro-tin plated; silver-colored</p>
 <p><b>Item No.: 216-106</b> Ferrule; Sleeve for 2.5 mm<sup>2</sup> / AWG 14; un-insulated; electro-tin plated; silver-colored</p>			

1.2.3 Insulation stop

### 1.2.3.1 Insulation stop



**Item No.: 231-670**

Insulation stop; 0.08-0.2 mm<sup>2</sup> / 0.2 mm<sup>2</sup> "s"; white



**Item No.: 231-671**

Insulation stop; 0.25 - 0.5 mm<sup>2</sup>; light gray



**Item No.: 231-672**

Insulation stop; 0.75 - 1 mm<sup>2</sup>; dark gray

### 1.2.4 Jumper

#### 1.2.4.1 Jumper



**Item No.: 231-910**

Jumper; for conductor entry; 10-way; insulated; gray



**Item No.: 231-902**

Jumper; for conductor entry; 2-way; insulated; gray



**Item No.: 231-903**

Jumper; for conductor entry; 3-way; insulated; gray



**Item No.: 231-905**

Jumper; for conductor entry; 5-way; insulated; gray



**Item No.: 231-907**

Jumper; for conductor entry; 7-way; insulated; gray

### 1.2.5 Marking

#### 1.2.5.1 Marking strip



**Item No.: 210-331/500-103**

Marking strips; as a DIN A4 sheet; MARKED; 1-12 (300x); Height of marker strip: 2.3 mm/0.091 in; Strip length 182 mm; Horizontal marking; Self-adhesive; white



**Item No.: 210-332/500-202**

Marking strips; as a DIN A4 sheet; MARKED; 1-16 (160x); Height of marker strip: 3 mm; Strip length 182 mm; Horizontal marking; Self-adhesive; white



**Item No.: 210-332/500-205**

Marking strips; as a DIN A4 sheet; MARKED; 1-32 (80x); Height of marker strip: 3 mm; Strip length 182 mm; Horizontal marking; Self-adhesive; white



**Item No.: 210-331/500-104**

Marking strips; as a DIN A4 sheet; MARKED; 13-24 (300x); Height of marker strip: 2.3 mm/0.091 in; Strip length 182 mm; Horizontal marking; Self-adhesive; white



**Item No.: 210-332/500-204**

Marking strips; as a DIN A4 sheet; MARKED; 17-32 (160x); Height of marker strip: 3 mm; Strip length 182 mm; Horizontal marking; Self-adhesive; white



**Item No.: 210-332/500-206**

Marking strips; as a DIN A4 sheet; MARKED; 33-48 (160x); Height of marker strip: 3 mm; Strip length 182 mm; Horizontal marking; Self-adhesive; white

### 1.2.6 Strain relief

#### 1.2.6.1 Strain relief housing



**Item No.: 232-602**

Strain relief housing; for female and male connectors; 2 parts; Pin spacing 5 mm; 2-pole; gray

### 1.2.7 Test and measurement

### 1.2.7.1 Testing accessories



**Item No.: 210-136**

Test plug; 2 mm Ø; with 500 mm cable; red

**Item No.: 231-661**

Test plugs for female connectors; for 5 mm and 5.08 mm pin spacing; 2,50 mm<sup>2</sup>; light gray

### 1.2.8 Tool

#### 1.2.8.1 Operating tool



**Item No.: 231-231**

Combination operating tool; red



**Item No.: 209-132**

Operating tool; for connecting comb-style jumper bar; made of insulating material; 2-way; natural



**Item No.: 280-440**

Operating tool; made of insulating material; 10-way



**Item No.: 209-130**

Operating tool; made of insulating material; 1-way; for 264 Series (1-1/2-way), 280, 281 Series (up to 3-way); natural



**Item No.: 231-291**

Operating tool; made of insulating material; 1-way; loose; red



**Item No.: 231-131**

Operating tool; made of insulating material; 1-way; loose; white



**Item No.: 280-432**

Operating tool; made of insulating material; 2-way; white



**Item No.: 280-433**

Operating tool; made of insulating material; 3-way



**Item No.: 280-434**

Operating tool; made of insulating material; 4-way



**Item No.: 280-435**

Operating tool; made of insulating material; 5-way; gray



**Item No.: 280-436**

Operating tool; made of insulating material; 6-way



**Item No.: 280-437**

Operating tool; made of insulating material; 7-way



**Item No.: 280-438**

Operating tool; made of insulating material; 8-way



**Item No.: 231-159**

Operating tool; natural

### Installation Notes

#### Conductor termination

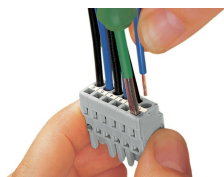

Inserting a conductor via 3.5 mm screwdriver – CAGE CLAMP® actuation parallel to conductor entry.

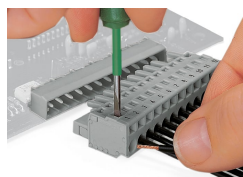

Inserting a conductor via 3.5 mm screwdriver – CAGE CLAMP® actuation perpendicular to conductor entry.

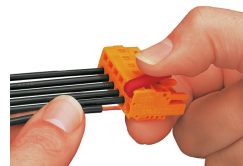

Inserting a conductor into CAGE CLAMP® unit via operating tool (231-291).



Inserting a conductor via operating tool.

### Coding



Coding a female connector by removing coding finger(s).

## Testing

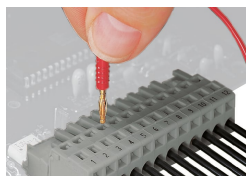

Testing – female connector with CAGE CLAMP®  
Integrated test ports for testing perpendicular to conductor entry via 2 or 2.3 mm Ø test plug

## Installation

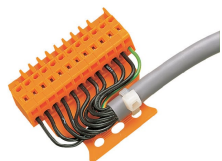

Male connector with strain relief plate



Strain relief housing shown with a male connector equipped with CAGE CLAMP®

## Marking

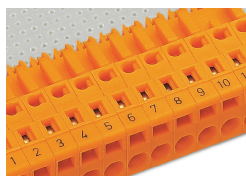

Labeling via direct marking or self-adhesive strips.