

# Data sheet | Item number: 2606-1102/020-016

PCB terminal block; lever; 6 mm<sup>2</sup>; Pin spacing 7.5 mm; 2-pole; Push-in CAGE CLAMP®; 6,00 mm<sup>2</sup>; green-yellow

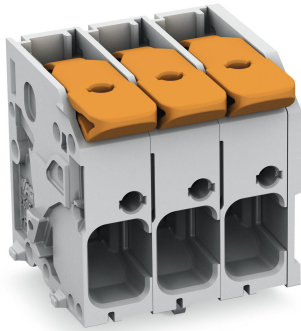

[www.wago.com/2606-1102/020-016](http://www.wago.com/2606-1102/020-016)



**i** Picture differs from the item.

RoHS  Compliant

BOMcheck.net

Color:

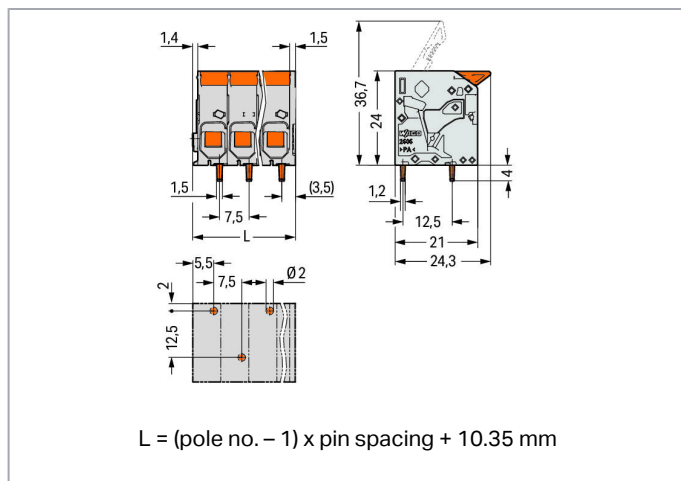
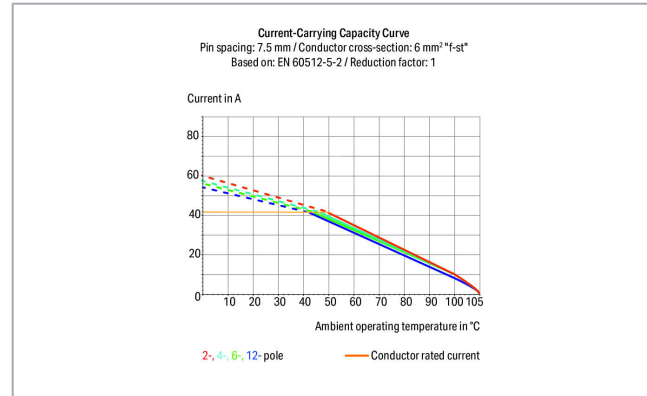

## Item description

- PCB terminal blocks with levers and Push-in CAGE CLAMP® connection
- Push-in termination of solid and ferruled conductors
- Intuitive and tool-free operation

Subject to changes. Please also observe the further product documentation!

WAGO Kontakttechnik GmbH & Co. KG  
Hansastr. 27  
32423 Minden  
Phone: +49571 887-0 | Fax: +49571 887-169  
Email: [info.de@wago.com](mailto:info.de@wago.com) | Web: [www.wago.com](http://www.wago.com)

Do you have any questions about our products?  
We are always happy to take your call at +49 (571) 887-44222.



- Several clamping units can be held open simultaneously – convenient for terminating multi-core cables
- Testing can be performed both parallel and perpendicular to conductor entry

## Data

### Electrical data

#### Ratings per IEC/EN

Ratings per	IEC/EN 60664-1
Nominal voltage (III/3)	800 V
Rated surge voltage (III/3)	8 kV
Rated voltage (III/2)	1000 V
Rated surge voltage (III/2)	8 kV
Nominal voltage (II/2)	1000 V
Rated surge voltage (II/2)	8 kV
Rated current	41 A
Legend (ratings)	(III / 2) $\hat{=}$ Overvoltage category III / Pollution degree 2

#### Ratings per UL

Approvals per	UL 1059
Rated voltage UL (Use Group B)	600 V
Rated current UL (Use Group B)	31 A
Rated voltage UL (Use Group C)	600 V
Rated current UL (Use Group C)	31 A

#### Ratings per CSA

Approvals per	CSA
Rated voltage CSA (Use Group B)	600 V
Rated current CSA (Use Group B)	31 A
Rated voltage CSA (Use Group C)	600 V
Rated current CSA (Use Group C)	31 A

### Connection data

Connection technology	Push-in CAGE CLAMP®
Actuation type	Lever
Solid conductor	0.2 ... 10 mm <sup>2</sup> / 24 ... 8 AWG
Fine-stranded conductor	0.2 ... 10 mm <sup>2</sup> / 24 ... 8 AWG

Subject to changes. Please also observe the further product documentation!



Fine-stranded conductor; with insulated ferrule	0.25 ... 6 mm <sup>2</sup>
Fine-stranded conductor; with uninsulated ferrule	0.25 ... 6 mm <sup>2</sup>
Fine-stranded conductor; with twin ferrule	0.25 ... 2.5 mm <sup>2</sup>
Strip length	11 ... 13 mm / 0.43 ... 0.51 inch
Conductor connection direction to PCB	0°
Total number of connection points	2
Total number of potentials	2
Number of connection types	1
Number of levels	1

### Physical data

Pin spacing	7.5 mm / 0.295 inch
Width	17.85 mm / 0.703 inch
Height	28 mm / 1.102 inch
Height from the surface	24 mm / 0.945 inch
Depth	24.3 mm / 0.957 inch
Solder pin length	4 mm
Solder pin dimensions	1.5 x 1.2 mm
Drilled hole diameter with tolerance	2 <sup>(+0.1)</sup> mm

### PCB contact

PCB Contact	THT
Solder pin arrangement	over the entire terminal strip (staggered)
Number of solder pins per potential	1

### Material data

Color	green-yellow
Material group	I
Insulation material	Polyamide (PA66)
Flammability class per UL94	V0
Clamping spring material	Chrome nickel spring steel (CrNi)
Contact material	Electrolytic copper (E <sub>Cu</sub> )
Contact plating	tin-plated
Fire load	0.017 MJ
Color of actuator	orange
Weight	8.2 g

Subject to changes. Please also observe the further product documentation!

## Environmental requirements

Limit temperature range -60 ... +105 °C

## Commercial data

Packaging type	BOX
Country of origin	PL
GTIN	4055143942003
Customs tariff number	85369010000







## Approvals / Certificates

### UL-Approvals

Logo	Approval	Additional Approval Text	Certificate name
	UL Underwriters Laboratories Inc.	UL 1059	E45172

## Compatible products

### ferrule

	<b>Item no.: 216-108</b> Ferrule; Sleeve for 6 mm <sup>2</sup> / AWG 10; uninsulated; electro-tin plated; silver-colored	<a href="http://www.wago.com/216-108">www.wago.com/216-108</a>
	<b>Item no.: 216-208</b> Ferrule; Sleeve for 6 mm <sup>2</sup> / AWG 10; insulated; electro-tin plated; electrolytic copper; gastight crimped; acc. to DIN 46228, Part 4/09.90; yellow	<a href="http://www.wago.com/216-208">www.wago.com/216-208</a>
	<b>Item no.: 216-263</b> Ferrule; Sleeve for 1 mm <sup>2</sup> / AWG 18; insulated; electro-tin plated; electrolytic copper; gastight crimped; acc. to DIN 46228, Part 4/09.90; red	<a href="http://www.wago.com/216-263">www.wago.com/216-263</a>
	<b>Item no.: 216-264</b> Ferrule; Sleeve for 1.5 mm <sup>2</sup> / AWG 16; insulated; electro-tin plated; electrolytic copper; gastight crimped; acc. to DIN 46228, Part 4/09.90; black	<a href="http://www.wago.com/216-264">www.wago.com/216-264</a>
	<b>Item no.: 216-266</b> Ferrule; Sleeve for 2.5 mm <sup>2</sup> / AWG 14; insulated; electro-tin plated; electrolytic copper; gastight crimped; acc. to DIN 46228, Part 4/09.90; blue	<a href="http://www.wago.com/216-266">www.wago.com/216-266</a>
	<b>Item no.: 216-267</b> Ferrule; Sleeve for 4 mm <sup>2</sup> / AWG 12; insulated; electro-tin plated; electrolytic copper; gastight crimped; acc. to DIN 46228, Part 4/09.90; gray	<a href="http://www.wago.com/216-267">www.wago.com/216-267</a>

Subject to changes. Please also observe the further product documentation!



## Downloads

### Documentation

#### Additional Information

Technical explanations	3. 4. 2019	pdf 2.0 MB	Download
------------------------	------------	---------------	----------

## CAD/CAE-Data

### PCB Design

Symbol and Footprint 2606-1102/020-016	URL	Download
--	-----	----------

CAX data for your PCB design, consisting of "schematic symbols and PCB footprints", allow easy integration of the WAGO component into your development environment.

### Supported formats:

- Accel EDA 14 & 15
- Altium 6 to current version
- Cadence Allegro
- DesignSpark
- Eagle Libraries
- KiCad
- Mentor Graphics BoardStation
- Mentor Graphics Design Architect
- Mentor Graphics Design Expedition 99 and 2000
- OrCAD 9.X PCB and Capture
- PADS PowerPCB 3, 3.5, 4.X, and 5.X
- PADS PowerPCB and PowerLogic 3.0
- PCAD 2000, 2001, 2002, 2004, and 2006
- Pulsonix 8.5 or newer
- STL
- 3D STEP
- TARGET 3001!
- View Logic ViewDraw
- Quadcept
- Zuken CadStar 3 and 4
- Zuken CR-5000 and CR-8000

PCB Component Libraries (EDA), PCB CAD Library Ultra Librarian

Subject to changes. Please also observe the further product documentation!

WAGO Kontakttechnik GmbH & Co. KG  
Hansastr. 27  
32423 Minden  
Phone: +49571 887-0 | Fax: +49571 887-169  
Email: [info.de@wago.com](mailto:info.de@wago.com) | Web: [www.wago.com](http://www.wago.com)

Do you have any questions about our products?  
We are always happy to take your call at +49 (571) 887-44222.



#### CAE data

ZUKEN Portal 2606-1102/020-016	<a href="#">URL</a>	<a href="#">Download</a>
--------------------------------	---------------------	--------------------------

---

#### CAD data

2D/3D Models 2606-1102/020-016	<a href="#">URL</a>	<a href="#">Download</a>
--------------------------------	---------------------	--------------------------

---

### Environmental Product Compliance

#### Compliance Search

Environmental Product Compliance 2606-1102/020-016	<a href="#">URL</a>	<a href="#">Download</a>
--	---------------------	--------------------------

PCB terminal block; lever; 6 mm<sup>2</sup>; Pin spacing 7.5 mm; 2-pole; Push-in CAGE CLAMP®; 6,00 mm<sup>2</sup>; green-yellow

---

### Installation Notes

Subject to changes. Please also observe the further product documentation!

---

WAGO Kontakttechnik GmbH & Co. KG  
Hansastr. 27  
32423 Minden  
Phone: +49571 887-0 | Fax: +49571 887-169  
Email: [info.de@wago.com](mailto:info.de@wago.com) | Web: [www.wago.com](http://www.wago.com)

Do you have any questions about our products?  
We are always happy to take your call at +49 (571) 887-44222.