

THIS DOCUMENT IS THE PROPERTY OF  
KEYSTONE ELECTRONICS CORP. AND  
SHALL NOT BE REPRODUCED, DISTRIBUTED  
OR USED AS A BASIS FOR MANUFACTURE  
WITHOUT PRIOR WRITTEN PERMISSION  
FROM KEYSTONE ELECTRONICS CORP.

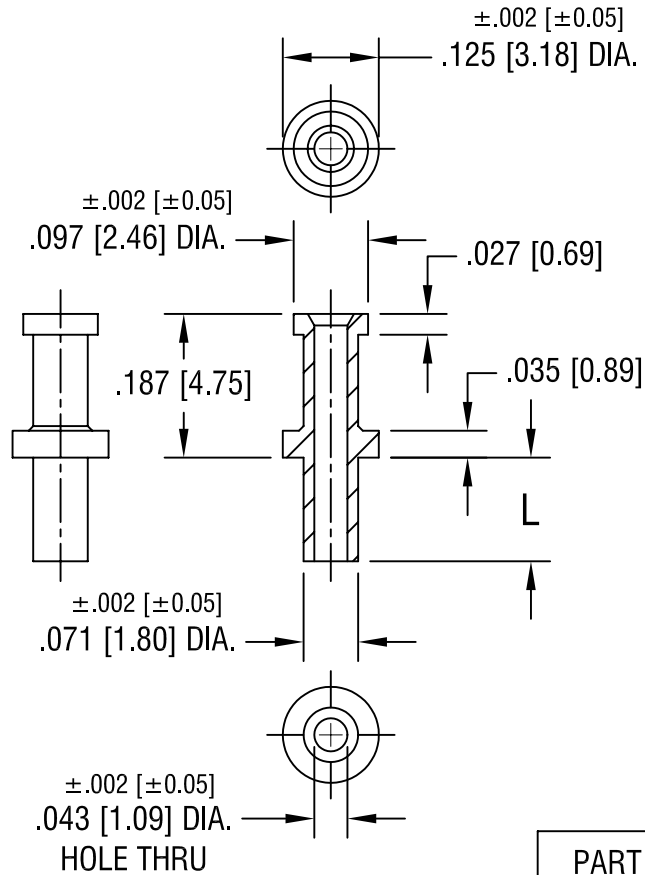

PART NO.	'L' DIM.
1559-1	.062 [1.57]
1559-2	.093 [2.36]
1559-3	.125 [3.18]
1559-4	.156 [3.96]

**KEYSTONE ELECTRONICS CORP.**

ASTORIA, N.Y. 11105-2017

PART NAME

TERMINAL

MATERIAL

BRASS

FINISH

TIN PLATE

DRN BY

BOONE

DATE

6.10.02

APPD

LN

SCALE

4X

TOLERANCES

INCH [MM]

DECIMAL  $\pm .005$  [ $\pm 0.15$ ]

ANGULAR  $\pm 1^\circ$

UNLESS OTHERWISE SPECIFIED

CODE

C/M

DWG NO.

1559-

DATE

DESCRIPTION

REV.