

Data sheet | Item number: 765-4101/100-000

8-Port-IO Link Master Class A; Profinet; DC 24 V / 2.0 A; 8xM12 connection;
WideLine



www.wago.com/765-4101/100-000



RoHS
Compliant ✓

BOMcheck.net

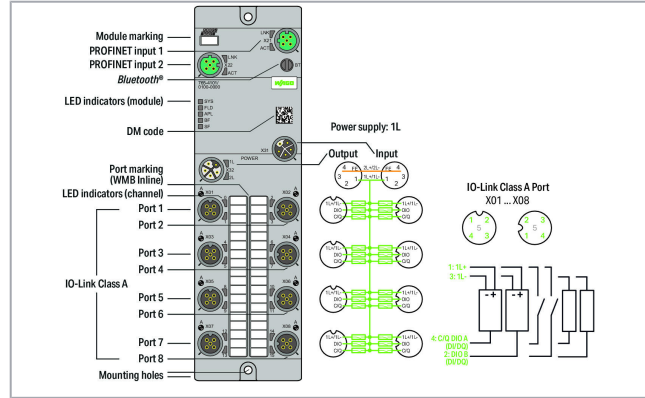

Data

Technical Data

Feldbus

Communication	PROFINET PROFINET IO Device; 2-port switch, LLDP, MRP, SNMP
Connection technology: communication/fieldbus	2 x D-coded M12; 4-pole
Interface standard	10BASE-T/100BASE-TX; potential-free
Autonegotiation; Autocrossover	yes
PROFINET IO properties	PROFINET IO device; 2-port switch, LLDP, MRP, SNMP

Gerätefunktionen

Parameter	Input filter Output current Temperature
Diagnostics	Undervoltage; Overcurrent; Overload; Overtemperature
Device functions	Bluetooth® OPC UA server

Subject to changes. Please also observe the further product documentation!

WAGO Kontakttechnik GmbH & Co. KG
Hansastr. 27
32423 Minden
Phone: +49571 887-0 | Fax: +49571 887-169
Email: info.de@wago.com | Web: www.wago.com

Do you have any questions about our products?
We are always happy to take your call at +49 (571) 887-44222.



Visualization

Android/iOS app

IO-Link Master

IO-Link Master classification	Class A; Specification V1.1
Port mode	IO-Link: autoconfig, manual, tool-based DI DO
Cycle time	400 µs (min.) min. 400 µs
Operating mode	IO-Link master, DI or DO (adjustable for pin 4 per port); DI or DO (adjustable for pin 2 per port)

IO-Link Ports

Number of digital inputs	16
Number of digital outputs	16
Connection technology: inputs/outputs	8 x A-coded M12; 5-pole
Input characteristic	High-side switching
Input filter	0.2 ... 20 ms
Input characteristic	Type 3, per IEC 61131-2
Output current (per channel)	typ. 2 A bei DO

Versorgung Modul

Connection technology: supply	2 x L-coded M12; 5-pole
Supply voltage	24 VDC (18 ... 31.2 V); 1L
Power consumption (max.)	16000 mA
Power consumption (note)	per supply line; overload- and short-circuit-protected
Reverse voltage protection	Yes

Geometrical Data

Width	60 mm / 2.362 inch
Height	30 mm / 1.181 inch
Depth	210 mm / 8.268 inch

Mechanical Data

Weight	610 g
Conformity marking	CE

Subject to changes. Please also observe the further product documentation!

WAGO Kontakttechnik GmbH & Co. KG
 Hansastr. 27
 32423 Minden
 Phone: +49571 887-0 | Fax: +49571 887-169
 Email: info.de@wago.com | Web: www.wago.com

Do you have any questions about our products?
 We are always happy to take your call at +49 (571) 887-44222.

Environmental Requirements



Surrounding air temperature (operation)	-25 ... 70 °C
Surrounding air temperature (storage)	-40 ... 80 °C
Protection type	IP67
Protection class	III per EN 61140, IEC 61140, VDE 0140-1
Operating altitude	0 ... 2000 m 0 ... 2000 m
Pollution degree (5)	3 per EN 60664-1 3 (EN 60664-1)
Overvoltage category	II (EN 60664-1)
Relative humidity (without condensation)	95 %
Vibration resistance	5g per IEC 60068-2-6
Shock resistance	Short-term: 50g/11 ms/half-sine per IEC 60068-2-27; Long-term: 30g/6 ms/half-sine per IEC 60068-2-29
EMC immunity to interference	per EN 61000-6-2
EMC emission of interference	per EN 61000-6-4

Commercial data

Packaging type	BOX
Country of origin	DE
GTIN	4055143949996
Customs tariff number	85371098990

Required accessories



Marking accessories

	Item no.: 2009-110 Marking strips; for Smart Printer; on reel; not stretchable; plain; snap-on type; white	www.wago.com/2009-110
	Item no.: 2009-115 WMB-Inline; for Smart Printer; 1500 pieces on roll; stretchable 5 - 5.2 mm; plain; snap-on type; white	www.wago.com/2009-115

tools

	Item no.: 206-701 Torque wrench M8 and M12; Assembly kit	www.wago.com/206-701
--	--	--













protection

	Item no.: 756-8102 M12 protective cap; for unused sockets; -	www.wago.com/756-8102
	Item no.: 756-8103 M12 protective cap; for unused plugs; -	www.wago.com/756-8103













Subject to changes. Please also observe the further product documentation!

Compatible products













wiring and connectors

	Item no.: 756-1201/060-020 ETHERNET cable; 4-pole; M12 plug, axial; Length: 2 m	www.wago.com/756-1201/060-020
	Item no.: 756-1201/060-050 ETHERNET cable; 4-pole; M12 socket, straight; Length: 5 m	www.wago.com/756-1201/060-050
	Item no.: 756-1201/060-100 ETHERNET cable; 4-pole; M12 socket, straight; Length: 10 m	www.wago.com/756-1201/060-100
	Item no.: 756-1201/060-200 ETHERNET cable; 4-pole; M12 socket, straight; Length: 20 m	www.wago.com/756-1201/060-200
	Item no.: 756-1202/060-020 ETHERNET cable; 4-pole; M12 plug, right angle; Length: 2 m	www.wago.com/756-1202/060-020
	Item no.: 756-1202/060-050 ETHERNET cable; 4-pole; M12 plug, right angle; Length: 5 m	www.wago.com/756-1202/060-050
	Item no.: 756-1202/060-100 ETHERNET cable; 4-pole; M12 plug, right angle; Length: 10 m	www.wago.com/756-1202/060-100
	Item no.: 756-1202/060-200 ETHERNET cable; 4-pole; M12 plug, right angle; Length: 20 m	www.wago.com/756-1202/060-200
	Item no.: 756-1203/060-020 ETHERNET cable; 4-pole; M12 plug, axial; M12 plug, axial; Length: 2 m	www.wago.com/756-1203/060-020
	Item no.: 756-1203/060-050 ETHERNET cable; 4-pole; M12 plug, axial; M12 plug, axial; Length: 5 m	www.wago.com/756-1203/060-050
	Item no.: 756-1203/060-100 ETHERNET cable; 4-pole; M12 plug, axial; M12 plug, axial; Length: 10 m	www.wago.com/756-1203/060-100
	Item no.: 756-1203/060-200 ETHERNET cable; 4-pole; M12 plug, axial; M12 plug, axial; Length: 20 m	www.wago.com/756-1203/060-200













Subject to changes. Please also observe the further product documentation!

	Item no.: 756-1204/060-010 ETHERNET/PROFINET cable, angled; 1 m; fitted on both ends; D-coded; M12 plug, angled; M12 plug, angled; green	www.wago.com/756-1204/060-010
	Item no.: 756-1204/060-020 ETHERNET cable; 4-pole; M12 plug, right angle; M12 plug, right angle; Length: 2 m	www.wago.com/756-1204/060-020
	Item no.: 756-1204/060-030 ETHERNET cable; 4-pole; M12 plug, right angle; M12 plug, right angle; Length: 3 m	www.wago.com/756-1204/060-030
	Item no.: 756-1204/060-050 ETHERNET cable; 4-pole; M12 plug, right angle; M12 plug, right angle; Length: 5 m	www.wago.com/756-1204/060-050
	Item no.: 756-1204/060-100 ETHERNET cable; 4-pole; M12 plug, right angle; M12 plug, right angle; Length: 10 m	www.wago.com/756-1204/060-100
	Item no.: 756-1204/060-200 ETHERNET cable; 4-pole; M12 plug, right angle; M12 plug, right angle; Length: 20 m	www.wago.com/756-1204/060-200
	Item no.: 756-3501/050-020 Power cable; M12L socket; straight; 5-pole; Length: 2 m	www.wago.com/756-3501/050-020
	Item no.: 756-3501/050-050 Power cable; M12L socket; straight; 5-pole; Length: 5 m	www.wago.com/756-3501/050-050
	Item no.: 756-3501/050-075 Power cable; M12L socket; straight; 5-pole; Length: 7.5 m	www.wago.com/756-3501/050-075
	Item no.: 756-3501/050-100 Power cable; M12L socket; straight; 5-pole; Length: 10 m	www.wago.com/756-3501/050-100
	Item no.: 756-3501/050-150 Power cable; M12L socket; straight; 5-pole; Length: 15 m	www.wago.com/756-3501/050-150
	Item no.: 756-3502/050-020 Power cable; M12L socket; angled; 5-pole; Length: 2 m	www.wago.com/756-3502/050-020
	Item no.: 756-3502/050-050 Power cable; M12L socket; angled; 5-pole; Length: 5 m	www.wago.com/756-3502/050-050













Subject to changes. Please also observe the further product documentation!

	Item no.: 756-3502/050-075 Power cable; M12L socket; angled; 5-pole; Length: 7.5 m	www.wago.com/756-3502/050-075
	Item no.: 756-3502/050-100 Power cable; M12L socket; angled; 5-pole; Length: 10 m	www.wago.com/756-3502/050-100
	Item no.: 756-3502/050-150 Power cable; M12L socket; angled; 5-pole; Length: 15 m	www.wago.com/756-3502/050-150
	Item no.: 756-3503/050-020 Power cable; M12L plug; straight; 5-pole; Length: 2 m	www.wago.com/756-3503/050-020
	Item no.: 756-3503/050-050 Power cable; M12L plug; straight; 5-pole; Length: 5 m	www.wago.com/756-3503/050-050
	Item no.: 756-3503/050-075 Power cable; M12L plug; straight; 5-pole; Length: 7.5 m	www.wago.com/756-3503/050-075
	Item no.: 756-3503/050-100 Power cable; M12L plug; straight; 5-pole; Length: 10 m	www.wago.com/756-3503/050-100
	Item no.: 756-3503/050-150 Power cable; M12L plug; straight; 5-pole; Length: 15 m	www.wago.com/756-3503/050-150
	Item no.: 756-3504/050-020 Power cable; M12L plug; angled; 5-pole; Length: 2 m	www.wago.com/756-3504/050-020
	Item no.: 756-3504/050-050 Power cable; M12L plug; angled; 5-pole; Length: 5 m	www.wago.com/756-3504/050-050
	Item no.: 756-3504/050-075 Power cable; M12L plug; angled; 5-pole; Length: 7.5 m	www.wago.com/756-3504/050-075
	Item no.: 756-3504/050-100 Power cable; M12L plug; angled; 5-pole; Length: 10 m	www.wago.com/756-3504/050-100
	Item no.: 756-3504/050-150 Power cable; M12L plug; angled; 5-pole; Length: 15 m	www.wago.com/756-3504/050-150

Subject to changes. Please also observe the further product documentation!

	Item no.: 756-3505/050-003 Power cable; M12L socket; straight; M12L plug; straight; 5-pole; Length: 0.3 m	www.wago.com/756-3505/050-003
	Item no.: 756-3505/050-005 Power cable; M12L socket; straight; M12L plug; straight; 5-pole; Length: 0.5 m	www.wago.com/756-3505/050-005
	Item no.: 756-3505/050-010 Power cable; M12L socket; straight; M12L plug; straight; 5-pole; Length: 1 m	www.wago.com/756-3505/050-010
	Item no.: 756-3505/050-020 Power cable; M12L socket; straight; M12L plug; straight; 5-pole; Length: 2 m	www.wago.com/756-3505/050-020
	Item no.: 756-3505/050-050 Power cable; M12L socket; straight; M12L plug; straight; 5-pole; Length: 5 m	www.wago.com/756-3505/050-050
	Item no.: 756-3505/050-075 Power cable; M12L socket; straight; M12L plug; straight; 5-pole; Length: 7.5 m	www.wago.com/756-3505/050-075
	Item no.: 756-3505/050-100 Power cable; M12L socket; straight; M12L plug; straight; 5-pole; Length: 10 m	www.wago.com/756-3505/050-100
	Item no.: 756-3505/050-150 Power cable; M12L socket; straight; M12L plug; straight; 5-pole; Length: 15 m	www.wago.com/756-3505/050-150
	Item no.: 756-3506/050-003 Power cable; M12L socket; angled; M12L plug; angled; 5-pole; Length: 0.3 m	www.wago.com/756-3506/050-003
	Item no.: 756-3506/050-005 Power cable; M12L socket; angled; M12L plug; angled; 5-pole; Length: 0.5 m	www.wago.com/756-3506/050-005
	Item no.: 756-3506/050-010 Power cable; M12L socket; angled; M12L plug; angled; 5-pole; Length: 1 m	www.wago.com/756-3506/050-010
	Item no.: 756-3506/050-020 Power cable; M12L socket; angled; M12L plug; angled; 5-pole; Length: 2 m	www.wago.com/756-3506/050-020
	Item no.: 756-3506/050-050 Power cable; M12L socket; angled; M12L plug; angled; 5-pole; Length: 5 m	www.wago.com/756-3506/050-050

Subject to changes. Please also observe the further product documentation!

	Item no.: 756-3506/050-075 Power cable; M12L socket; angled; M12L plug; angled; 5-pole; Length: 7.5 m	www.wago.com/756-3506/050-075
	Item no.: 756-3506/050-100 Power cable; M12L socket; angled; M12L plug; angled; 5-pole; Length: 10 m	www.wago.com/756-3506/050-100
	Item no.: 756-3506/050-150 Power cable; M12L socket; angled; M12L plug; angled; 5-pole; Length: 15 m	www.wago.com/756-3506/050-150
	Item no.: 756-5311/040-015 Sensor/Actuator cable; 4-pole; Length: 1.5 m	www.wago.com/756-5311/040-015
	Item no.: 756-5311/040-050 Sensor/Actuator cable; 4-pole; Length: 5 m	www.wago.com/756-5311/040-050
	Item no.: 756-5311/040-100 Sensor/Actuator cable; 4-pole; Length: 10 m	www.wago.com/756-5311/040-100
	Item no.: 756-5312/040-015 Sensor/Actuator cable; 4-pole; Length: 1.5 m	www.wago.com/756-5312/040-015
	Item no.: 756-5312/040-050 Sensor/Actuator cable; 4-pole; Length: 5 m	www.wago.com/756-5312/040-050
	Item no.: 756-5312/040-100 Sensor/Actuator cable; 4-pole; Length: 10 m	www.wago.com/756-5312/040-100
	Item no.: 756-5401/040-010 Sensor/Actuator cable; 4-pole; Length: 1 m	www.wago.com/756-5401/040-010
	Item no.: 756-5401/040-020 Sensor/Actuator cable; 4-pole; Length: 2 m	www.wago.com/756-5401/040-020
	Item no.: 756-5402/040-010 Sensor/Actuator cable; 4-pole; Length: 1 m	www.wago.com/756-5402/040-010
	Item no.: 756-5402/040-020 Sensor/Actuator cable; 4-pole; Length: 2 m	www.wago.com/756-5402/040-020

Subject to changes. Please also observe the further product documentation!



Item no.: 756-5403/040-010
Sensor/Actuator cable; 4-pole; Length: 1 m

www.wago.com/756-5403/040-010



Item no.: 756-5403/040-020
Sensor/Actuator cable; 4-pole; Length: 2 m

www.wago.com/756-5403/040-020



Item no.: 756-5404/040-010
Sensor/Actuator cable; 4-pole; Length: 1 m

www.wago.com/756-5404/040-010



Item no.: 756-5404/040-020
Sensor/Actuator cable; 4-pole; Length: 2 m

www.wago.com/756-5404/040-020



Item no.: 756-5507/040-010
Sensor/Actuator cable; 4-pole; Length: 1 m

www.wago.com/756-5507/040-010



Item no.: 756-5507/040-020
Sensor/Actuator cable; 4-pole; Length: 2 m

www.wago.com/756-5507/040-020



Item no.: 756-5508/040-010
Sensor/Actuator cable; 4-pole; Length: 1 m

www.wago.com/756-5508/040-010



Item no.: 756-5508/040-020
Sensor/Actuator cable; 4-pole; Length: 2 m

www.wago.com/756-5508/040-020



Item no.: 756-5509/040-010
Sensor/Actuator cable; 4-pole; Length: 1 m

www.wago.com/756-5509/040-010



Item no.: 756-5509/040-020
Sensor/Actuator cable; 4-pole; Length: 2 m

www.wago.com/756-5509/040-020



Item no.: 756-5510/040-010
Sensor/Actuator cable; 4-pole; Length: 1 m

www.wago.com/756-5510/040-010



Item no.: 756-5510/040-020
Sensor/Actuator cable; 4-pole; Length: 2 m

www.wago.com/756-5510/040-020



Item no.: 756-5513/040-010
Sensor/Actuator cable; 4-pole; Length: 1 m

www.wago.com/756-5513/040-010

Subject to changes. Please also observe the further product documentation!



Item no.: 756-5513/040-020
Sensor/Actuator cable; 4-pole; Length: 2 m

www.wago.com/756-5513/040-020



Item no.: 756-5514/040-010
Sensor/Actuator cable; 4-pole; Length: 1 m

www.wago.com/756-5514/040-010



Item no.: 756-5514/040-020
Sensor/Actuator cable; 4-pole; Length: 2 m

www.wago.com/756-5514/040-020



Item no.: 756-5516/040-010
Sensor/Actuator cable; 4-pole; Length: 1 m

www.wago.com/756-5516/040-010



Item no.: 756-5516/040-020
Sensor/Actuator cable; 4-pole; Length: 2 m

www.wago.com/756-5516/040-020



Item no.: 756-5517/040-010
Sensor/Actuator cable; 4-pole; Length: 1 m

www.wago.com/756-5517/040-010



Item no.: 756-5517/040-020
Sensor/Actuator cable; 4-pole; Length: 2 m

www.wago.com/756-5517/040-020



Item no.: 756-9202/040-000
Accessories; 4-pole

www.wago.com/756-9202/040-000



Item no.: 756-9205/040-000
Accessories; 4-pole

www.wago.com/756-9205/040-000



Item no.: 756-9301/040-000
Accessories; 4-pole

www.wago.com/756-9301/040-000



Item no.: 756-9301/050-000
Accessories; 5-pole

www.wago.com/756-9301/050-000



Item no.: 756-9501/040-000
Accessories; 4-pole; M12 plug, right angle

www.wago.com/756-9501/040-000



Item no.: 756-9501/060-000
Fitted pluggable connector; 4-pole, shielded; M12 plug, straight, D-coded; Spring

www.wago.com/756-9501/060-000

Subject to changes. Please also observe the further product documentation!



Item no.: 756-9503/040-000
Accessories; 4-pole

www.wago.com/756-9503/040-000



Item no.: 756-9504/040-000
Accessories; 4-pole

www.wago.com/756-9504/040-000



Item no.: 756-9701/050-000
Fitted pluggable connector; 5-pole; M12 plug, straight; IDC technology

www.wago.com/756-9701/050-000



Item no.: 756-9711/050-000
Fitted pluggable connector; 5-pole; M12 socket, straight; IDC technology

www.wago.com/756-9711/050-000

Downloads

Documentation

Manual

8-Port IO-Link Master Class A; Profinet DC 24 V / 2.0 A; 8xM12 Connection; WideLine	V 2.1.0 30. 11. 2020	pdf 4.2 MB	Download
--	-------------------------	---------------	----------

System Description

WAGO I/O System Field; General Product Information		pdf 708.2 kB	Download
--	--	-----------------	----------

Engineering-Software

WAGO IO-Link Configurator

WAGO IO-Link Configurator	V5.1.1 17. 12. 2020	ZIP 25.2 MB	Download
---------------------------	------------------------	----------------	----------

The WAGO IO-Link Configurator is standalone commissioning, configuration and management software for the WAGO Field I/O System's IO-Link Master and Hubs.

It supports all IO-Link devices per the IO-Link specification and allows automatic download of IODDs via integrated IODD Finder.

Register now and test our engineering software for 30 days at no cost.

CAD/CAE-Data

CAD data

2D/3D Models 765-4101/100-000		URL	Download
-------------------------------	--	-----	----------

Subject to changes. Please also observe the further product documentation!



CAE data

ZUKEN Portal 765-4101/100-000	URL	Download
-------------------------------	-----	----------

Device Files

Device Description File

750-916; GSD-Dateien der Version 2.x für PROFINET/ Serie 750/753, 765, 767 und 852	2.8 15. 1. 2021	zip 2.6 MB	Download
--	--------------------	---------------	----------

Environmental Product Compliance

Compliance Search

Environmental Product Compliance 765-4101/100-000	URL	Download
8-Port-IO Link Master Class A; Profinet; DC 24 V / 2.0 A; 8xM12 connection; WideLine		

Installation Notes

Product family

I/O System Field
[Show all products from the family](#)

Subject to changes. Please also observe the further product documentation!

WAGO Kontakttechnik GmbH & Co. KG
Hansastr. 27
32423 Minden
Phone: +49571 887-0 | Fax: +49571 887-169
Email: info.de@wago.com | Web: www.wago.com

Do you have any questions about our products?
We are always happy to take your call at +49 (571) 887-44222.