

*Technical Information for Maxell Lead-Free Oxygen Sensor KE-LF Series*

The Maxell Lead-Free Oxygen Sensor KE-LF Series are unique galvanic cell type oxygen sensors which provides a linear output voltage signal relative to percent oxygen present in a particular atmosphere. The sensor is lead-free and features long life expectancy, excellent chemical durability, and is not influenced by CO<sub>2</sub>, making it ideal for oxygen monitoring.



	<u>Page</u>
<i>Introduction</i> .....	2
<i>Basic Information and Specifications</i>	
Features.....	2
Applications.....	2
Structure and Operating Principle.....	2
Specifications.....	2
Absolute Maximum Operating and Storage Conditions.....	2
Dimensions.....	3
<i>Typical Sensitivity Characteristics</i>	
Sensitivity to Oxygen.....	4
Response Time.....	4
Influence of Various Gases.....	4
Effects of Pressure Change.....	5
Humidity Dependency.....	5
Temperature Dependency.....	5
<i>Reliability</i>	
Influence of Organic Solvents.....	6
Life Expectancy.....	6
Relationship between Expected Life and O <sub>2</sub> Concentration.....	6
Relationship between Expected Life and Storage Temperature....	6
Long Term Stability.....	7
<i>Cautions</i> .....	7
<i>Limited Warranty and Limitation of Liability</i> .....	8

## 1. Introduction

The Maxell Oxygen Sensor KE-LF Series (KE-25LF and KE-50LF) are unique galvanic cell-type oxygen sensors developed by Maxell, Ltd., Japan. Their most notable features are lead-free structure, long life expectancy, excellent chemical durability, and no influence by CO<sub>2</sub>. KE-LF Series oxygen sensors are ideal to meet the ever-increasing demand for oxygen monitoring in various fields such as combustion gas monitoring, the biochemical field, domestic combustion appliances, etc.

## 2. Basic Information and Specifications

### 2-1 Features

- \* Lead-free galvanic cell-type sensor
  - no external power supply required for sensor operation
  - no warmup time required
  - meets RoHS2 directive
- \* Weak acid electrolyte
  - virtually no influence from CO<sub>2</sub>, H<sub>2</sub>S, SO<sub>2</sub>
  - long life (KE-25LF - 5 years / KE-50LF - 10 years in atmospheric air)

### 2-2 Applications

- \* Safety - Oxygen detectors
- \* Environmental controls - Combustion gas monitoring
- \* Food industry - Refrigeration, greenhouses
- \* Educational material - Oxygen test kits

### 2-3 Structure and operating principle (see Figure. 1)

The KE-LF series sensor is a metal-air battery which incorporates a metal anode, an oxygen cathode, and a weak acid electrolyte. Oxygen molecules enter the electrochemical cell through a non-porous fluorine resin membrane and are reduced at the cathode with the acid electrolyte. The current which flows between the electrodes is proportional to the oxygen concentration in the gas mixture being measured. The terminal voltages across the thermistor (for temperature compensation) and resistor are read as a signal, with the change in output voltages representing the change in oxygen concentration.

A small volume air bubble is contained inside the sensor body in order to compensate for internal influence from pressure changes. The sensor's body is made of ABS resin.

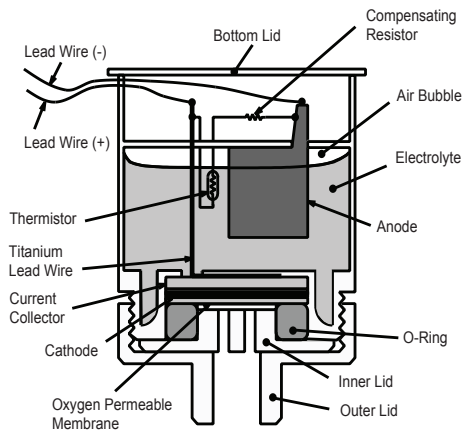

Fig. 1 - Structure of KE-LF sensors

### 2-4 Specifications

Table 1 shows the specifications of the KE-LF series oxygen sensors.

#### Notes:

- 1) When calibrated at both 0% and 30% of O<sub>2</sub>, accuracy in the range from 0-30% O<sub>2</sub> shall be within  $\pm 1\%$  of full scale for KE-25LF and  $\pm 2\%$  of full scale for KE-50LF.
- 2) V<sub>a</sub> = output voltage at 21% O<sub>2</sub>  
 V<sub>0</sub> = output voltage at 0% O<sub>2</sub>  
 V<sub>30</sub> = output voltage at 30% O<sub>2</sub>
- 3) Sensors should be used under conditions where the air exchange is greater than 200~300ml per minute in order to obtain the response speed as specified in Table 1.

Item	Model	
	KE-25LF KE-25F3LF	KE-50LF
Measurement range	0~30% O <sub>2</sub>	
Accuracy (Note 1)	$\pm 1\%$ full scale	$\pm 2\%$ full scale
Operating conditions	Atmospheric pressure	811hPa~1216hPa
	Temperature	5~40°C
	Relative humidity	10~90%RH (no condensation)
Response time (90%) (Note 3)	approx. 15 sec.	approx. 60 sec.
Initial output voltage under factory test conditions	10.0~15.5mV	4.5~7.5mV
Factory test conditions	Test gas	21% O <sub>2</sub>
	Atmospheric pressure	1013hPa
	Temperature	25°C
Linearity	$(V_a - V_0) / (V_{30} - V_0)$ (Note 2)	0.70 $\pm$ 0.07
Offset voltage	V <sub>0</sub>	$\leq 0.5$ mV

Table 1 - Specifications of KE-LF sensors

## TECHNICAL INFORMATION FOR KE-LF SERIES

### 2-5 Absolute maximum operating and storage conditions

The accumulated total duration of exposure to the absolute maximum conditions listed in Table 2 should be limited to no more than 24 hours.

#### Cautions:

- 1) Beneath the lower pressure limit, sensor life may become shorter due to excessive evaporation of the liquid electrolyte.
- 2) At pressure in excess of the upper limit, sensor output may become unstable due to excessive air entering through the o-ring.
- 3) In the range -10~-20°C, the electrolyte will freeze and the sensor will not function, but KE-LF sensors would not be damaged by freezing of the electrolyte and will resume functioning after the electrolyte thaws to a liquid state. Below -20°C, the sensor may be damaged by freezing of the electrolyte, resulting in possible leakage of the electrolyte.
- 4) At temperatures in excess of the upper limit, the

Item	Lower limit	Upper limit
Pressure	507hPA (Caution 1)	1520hPA (Caution 2)
Temperature	-20°C (Caution 3)	60°C (Caution 4)
Relative humidity	0%RH (Caution 5)	100%RH

Table 2 - Absolute maximum operating and storage conditions of KE-LF sensors

ABS resin casing may deteriorate.

- 5) If used for a long period in an extremely dry environment, sensor life may be shortened due to excessive evaporation of the liquid electrolyte.

### 2-6 Dimensions (see Figuer. 2)

The dimensions of the KE-LF sensors are identical to KE-series oxygen sensors (please refer to the document *Technical Information for Maxell Oxygen Sensor KE-Series*), ensuring easy replacement of the KE-series oxygen sensors at site.

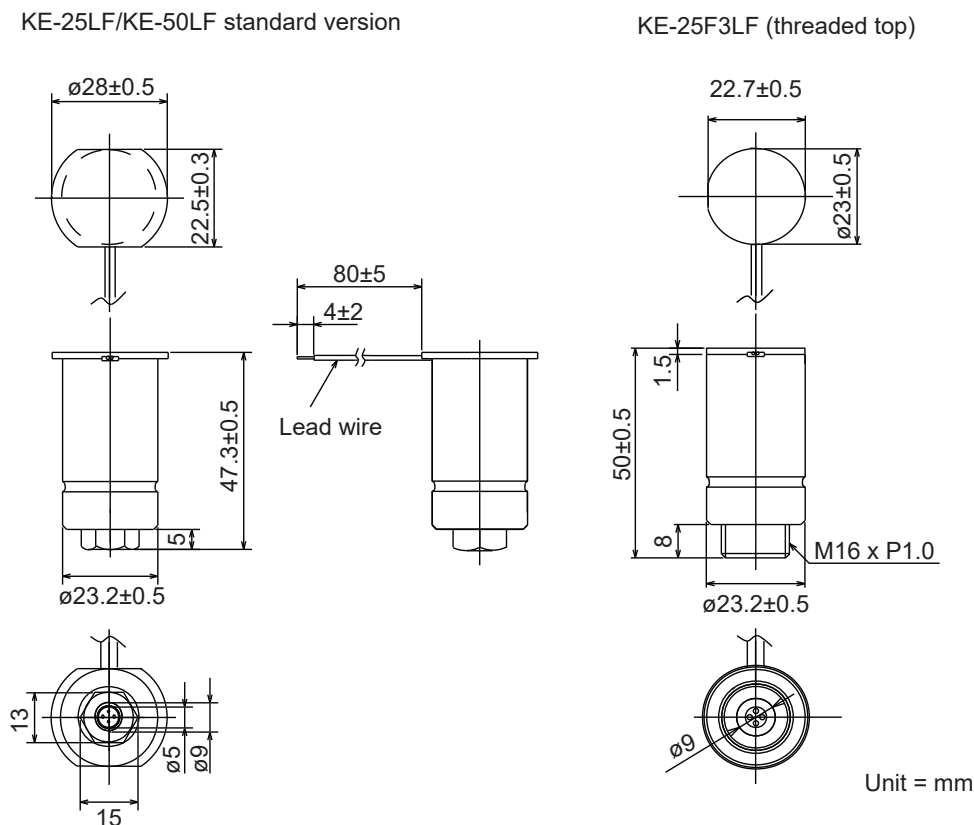

Fig. 2 - Dimensions of KE-LF sensors

### 3. Typical Sensitivity Characteristics

#### 3-1 Sensitivity to oxygen

Figures 3a and 3b show the sensitivity characteristics of the KE-LF sensors. The Y-axis indicates the output voltage of the sensor.

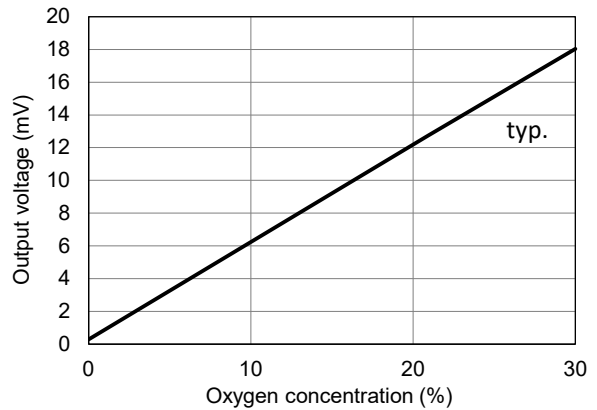

Fig. 3a - KE-25LF sensitivity characteristics

#### 3-2 Response time

Figure 4 demonstrates the response pattern of the sensor's output voltage. The Y-axis indicates the output voltage ratio (%) to saturated voltage. Typical response time to 90% of saturated response is 15 seconds for KE-25LF and 50 seconds for KE-50LF.

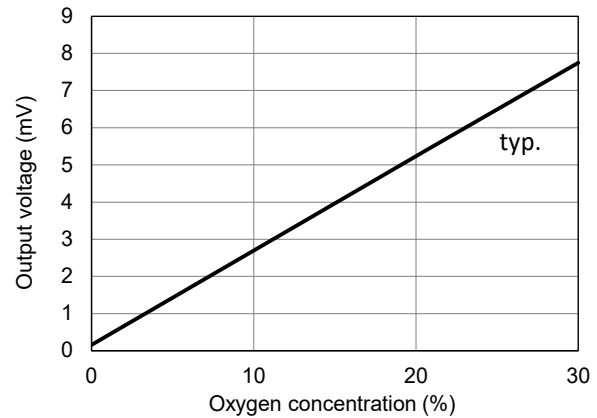

Fig. 3b - KE-50LF sensitivity characteristics

#### 3-3 Influence of various gases

The influence on KE-LF sensors from various gases is shown in Table 3. The 'interference level' shown in the table indicates the difference between sensor output in nitrogen gas(N<sub>2</sub>) and gas mixture compared to sensor output in nitrogen gas(N<sub>2</sub>). For example, if the interference level of NO<sub>2</sub> at 517ppm is considered to be +0.1% O<sub>2</sub>, that would indicate that the sensor's output voltage in normal air (20.9% O<sub>2</sub>) would correspond to a concentration of 21.0% O<sub>2</sub> (20.9% +0.1%).

Gas	Concentration	Interference Level
Carbon dioxide	100%	no effect
Hydrogen	1000ppm	no effect
Hydrogen sulfide	50.3ppm	no effect
Nitric monoxide	467ppm	no effect
Nitrogen dioxide	517ppm	+0.1 O <sub>2</sub>
Sulfur dioxide	46.6ppm	no effect
Ammonia	0.996%	no effect

Table 3 - Influence of various gases on KE-LF series sensors

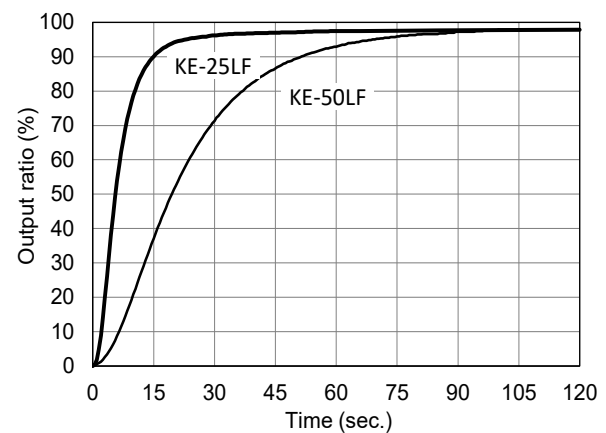

Fig. 4 - Response speed of KE-LF sensors to oxygen

3-4 Effects of pressure change

The pressure dependency of KE-LF sensors can be seen in Figures 5a and 5b. In this range of atmospheric pressure, sensor output voltage maintains a linear relationship when compared with atmospheric pressure.

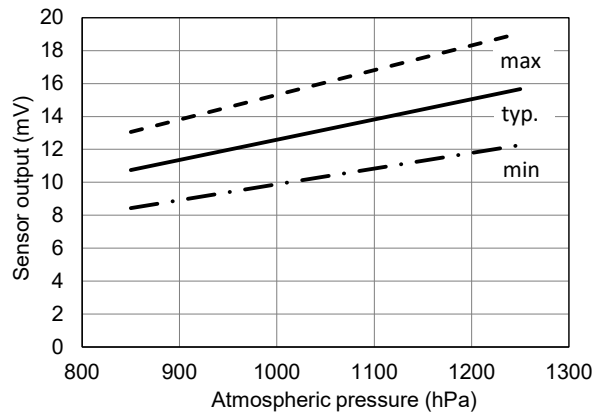

Fig. 5a- KE-25LF response of output voltage to ambient pressure changes (at 25°C/60%RH)

3-5 Humidity dependency

The sensor itself is not influenced by humidity. However, if water vapor is present in the measurement gas, the amount of oxygen per unit volume decreases according to the relative humidity of air. As a result, the oxygen concentration (vol. %) decreases, as indicated in Figure 6.

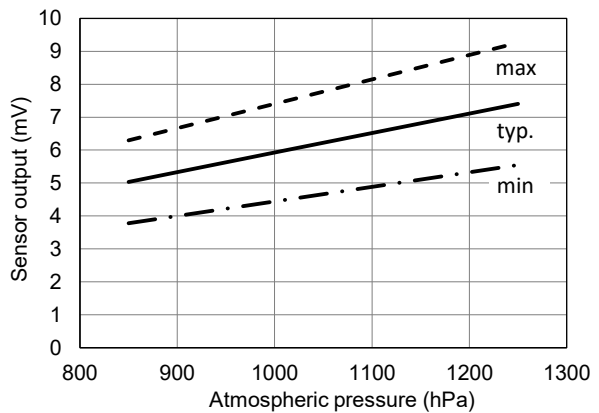

Fig. 5b- KE-50LF response of output voltage to ambient pressure changes (at 25°C/60%RH)

3-6 Temperature dependency

The standard KE-LF sensor has a built-in temperature compensation circuit which uses a thermistor that is mounted inside the sensor's body (see Figure 1). The temperature dependency of the KE-LF series with this built-in compensation circuit is shown in Figures 7a and 7b.

The KE-LF sensor may show some transient characteristics if the ambient temperature changes very widely and quickly. This is caused by the difference in response speed to temperature changes between the sensor compartment and the built-in thermistor. A quick rise in ambient temperature temporarily makes output voltage high and vice versa for a quick fall in temperature. Such temporary drift disappears after the sensor's temperature reaches equilibrium with the ambient temperature. For avoiding this problem, the sensor should be protected from quick temperature changes (such as direct exposure to sunlight or wind) by some kind of enclosure.

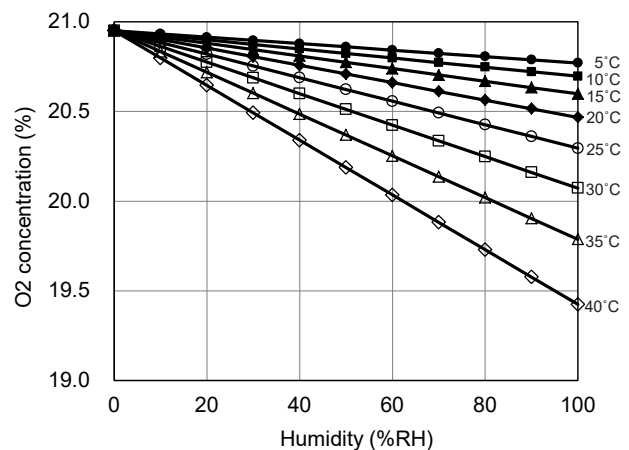

Fig. 6 - Effect of humidity on O2 concentration

In addition, temperature should be kept uniform throughout the sensor's structure in order to avoid improper compensation caused by differences in temperature between the sensing area and the thermistor location.

#### 4. Reliability

##### 4-1 Influence of organic solvents

Exposure to organic solvents such as toluene, benzene, xylene, acetone, methyl ethyl ketone, methyl chloride, kerosene, gasoline, naphtha and gas oil may cause the sensor's external housing (ABS resin) to degenerate and degrade, resulting in unstable output voltage. Condensation of such solvents on the sensor would cause adverse influence on output voltage and response speed. To reduce potential risk of exposure to these solvents, installation of a filter or condenser on the sensor is recommended.

##### 4-2 Life expectancy

The life expectancy of the KE-LF oxygen sensor is expressed in %-hours as follows:

$$[\text{Oxygen Concentration (\%)}] \times [\text{Exposure Time (hours)}]$$

Accordingly, the life of KE-50LF is approximately 1,800,000 %-hours, and KE-25LF is 900,000 %-hours.

The end of life for KE-LF sensors is defined as the point at which output voltage is reduced to 70% from the initial output voltage of the sensor. These facts indicate that the expected life time in ambient conditions (21% O<sub>2</sub> at 20°C) is 10 years for KE-50LF and 5 years for KE-25LF.

##### a) Relationship between expected life and O<sub>2</sub> concentration

Figure 8a shows the relationship between life expectancy and O<sub>2</sub> concentration for KE-LF sensors. The Y-axis indicates the ratio of life expectancy in a given O<sub>2</sub> concentration (L) to life expectancy in natural air (Lo). The greater the O<sub>2</sub> concentration, the shorter the life expectancy. The influence of atmospheric pressure on life expectancy is estimated based on the O<sub>2</sub> concentration in a given atmospheric pressure.

##### b) Relationship between expected life and storage temperature

Figure 8b shows the relationship between life expectancy and ambient temperature. The Y-axis indicates the ratio of life expectancy at a given temperature (L) compared to life expectancy at 20°C (Lo). A correlation exists between the sensor's life time and its storage temperature—the life time becomes shorter as the storage temperature increases.

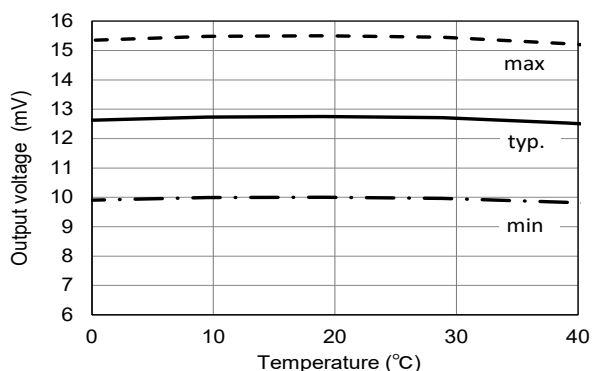

Fig. 7a - KE-25LF temperature dependency of output voltage

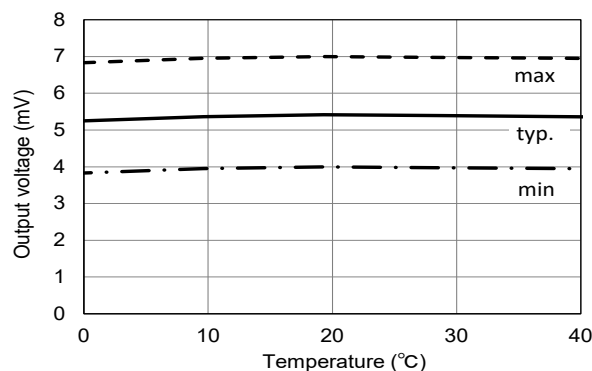

Fig. 7b - KE-50LF temperature dependency of output voltage

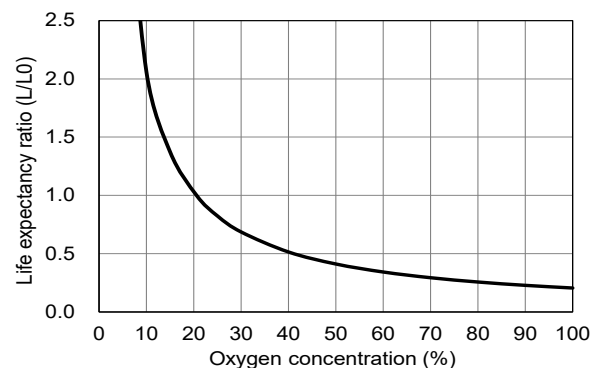

Fig. 8a - Relationship of life expectancy vs. O<sub>2</sub> concentration (Lo = life at 20.9% O<sub>2</sub>)

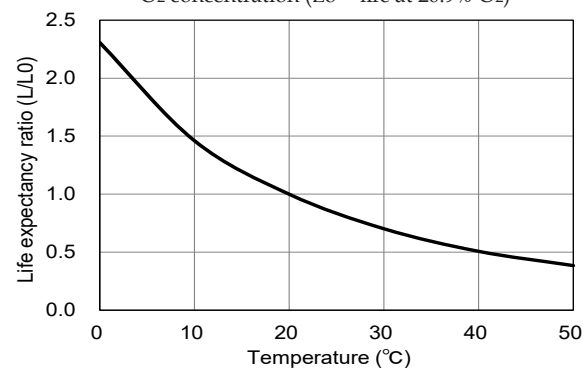

Fig. 8b - Relationship of life expectancy vs. temperature (Lo = life at 20°C)

4-3 Long term stability

When used in normal air (20°C, 21%O<sub>2</sub>), both KE-25LF and KE-50LF typically show good long-term characteristics as illustrated in Figure 9a and 9b. The long-term output characteristics are estimated based on the acceleration test under the high temperature and the high O<sub>2</sub> concentration. The output voltage of the KE-LF series oxygen sensor gradually decreases over time. It is recommended to calibrate the sensor periodically when accurate measurement is required. The higher the oxygen concentration, the greater the change in output voltage over the sensor life.

*Please note that there are various factors which may influence the life time of KE-LF oxygen sensors in actual use and that their life span can be variable.*

5. Cautions

5-1 Required oxygen amount

KE-LF sensors consume a small amount of oxygen during the detection process. It is recommended that these sensors be used under conditions where the air exchange is greater than 2~3ml per minute to offset the sensor's oxygen consumption. Please note that sensors should be used under conditions where the air exchange is greater than 200~300ml per minute in order to obtain response speed specified in Table 1.

5-2 Mechanical strength against shock and vibration

Since mechanical shock and vibration may potentially influence the sensitivity characteristics of the sensor, these factors should be avoided in actual usage. Temporary changes/instability in the sensor's output signal may result due to these factors, but the signal may recover to its original state after the sensor is kept motionless in natural air/room temperature for between several hours to several days. If the mechanical shock or vibration is great, an irreversible change in the output signal may occur due to structural damage within the sensor. Shock absorbing measures should be used to protect the sensor during transportation or when used for applications in which shock/vibration is likely to occur.

5-3 Position dependency

At all times the sensor is recommended to be kept either horizontal or in the normal vertical position

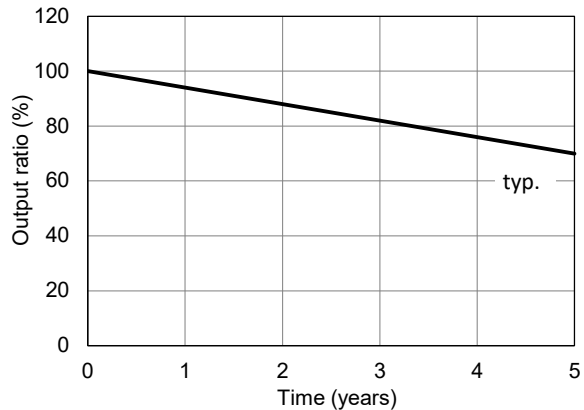

Fig. 9a - KE-25LF long term stability

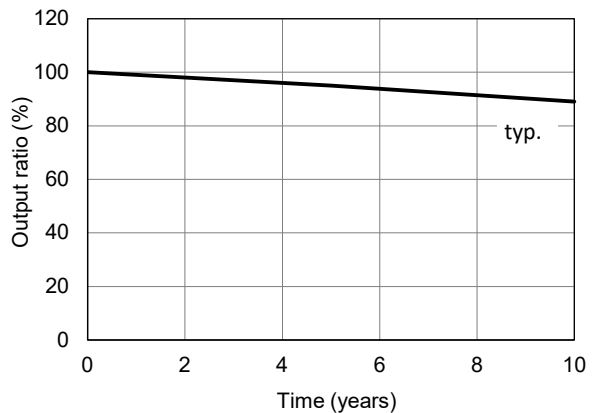

Fig. 9b - KE-50LF long term stability

(refer to side view in Figure 2) in order to prevent the cathode from drying out. If this were to occur, the sensor's output signal would fluctuate.

5-4 Low O<sub>2</sub> concentration detection

When less than 1% O<sub>2</sub> is measured, offset voltage (which appears at close to 0% of O<sub>2</sub>) should be taken into consideration when calculating O<sub>2</sub> concentration. For details, please refer to the document *Application Notes on Offset Voltage and Low Concentration Measurement*.

5-5 Storage conditions

To prolong the life expectancy of KE-LF sensors, storage at low temperature (in a refrigerator) and at low oxygen concentration is recommended. Care should also be taken to ensure that the lead wires are not connected or shorted during storage as this may cause slow response to oxygen.

If the sensor is stored in a 0% O<sub>2</sub> environment for an extended period of time, the sensor's offset voltage (see Sec. 5-4) becomes lower and response speed to O<sub>2</sub> will become slower. In this case, the sensor will be able to recover to normal response speed after exposure to a normal environment for a period of 24 hours. However, if the sensor is stored in such a condition for 3 days or longer, sensor characteristics may not recover to the original state.

The absolute minimum storage temperature for the sensor is -20°C. Below this temperature, the sensor may be damaged by freezing of the electrolyte, resulting in possible leakage of the electrolyte.

The specified maximum storage temperature is 60°C. This is a result of the temperature limitation of ABS resin, the material which is used to make the sensor's body.

### 5-6 Influence of condensation

Measures should be taken to prevent condensation on the sensor because the output signal will degrade and response speed will decrease, causing inaccurate measurement. However, once condensation dissipates, sensor characteristics will recover to their original state.

### 5-7 Recommended input impedance

The sensor must be connected to equipment which has an input impedance of 1000kΩ or greater. If not, proper temperature compensation would not be possible.

### 5-8 Sensor connection

The sensor must not have a counter-electromotive force applied to it from any equipment to which it is connected. Application of external electric potential to the sensor's output terminals may cause temporary instability in the output signal and reduced response speed. However, removal of this condition and subsequent aging in normal air for several days will allow the sensor to recover to normal.

If reverse polarity or excessive voltage is applied to the sensor, the characteristic change would be irreversible due to the internal electrical damage caused by this condition. For example, if several 10mV of reverse voltage were applied, the internal electrode would be broken.

### 5-9 Disassembly or repair of the sensor

Disassembling or repair of the sensor should be avoided because it will result in a change of sensitivity characteristics. The reason for such a change is related to the sensor's structure. The most important factor in determining sensitivity is the condition of the cathode which is determined by affixing the membrane with a suitable pressure via tightening the plastic top. Loosening of the plastic top will change the internal pressure and therefore change the sensor's sensitivity.

The plastic label covering the sensor's housing should not be removed since the label is used as a seal to fasten and immobilize the plastic top on the sensor's body.

### 5-10 Safety measures for electrolyte leakage

If the liquid electrolyte leaks due to sensor breakage, care should be taken in handling the sensor, which should immediately be placed into a plastic bag. The liquid electrolyte is a weak aqueous acid solution (pH=4~5) with an irritating odor. The liquid is non-flammable.

In case the liquid electrolyte contacts the skin or clothing, wash with soapy water and rinse generously with plain water. If the liquid electrolyte contacts the eye, flush with water for at least 15 minutes and obtain immediate medical assistance. In case of breathing in of the electrolyte, flush the nasal cavity thoroughly with water and seek immediate medical assistance. If the electrolyte is swallowed, rinse the mouth thoroughly with water and seek immediate medical assistance.

### 5-11 Disposal

Spent KE-LF series oxygen sensors should be disposed of in accordance with applicable regional, national, and local laws and regulations.

### 5-12 When designing equipment using KE-LF series oxygen sensors

Sensor characteristics may be affected by environmental conditions of use, such as ambient temperature, humidity, gas pressure, flow rate, etc. Sensor performance should be evaluated under actual operating conditions before usage.



### 6. Limited Warranty and Limitation of Liability

KE-LF series oxygen sensors shall be warranted for 12 months after the date of purchase from Figaro. Provided that return of the sensor to Figaro is made within the warranty period, if it is determined upon reasonable inspection tests that any of the following defects exists, returned sensors will be replaced free of charge with a new sensor of the identical model.

- 1) The output voltage of the sensor in normal air is 7mV or less.
- 2) The output voltage change is not proportional to the change in oxygen concentration.

The warranty of the replacement sensor will continue for the warranty period of the original KE-LF series product.

**THIS WARRANTY SHALL NOT APPLY IN THE EVENT OF FAILURE TO COMPLY WITH ANY INSTRUCTIONS OR CAUTIONS PROVIDED BY FIGARO, AND TO ANY KE-SERIES PRODUCTS OR PORTIONS THEREOF WHICH HAVE BEEN SUBJECTED TO ABUSE, MISUSE, IMPROPER INSTALLATION, STORAGE OR MAINTENANCE, OR IMPROPER OPERATION UNDER THE CONDITIONS WHICH DEVIATE SIGNIFICANTLY FROM NORMAL AMBIENT AIR AND TEMPERATURE. IN NO EVENT SHALL FIGARO ENGINEERING INC. (SELLER) OR MAXELL, LTD. (MANUFACTURER) BE LIABLE TO PURCHASER, ITS CUSTOMER, ITS ASSIGNS OR AGENTS, FOR ECONOMIC LOSS, INCIDENTAL OR CONSEQUENTIAL DAMAGES WHETHER BASED UPON WARRANTY, CONTRACT, OR TORT INCLUDING NEGLIGENCE AND PRODUCT LIABILITY WHETHER AT EQUITY OR AT LAW, INCLUDING BUT NOT LIMITED TO ANY DAMAGES FOR WORKMANSHIP ARISING DIRECTLY OR INDIRECTLY FROM USE OF THE KE-SERIES PRODUCTS.**

KE-LF series oxygen sensors are designed, manufactured and tested for industrial application only. The products are not designed, manufactured, tested, or intended specifically for use in or incorporation into artificial respirators, ventilators and/or other equipment for medical application, or subassembly modules or parts thereof (“Medical devices”).

Notwithstanding the foregoing above, in case that the purchaser intends to use the KE-LF series products for incorporation into or with the Medical devices, which is against the foregoing, the purchaser shall assume all risk for such use, and make an assessment and judgement on fitness of the KE-LF series products for such use in the Medical devices and on safety of the Medical devices using the KE-LF series products based on evaluations of reliability of the KE-LF series products to be carried out by the purchaser as required for such use through a thorough understanding of the contents in this Technical Information and other technical information provided by the Seller.

By purchasing the KE-LF series products and using them for incorporation into or with the Medical devices, the purchaser agrees to provide the Seller upon request from the Seller with valid proof of approvals and permissions required to manufacture and sell such Medical devices in accordance with applicable regional, national, and local laws and regulations.

Figaro reserves the right to make changes without notice to any products herein to improve reliability, functioning or design. Information contained in this document is believed to be reliable. However, Figaro does not assume any liability arising out of the application or use of any product or circuit described herein; neither does it convey any license under its patent rights, nor the rights of others.

Before purchasing this product, please read the Warranty Statements shown in our webpage by scanning this QR code.

[https://figarosensor.com/pdf/Figaro\\_USA\\_Sales\\_T&C.pdf](https://figarosensor.com/pdf/Figaro_USA_Sales_T&C.pdf)



Manufacturer: Maxell, Ltd.  
Distributor: **FIGARO USA, INC.**  
5400 Newport Drive, Suite 19, Rolling Meadows, IL 60008  
Phone: (847)-832-1701  
URL: **[www.figarosensor.com](http://www.figarosensor.com)**