

## Data sheet | Item number: 2042-3839

Relay module; Nominal input voltage: 24 ... 230 V AC/DC; 1 changeover contact; Limiting continuous current: 4 A; Green status indicator; Module width: 15 mm

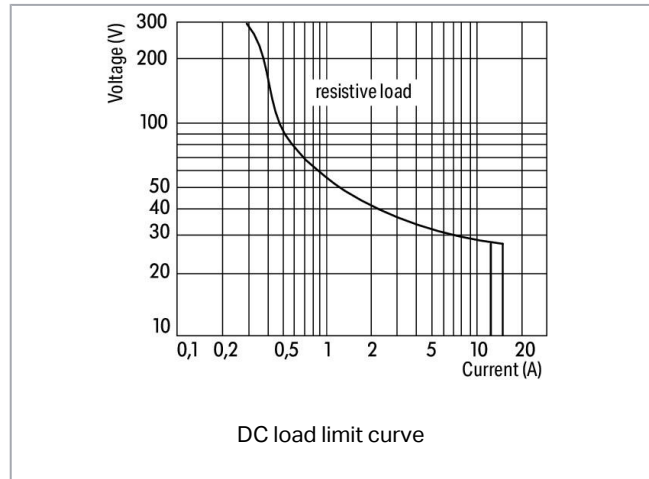

[www.wago.com/2042-3839](http://www.wago.com/2042-3839)

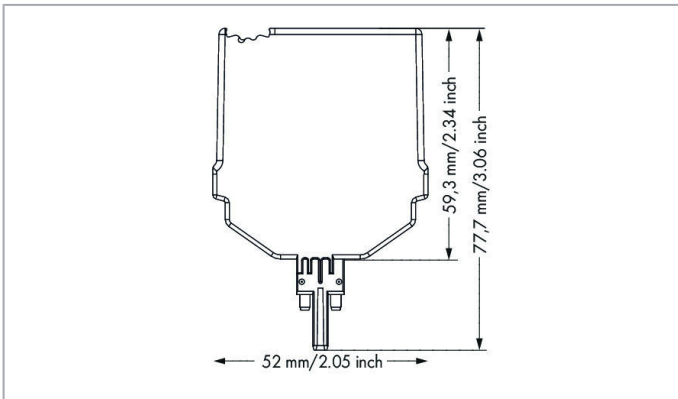
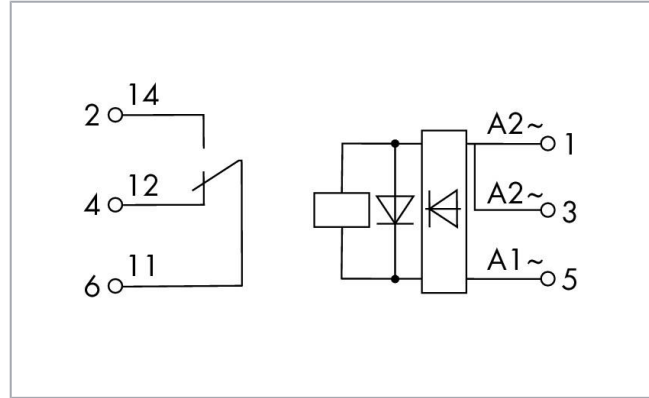
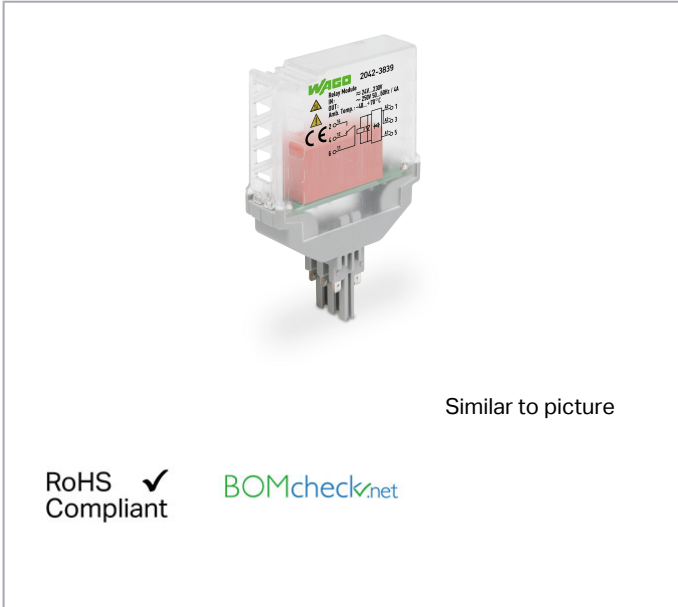

### Data

#### Technical data

#### Control circuit

Nominal input voltage  $U_N$

AC/DC 24 ... 230 V

Subject to changes. Please also observe the further product documentation!

WAGO Kontakttechnik GmbH & Co. KG  
Hansastr. 27  
32423 Minden  
Phone: +49571 887-0 | Fax: +49571 887-169  
Email: [info.de@wago.com](mailto:info.de@wago.com) | Web: [www.wago.com](http://www.wago.com)

Do you have any questions about our products?  
We are always happy to take your call at +49 (571) 887-44222.



Input voltage range	±10 %
Nominal input current at $U_N$	6 mA (230 V); 50.2 mA (24 V)

### Load circuit

Number of changeover/switchover contacts	1
Contact material (relay)	AgNi
Limiting continuous current	4 A
Inrush current (resistive) (max.)	(AC) 30 A / 4 s
Switching voltage (max.)	AC 250 V
Switching power (resistive) (max.)	AC 1000 VA; DC (see load limit curve)
Switching capacity	AC-15: 6 A / AC 250 V; DC-13: 2 A / DC 24 V
Recommended minimum load	12 V / 10 mA
Pull-in time (typ.)	8 ms
Drop-out time (typ.)	6 ms
Bounce time (typ.)	4 ms
Electrical life (NO; resistive load; 23 °C)	100 x 10 <sup>3</sup> switching operations
Mechanical life	10 x 10 <sup>6</sup> switching operations

### Signaling

Status indicator	Green LED
------------------	-----------

### Safety and protection

Rated voltage	250 V
Pollution degree	2
Dielectric strength, control/load circuit (AC, 1 min)	3 kVrms
Dielectric strength, open contact (AC, 1 min)	1 kVrms
Protection type	IP20

### Physical data

Width	15.5 mm / 0.61 inch
Height	77.7 mm / 3.059 inch
Height from the surface	59.3 mm / 2.335 inch
Depth	52 mm / 2.047 inch

Subject to changes. Please also observe the further product documentation!

WAGO Kontakttechnik GmbH & Co. KG  
 Hansastr. 27  
 32423 Minden  
 Phone: +49571 887-0 | Fax: +49571 887-169  
 Email: [info.de@wago.com](mailto:info.de@wago.com) | Web: [www.wago.com](http://www.wago.com)

Do you have any questions about our products?  
 We are always happy to take your call at +49 (571) 887-44222.

## Mechanical data

Mounting type	Pluggable module for TOPJOB® S carrier terminal block
---------------	---

## Material data

Flammability class per UL94	V0
Weight	36.3 g

## Environmental requirements

Surrounding air temperature (operation at $U_N$ )	-40 ... 70 °C
Surrounding air temperature (storage)	-40 ... 85 °C
Processing temperature	-25 ... +50 °C
Operating altitude (max.)	2000 m

## Standards and specifications

Standards/Specifications	EN 61010-2-201; EN 61373; EN 50121-3-2
--------------------------	--

## Commercial data

Packaging type	BOX
Country of origin	DE
GTIN	4055143651943
Customs tariff number	85364900990

## Approvals / Certificates

### UL-Approvals















Logo	Approval	Additional Approval Text	Certificate name
	UL Underwriters Laboratories Inc. (ORDINARY LOCATIONS)	UL 61010-1	E175199

## Compatible products

### Marking accessories

Item no.: 2009-110

Subject to changes. Please also observe the further product documentation!

	Marking strips; for Smart Printer; on reel; not stretchable; plain; snap-on type; white	<a href="http://www.wago.com/2009-110">www.wago.com/2009-110</a>
	<b>Item no.: 2009-115</b> WMB-Inline; for Smart Printer; 1500 pieces on roll; stretchable 5 - 5.2 mm; plain; snap-on type; white	<a href="http://www.wago.com/2009-115">www.wago.com/2009-115</a>
	<b>Item no.: 2009-115/000-002</b> WMB-Inline; for Smart Printer; 1500 pieces on roll; stretchable 5 - 5.2 mm; plain; snap-on type; yellow	<a href="http://www.wago.com/2009-115/000-002">www.wago.com/2009-115/000-002</a>
	<b>Item no.: 2009-115/000-006</b> WMB-Inline; for Smart Printer; 1500 pieces on roll; stretchable 5 - 5.2 mm; plain; snap-on type; blue	<a href="http://www.wago.com/2009-115/000-006">www.wago.com/2009-115/000-006</a>
	<b>Item no.: 2009-115/000-007</b> WMB-Inline; for Smart Printer; 1500 pieces on roll; stretchable 5 - 5.2 mm; plain; snap-on type; gray	<a href="http://www.wago.com/2009-115/000-007">www.wago.com/2009-115/000-007</a>
	<b>Item no.: 2009-115/000-012</b> WMB-Inline; for Smart Printer; 1500 pieces on roll; stretchable 5 - 5.2 mm; plain; snap-on type; orange	<a href="http://www.wago.com/2009-115/000-012">www.wago.com/2009-115/000-012</a>
	<b>Item no.: 2009-115/000-017</b> WMB-Inline; for Smart Printer; 1500 pieces on roll; stretchable 5 - 5.2 mm; plain; snap-on type; light green	<a href="http://www.wago.com/2009-115/000-017">www.wago.com/2009-115/000-017</a>
	<b>Item no.: 2009-115/000-023</b> WMB-Inline; for Smart Printer; 1500 pieces on roll; stretchable 5 - 5.2 mm; plain; snap-on type; green	<a href="http://www.wago.com/2009-115/000-023">www.wago.com/2009-115/000-023</a>
	<b>Item no.: 2009-115/000-024</b> WMB-Inline; for Smart Printer; 1500 pieces on roll; stretchable 5 - 5.2 mm; plain; snap-on type; violet	<a href="http://www.wago.com/2009-115/000-024">www.wago.com/2009-115/000-024</a>
	<b>Item no.: 793-501</b> WMB marking card; as card; not stretchable; plain; snap-on type; white	<a href="http://www.wago.com/793-501">www.wago.com/793-501</a>
	<b>Item no.: 793-501/000-002</b> WMB marking card; as card; not stretchable; plain; snap-on type; yellow	<a href="http://www.wago.com/793-501/000-002">www.wago.com/793-501/000-002</a>
	<b>Item no.: 793-501/000-005</b> WMB marking card; as card; not stretchable; plain; snap-on type; red	<a href="http://www.wago.com/793-501/000-005">www.wago.com/793-501/000-005</a>
	<b>Item no.: 793-501/000-006</b> WMB marking card; as card; not stretchable; plain; snap-on type; blue	<a href="http://www.wago.com/793-501/000-006">www.wago.com/793-501/000-006</a>
	<b>Item no.: 793-501/000-007</b> WMB marking card; as card; not stretchable; plain; snap-on type; gray	<a href="http://www.wago.com/793-501/000-007">www.wago.com/793-501/000-007</a>

Subject to changes. Please also observe the further product documentation!



**Item no.: 793-501/000-012**  
WMB marking card; as card; not stretchable; plain; snap-on type; orange

[www.wago.com/793-501/000-012](http://www.wago.com/793-501/000-012)



**Item no.: 793-501/000-017**  
WMB marking card; as card; not stretchable; plain; snap-on type; light green

[www.wago.com/793-501/000-017](http://www.wago.com/793-501/000-017)



**Item no.: 793-501/000-023**  
WMB marking card; as card; not stretchable; plain; snap-on type; green

[www.wago.com/793-501/000-023](http://www.wago.com/793-501/000-023)



**Item no.: 793-501/000-024**  
WMB marking card; as card; not stretchable; plain; snap-on type; violet

[www.wago.com/793-501/000-024](http://www.wago.com/793-501/000-024)



**Item no.: 793-5501**  
WMB marking card; as card; for terminal block width 5 - 17.5 mm; stretchable 5 - 5.2 mm; plain; snap-on type; white

[www.wago.com/793-5501](http://www.wago.com/793-5501)



**Item no.: 793-5501/000-002**  
WMB marking card; as card; for terminal block width 5 - 17.5 mm; stretchable 5 - 5.2 mm; plain; snap-on type; yellow

[www.wago.com/793-5501/000-002](http://www.wago.com/793-5501/000-002)



**Item no.: 793-5501/000-005**  
WMB marking card; as card; for terminal block width 5 - 17.5 mm; stretchable 5 - 5.2 mm; plain; snap-on type; red

[www.wago.com/793-5501/000-005](http://www.wago.com/793-5501/000-005)



**Item no.: 793-5501/000-006**  
WMB marking card; as card; for terminal block width 5 - 17.5 mm; stretchable 5 - 5.2 mm; plain; snap-on type; blue

[www.wago.com/793-5501/000-006](http://www.wago.com/793-5501/000-006)



**Item no.: 793-5501/000-007**  
WMB marking card; as card; for terminal block width 5 - 17.5 mm; stretchable 5 - 5.2 mm; plain; snap-on type; gray

[www.wago.com/793-5501/000-007](http://www.wago.com/793-5501/000-007)



**Item no.: 793-5501/000-012**  
WMB marking card; as card; for terminal block width 5 - 17.5 mm; stretchable 5 - 5.2 mm; plain; snap-on type; orange

[www.wago.com/793-5501/000-012](http://www.wago.com/793-5501/000-012)



**Item no.: 793-5501/000-014**  
WMB marking card; as card; for terminal block width 5 - 17.5 mm; stretchable 5 - 5.2 mm; plain; snap-on type; brown

[www.wago.com/793-5501/000-014](http://www.wago.com/793-5501/000-014)



**Item no.: 793-5501/000-017**  
WMB marking card; as card; for terminal block width 5 - 17.5 mm; stretchable 5 - 5.2 mm; plain; snap-on type; green

[www.wago.com/793-5501/000-017](http://www.wago.com/793-5501/000-017)



**Item no.: 793-5501/000-023**  
WMB marking card; as card; for terminal block width 5 - 17.5 mm; stretchable 5 - 5.2 mm; plain; snap-on type; light green

[www.wago.com/793-5501/000-023](http://www.wago.com/793-5501/000-023)







**Item no.: 793-5501/000-024**  
WMB marking card; as card; for terminal block width 5 - 17.5 mm; stretchable 5 - 5.2 mm; plain; snap-on type

[www.wago.com/793-5501/000-024](http://www.wago.com/793-5501/000-024)





Subject to changes. Please also observe the further product documentation!

type; violet

## clamps

	<b>Item no.: 2002-1661</b> 2-conductor carrier terminal block; for DIN-rail 35 x 15 and 35 x 7.5; 2.5 mm <sup>2</sup> ; Push-in CAGE CLAMP®; 2,50 mm <sup>2</sup> ; gray	<a href="http://www.wago.com/2002-1661">www.wago.com/2002-1661</a>
	<b>Item no.: 2002-1761</b> 3-conductor carrier terminal block; for DIN-rail 35 x 15 and 35 x 7.5; 2.5 mm <sup>2</sup> ; Push-in CAGE CLAMP®; 2,50 mm <sup>2</sup> ; gray	<a href="http://www.wago.com/2002-1761">www.wago.com/2002-1761</a>
	<b>Item no.: 2002-1861</b> 4-conductor carrier terminal block; for DIN-rail 35 x 15 and 35 x 7.5; 2.5 mm <sup>2</sup> ; Push-in CAGE CLAMP®; 2,50 mm <sup>2</sup> ; gray	<a href="http://www.wago.com/2002-1861">www.wago.com/2002-1861</a>
	<b>Item no.: 2002-1961</b> 2-conductor carrier terminal block; with additional jumper position; for DIN-rail 35 x 15 and 35 x 7.5; 2.5 mm <sup>2</sup> ; Push-in CAGE CLAMP®; 2,50 mm <sup>2</sup> ; gray	<a href="http://www.wago.com/2002-1961">www.wago.com/2002-1961</a>

## End plate

	<b>Item no.: 2002-1691</b> End and intermediate plate; 1 mm thick; gray	<a href="http://www.wago.com/2002-1691">www.wago.com/2002-1691</a>
	<b>Item no.: 2002-1692</b> End and intermediate plate; 1 mm thick; orange	<a href="http://www.wago.com/2002-1692">www.wago.com/2002-1692</a>
	<b>Item no.: 2002-1791</b> End and intermediate plate; 1 mm thick; gray	<a href="http://www.wago.com/2002-1791">www.wago.com/2002-1791</a>
	<b>Item no.: 2002-1792</b> End and intermediate plate; 1 mm thick; orange	<a href="http://www.wago.com/2002-1792">www.wago.com/2002-1792</a>
	<b>Item no.: 2002-1891</b> End and intermediate plate; 1 mm thick; gray	<a href="http://www.wago.com/2002-1891">www.wago.com/2002-1891</a>
	<b>Item no.: 2002-1892</b> End and intermediate plate; 1 mm thick; orange	<a href="http://www.wago.com/2002-1892">www.wago.com/2002-1892</a>

## Downloads

## Documentation

## Bid Text

2042-3839 X81 - Datei	19. 2. 2019	xml 3.9 kB	Download
2042-3839 docx - Datei	20. 2. 2019	docx 17.3 kB	Download

## Instruction Leaflet

Pluggable Relay Module / Pluggable Solid-State Relay Module	V 1.1.0	pdf 2.0 MB	Download
---	---------	---------------	----------

Subject to changes. Please also observe the further product documentation!



#### Additional Information

Disposal; Electrical and electronic equipment, Packaging	V 1.0.0	pdf 265.8 kB	Download
--	---------	-----------------	----------

---

#### CAD/CAE-Data

##### CAD data

2D/3D Models 2042-3839	URL	Download
------------------------	-----	----------

---

##### CAE data

ZUKEN Portal 2042-3839	URL	Download
------------------------	-----	----------

---

#### Environmental Product Compliance

##### Compliance Search

Environmental Product Compliance 2042-3839 Relay module; Nominal input voltage: 24 ... 230 V AC/DC; 1 changeover contact; Limiting continuous current: 4 A; Green status indicator; Module width: 15 mm	URL	Download
---	-----	----------

---

#### Installation Notes

Subject to changes. Please also observe the further product documentation!