

DISPLAY Elektronik GmbH

DATA SHEET

TFT MODULE

**DEM 480272G2 VMX-PW-N
(C2-TOUCH)**

Product Specification

Version: 0

18.12.2023

GENERAL SPECIFICATION

MODULE NO. :

DEM 480272G2 VMX-PW-N
(C2-TOUCH)

CUSTOMER

VERSION NO.	CHANGE DESCRIPTION	DATE
0	Original Version	18.12.2023

PREPARED BY: LM

DATE: 18.12.2023

APPROVEDBY: WH

DATE: 18.12.2023

CONTENTS

1. GENERAL SPECIFICATIONS	2
2. EXTERNAL DIMENSIONS	4
3. BLOCK DIAGRAM.....	5
4. PIN ASSIGNMENT.....	6
5. OPTICAL CHARACTERISTICS	8
6. ABSOLUTE MAXIMUM RATINGS	11
7. ELECTRICAL CHARACTERISTICS	12
8. TIMING CHARACTERISTICS	13
9. RELIABILITY TEST	17
10. LCD MODULES HANDLING PRECAUTIONS.....	18
11. OTHERS.....	18

1. GENERAL SPECIFICATIONS

ITEM	STANDARD VALUE	UNIT
LCD TYPE	TFT/IPS/NORMALLY BLACK/TRANSMISSIVE	
MODULE SIZE(W*H*T)	105.50 x 67.20 x 4.35	mm
ACTIVE SIZE(W*H)	95.04 x 53.856	mm
PIXEL PITCH(W*H)	0.198 x 0.198	mm
NUMBER OF DOTS	480 x 272	
DRIVER IC	SC7283-G4	
INTERFACE TYPE	24 BIT RGB	
FRONT POLARIZER	ANTI GLARE	
RECOMMENG VIEWING DIRECTION	ALL	O'clock
GRAY SCALE INVERSION DIRECTION	-	O'clock
COLORS	16.7 M	
BACKLIGHT TYPE	5S2P (TOTAL 10 WHITE LONG LIFETIME LED)	
TOUCH PANEL TYPE	CTP	

TOUCH PANEL:

Item	Contents
Type	Capacitive Multi-touch
Module size	105.50 mm x 67.20 mm x 1.35mm
View area	96.04 mm x 54.856 mm
Driver IC	FT5426G
Interface	I2C
Operation Voltage	2.7V~3.6V
ITO Glass thickness	0.4mm
Operation humidity	20~90%RH
Storage humidity	20~90%RH
Resolution	480*272
Input force	≤10g
Temperature Operation	-30°C to +85°C
Temperature Storage	-30°C to +85°C
Input method	Finger or exclusive pen
Transparency	≥88%
Surface hardness	>6H
Hitting life	>35,000,000 times
Insulation	20M ohm or over(Dc 25V)
ESD(Human body model)	2,000 V

2. EXTERNAL DIMENSIONS

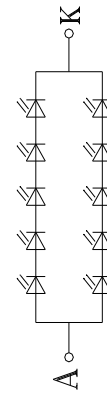
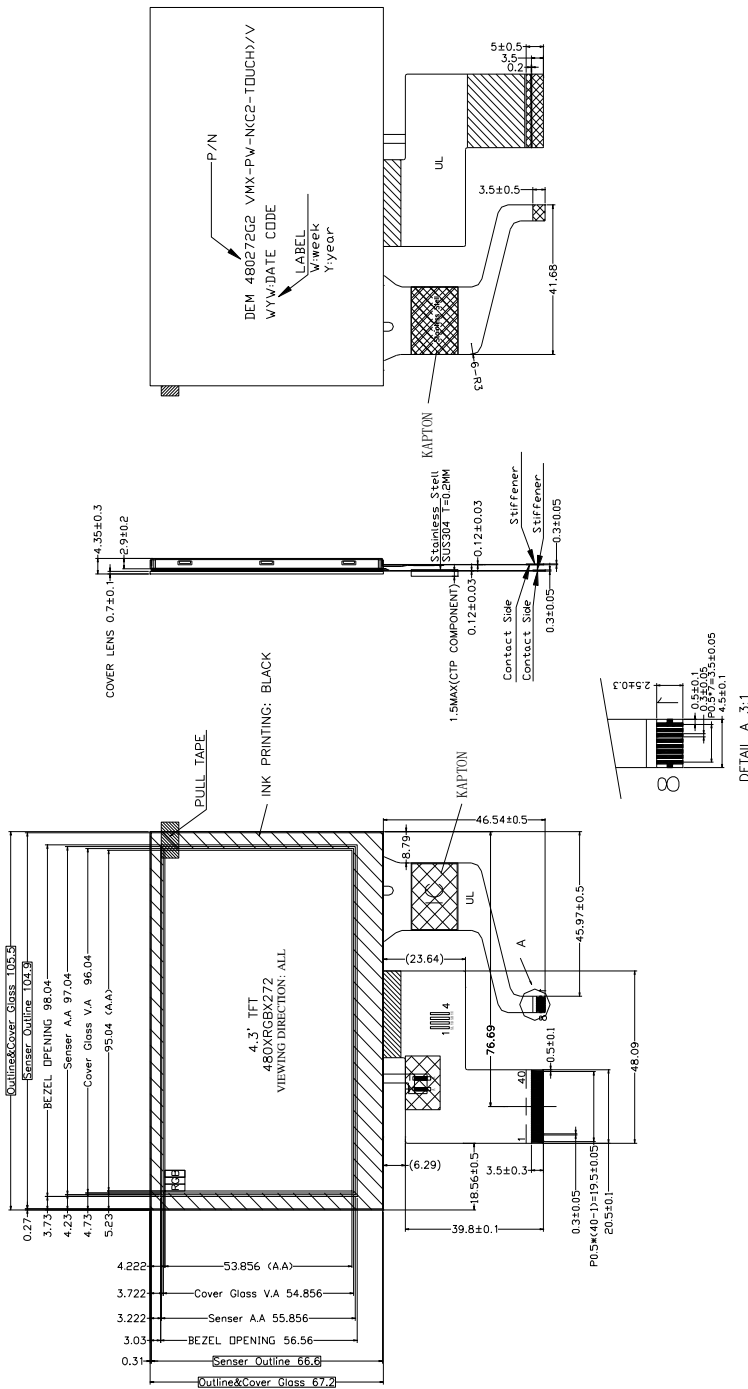

LED CIRCUIT DIAGRAM

40mA@ 13.5V~17V

10 PCS WHITE LED

Brightness 650cd/m²(MIN)

Remark:

1. Unmarked tolerance is ±0.3
2. All materials comply with RoHS
3. []:critical dimension.
4. LED Lifetime:50000h.

3. BLOCK DIAGRAM

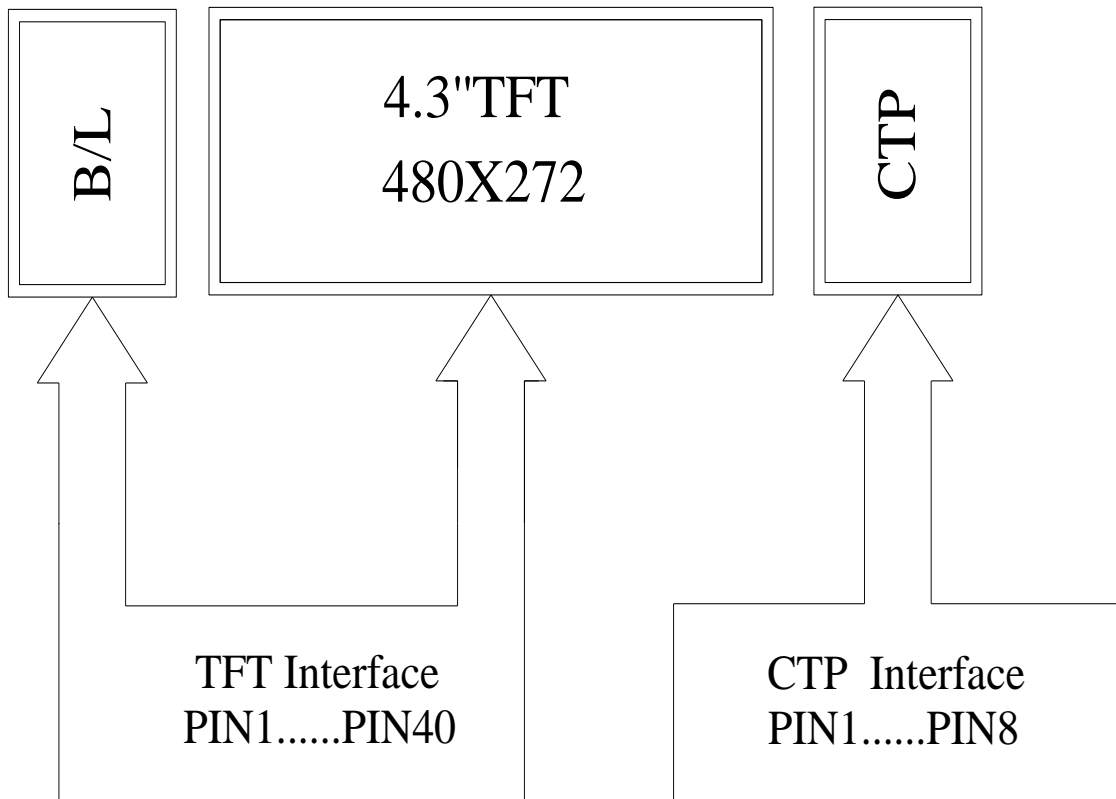

4. PIN ASSIGNMENT

Pin No.	Symbol	Description
1	LEDK	Backlight Cathode
2	LEDA	Backlight Anode
3	GND	Power ground
4	VDD	Logic power supply(3.3V)
5	R0	Red data (LSB)
6	R1	Red data
7	R2	Red data
8	R3	Red data
9	R4	Red data
10	R5	Red data
11	R6	Red data
12	R7	Red data (MSB)
13	G0	Green data (LSB)
14	G1	Green data
15	G2	Green data
16	G3	Green data
17	G4	Green data
18	G5	Green data
19	G6	Green data
20	G7	Green data (MSB)
21	B0	Blue data (LSB)
22	B1	Blue data
23	B2	Blue data
24	B3	Blue data
25	B4	Blue data
26	B5	Blue data
27	B6	Blue data
28	B7	Blue data (MSB)
29	GND	Power ground
30	CLK	Pixel clock
31	DISP	Display on/off
32	HSYNC	Horizontal sync signal
33	VSYNC	Vertical sync signal

DEM 480272G2 VMX-PW-N(C2-TOUCH) Product Specification

34	DE	Data Enable
35	NC	No connection
36	GND	Power ground
37	NC	No connection
38	NC	No connection
39	NC	No connection
40	NC	No connection

Touch Panel:

Pin No.	Symbol	Description
1	GND	Negative supply
2	I2C_SCL	I2C Serial clock input/output
3	I2C_SDA	I2C Serial data input/output
4	INT	External Interrupt
5	RST	External Reset, Low is active
6	VCC	Power supply of CTP(3.3V)
7	AVDD	Power supply of CTP(3.3V)
8	NC	No connection

5. OPTICAL CHARACTERISTICS

ITEM		SYMBOL	CONDITIONS	SPECIFICATIONS			UNIT	NOTE
				MIN	TYP.	MAX		
Luminance		L	Il=40mA	650			Cd/m ²	
Contrast ratio		CR	θ =0° VIEWING NORMAL ANGLE	640	800			
Response time		Ton + Toff			30	40	ms	
CIE COLOUR COORDINATE	RED	XR			0.629			
		YR			0.326			
	GREEN	XG			0.337			
		YG			0.546			
	BLUE	XB			0.136			
		YB			0.143			
	WHITE	XW			0.320			
		YW			0.345			
VIEWING ANGLE	Hor.	θ _{x+}	CR ≥ 10	70	80		Degree	
		θ _{x-}		70	80			
	Ver.	θ _{y+}		70	80			
		θ _{y-}		70	80			

Note 1: Definition of Viewing Angle θ_x and θ_y :

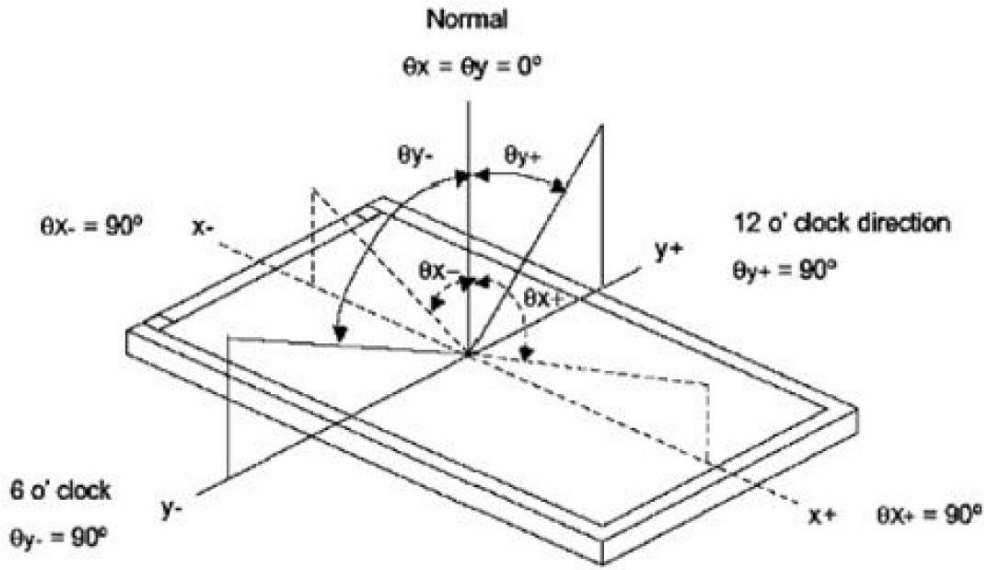

Note 2: Definition of contrast ratio CR:

$$CR = \frac{\text{Luminance of white state}}{\text{Luminance of black state}}$$

Note 3: Definition of Response Time (T_r, T_f)

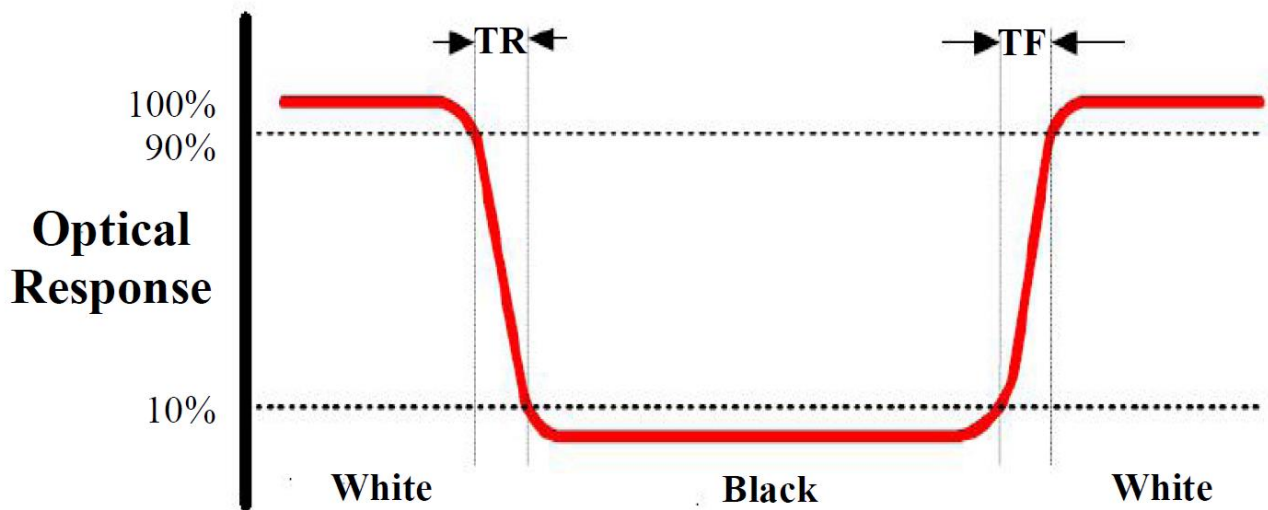

Note 4: Definition of Luminance

① The Brightness Test Equipment Setup

Field=2° (As measuring “black” image, field=2° is the best testing condition)

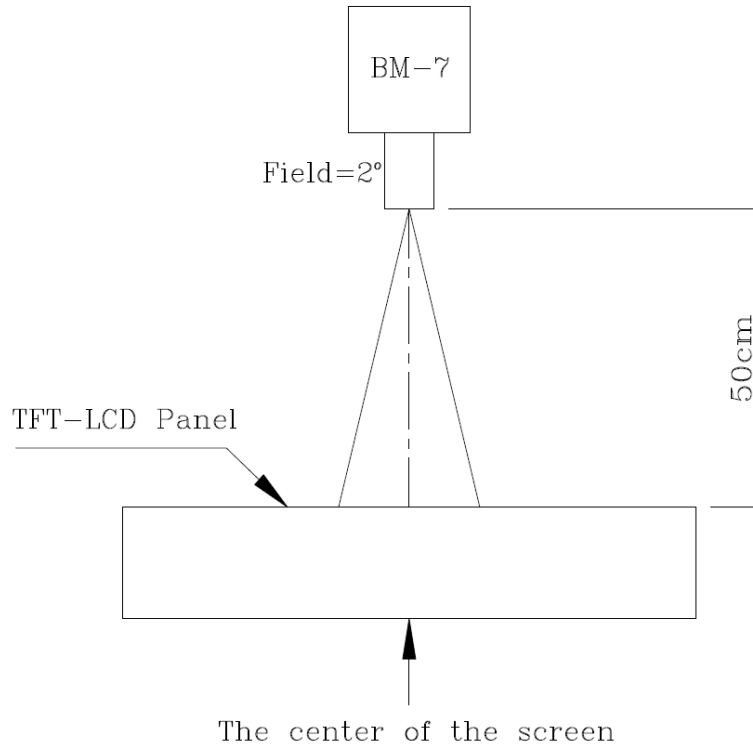

② The Brightness Test Point Setup

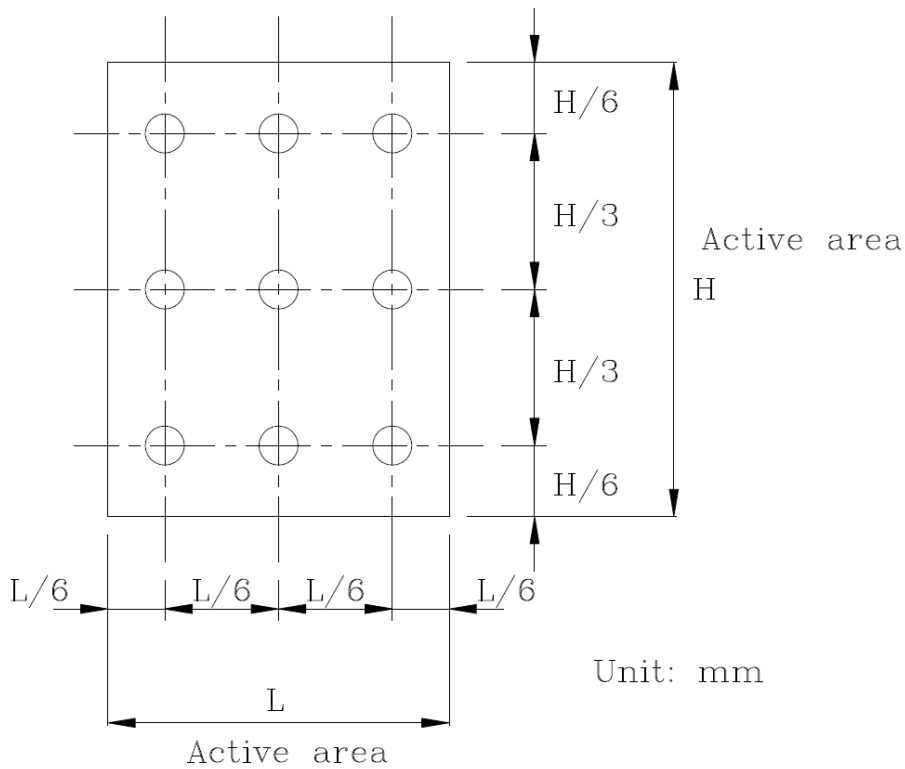

6. ABSOLUTE MAXIMUM RATINGS

PARAMETER	SYMBOL	MIN	MAX	UNIT
Power Supply Voltage	VDD	-0.3	4.0	V
IO Supply Voltage	VDDI	-0.3	4.0	V
Supply current(one LED)	I(LED)		30	mA
Operating temperature	Top	-30	+85	°C
Storage temperature	Tst	-30	+85	°C

Note: The absolute maximum rating values of this product are not allowed to be exceeded at any times. Should a module be used with any of the absolute maximum ratings exceeded, the characteristics of the module may not be recovered, or in an extreme case, the module may be permanently destroyed.

7. ELECTRICAL CHARACTERISTICS**7.1 Input Power**

ITEM	SYMBOL	MIN	TYP.	MAX	UNIT
Power Supply Voltage	VDD	3.0	3.3	3.6	V
IO Supply Voltage	VDDI	3.0	3.3	3.6	V
Input voltage	Vil	GND	-	0.3VDDI	V
	Vih	0.7VDDI	-	VDDI	V

7.2 Backlight Driving Conditions

ITEM	SYMBOL	SPECIFICATIONS			UNIT	REMARK
		MIN	TYP.	MAX		
Voltage for LED backlight	Vf	13.5	15	17	V	I _l =40mA
Current for LED backlight	I _l		40		mA	
Power consumption	P	0.54	0.6	0.68	W	
Led life time			50,000		Hr	Note

Note: brightness to be decreased to 50% of the initial value at ambient temperature TA=25°C

8. TIMING CHARACTERISTICS

8.1 RGB Interface — SYNC Mode

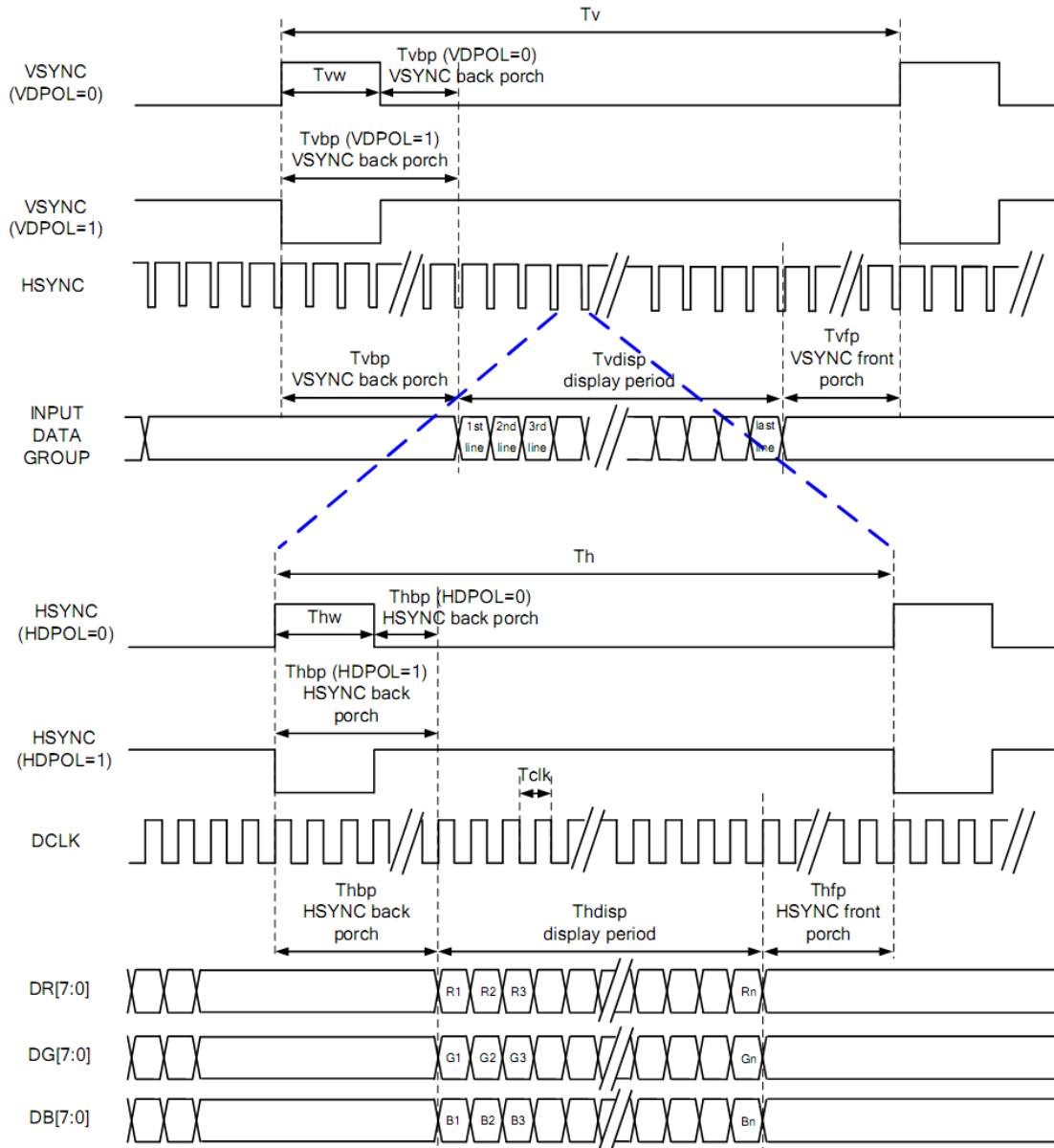

8.2. RGB Interface — SYNC-DE Mode

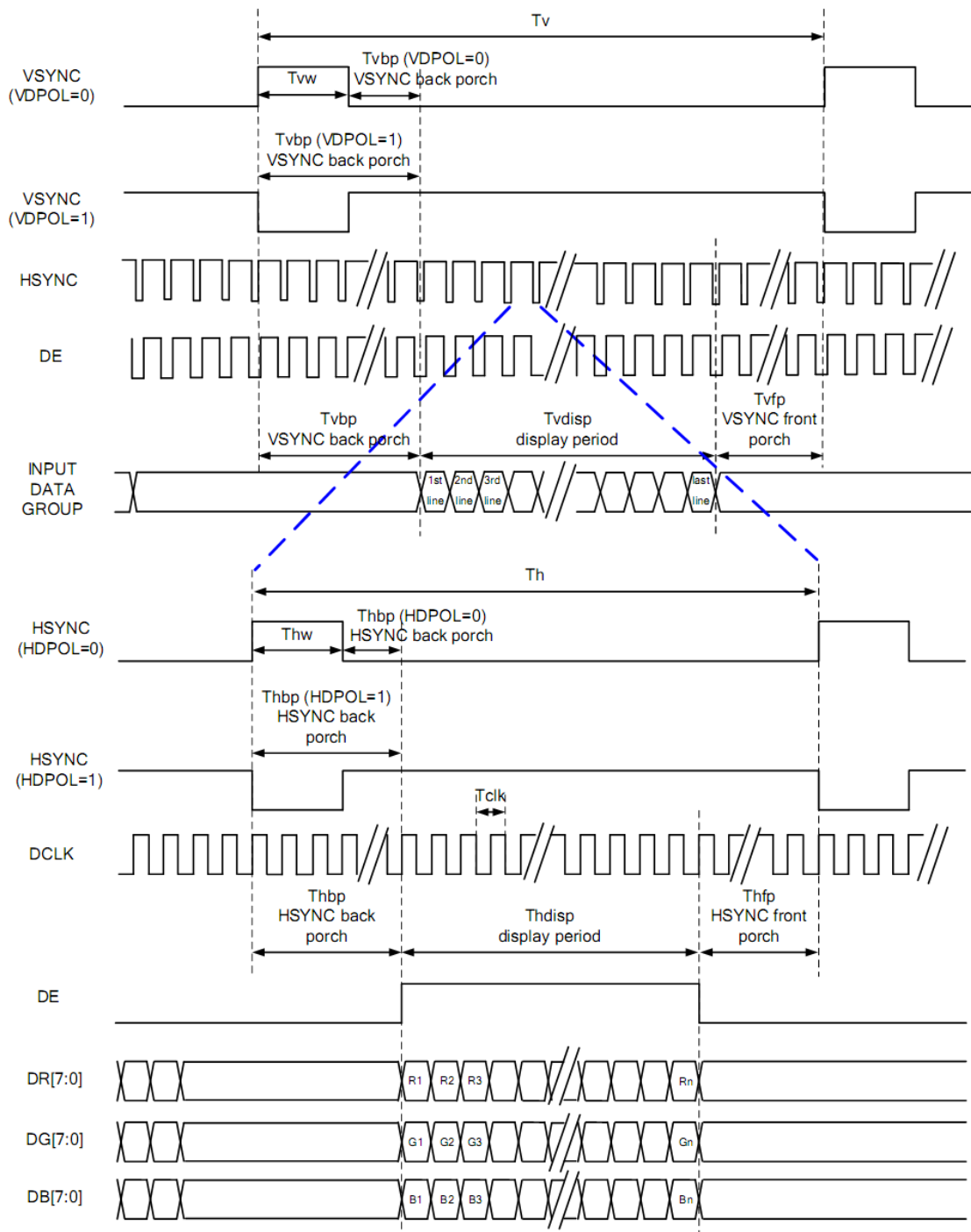

8.3. RGB Interface — DE Mode

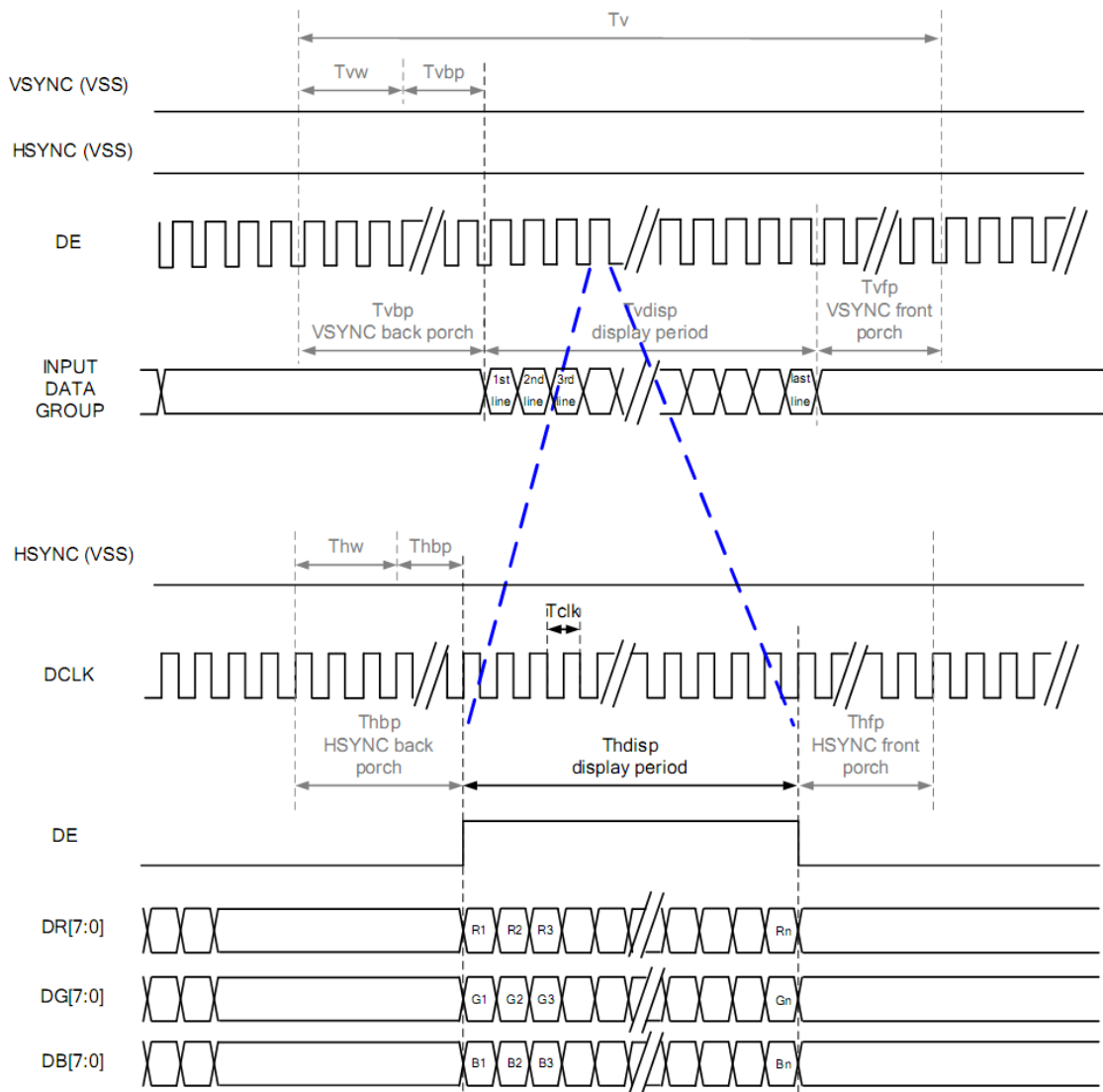

RGB Mode Selection Table	DCLK	HSYNC	VSYNC	DE
SYNC - DE Mode	Input	Input	Input	Input
SYNC Mode	Input	Input	Input	GND
DE Mode	Input	GND	GND	Input

Note: "Input" means these signals are driven by host side.

8.4 Parallel 24 bit RGB Input Timing Table

Parallel 24-bit RGB Input Timing (PVDD=VDD=VDDI= 3.3V, AGND= 0V, TA=25°C)

480RGB X 272 Resolution Timing Table							
Item	Symbol	Min.	Typ.	Max.	Unit	Remark	
DCLK Frequency	Fclk	8	9	12	MHz		
DCLK Period	Tclk	83	111	125	ns		
HSYNC	Period Time	Th	485	531	598	DCLK	
	Display Period	Thdisp		480		DCLK	
	Back Porch	Thbp	3	43	43	DCLK	By H_BLANKING setting
	Front Porch	Thfp	2	8	75	DCLK	
	Pulse Width	Thw	2	4	43	DCLK	
VSYNC	Period Time	Tv	276	292	321	HSYNC	
	Display Period	Tvdisp		272		HSYNC	
	Back Porch	Tvbp	2	12	12	HSYNC	By V_BLANKING setting
	Front Porch	Tvfp	2	8	37	HSYNC	
	Pulse Width	Tvw	2	4	12	HSYNC	

Note: It is necessary to keep Tvbp =12 and Thbp =43 in sync mode. DE mode is unnecessary to keep it.

9. RELIABILITY TEST

NO.	TEST ITEM	DESCRIPTION
1	High temperature operation	Ta=+85°C, 240hrs
2	Low temperature operation	Ta=-30°C, 240hrs
3	High temperature storage	Ta=+85°C, 240hrs
4	Low temperature storage	Ta=-30°C, 240hrs
5	High Temperature and High Humidity (Operating)	Ta=+60°C, 90%RH, 240hrs
6	Electrical Static Discharge	Air: ±8KV, 150pF/330Ω 10time
		Contact: ±4KV 150pF/330Ω 10time

10. LCD MODULES HANDLING PRECAUTIONS

- The display panel is made of glass. Do not subject it to a mechanical shock by dropping it from a high place, etc.
- If the display panel is damaged and the liquid crystal substance inside it leaks out, do not get any in your mouth. If the substance come into contact with your skin or clothes promptly wash it off using soap and water.
- Do not apply excessive force to the display surface or the adjoining areas since this may cause the color tone to vary.
- The polarizer covering the display surface of the LCD module is soft and easily scratched. Handle this polarize carefully.
- To prevent destruction of the elements by static electricity, be careful to maintain an optimum work environment.
 - Be sure to ground the body when handling the LCD module.
 - Tools required for assembly, such as soldering irons, must be properly grounded.
 - To reduce the amount of static electricity generated, do not conduct assembly and other work under dry conditions.
 - The LCD module is coated with a film to protect the display surface. Exercise care when peeling off this protective film since static electricity may be generated.
- Storage precautions
When storing the LCD modules, avoid exposure to direct sunlight or to the light of fluorescent lamps. Keep the modules in bags designed to prevent static electricity charging under low temperature / normal humidity conditions (avoid high temperature / high humidity and low temperatures below 0°C).Whenever possible, the LCD modules should be stored in the same conditions in which they were shipped from our company.

11. OTHERS

- Liquid crystals solidify at low temperature (below the storage temperature range) leading to defective orientation of liquid crystal or the generation of air bubbles (black or white). Air bubbles may also be generated if the module is subjected to a strong shock at a low temperature.
- If the LCD modules have been operating for a long time showing the same display patterns may remain on the screen as ghost images and a slight contrast irregularity may also appear. Abnormal operating status can be resumed to be normal condition by suspending use for some time. It should be noted that this phenomena does not adversely affect performance reliability.
- To minimize the performance degradation of the LCD modules resulting from caused by static electricity, etc. exercise care to avoid holding the following sections when handling the modules:
 - Exposed area of the printed circuit board
 - Terminal electrode sections.