

Data sheet | Item number: 722-739/039-000

THT female header; 0.6 x 1.0 mm solder pin; straight; 100% protected against mismatching; Locking lever; 2.5 mm²; Pin spacing 7.5 mm; 9-pole; light gray

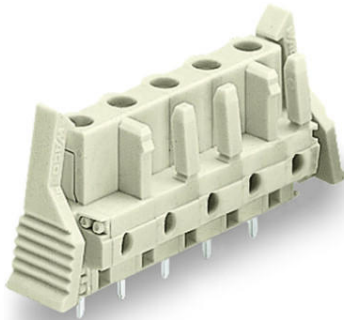

www.wago.com/722-739/039-000



i Picture differs from the item.

RoHS Compliant

Color:

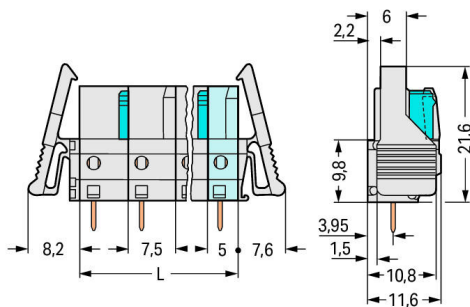
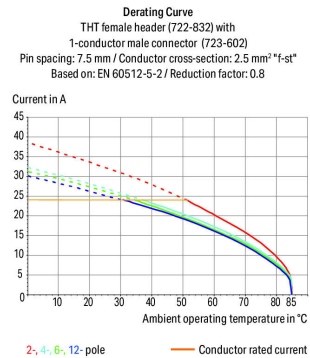

$$L = (\text{pole no.} - 1) \times \text{pin spacing} + 5 \text{ mm} + 1.5 \text{ mm}$$

2-pole female connectors – one latch only

Item description

- Horizontal or vertical PCB mounting via straight or angled solder pins
- For board-to-board and board-to-wire connections

Subject to changes. Please also observe the further product documentation!

WAGO Kontakttechnik GmbH & Co. KG

Hansastr. 27

32423 Minden

Phone: +49571 887-0 | Fax: +49571 887-169

Email: info.de@wago.com | Web: www.wago.com

Do you have any questions about our products?

We are always happy to take your call at +49 (571) 887-44222.



- Touch-proof PCB outputs
- Easy-to-identify PCB inputs and outputs
- 100 % protected against mismatching
- With coding fingers

Safety information 1:

The *MCS – MULTI CONNECTION SYSTEM* includes connectors without breaking capacity in accordance with DIN EN 61984. When used as intended, these connectors must not be connected/disconnected when live or under load. The circuit design should ensure header pins, which can be touched, are not live when unmated.

Data**Electrical data****Ratings per IEC/EN**

Ratings per	IEC/EN 60664-1
Nominal voltage (III/3)	500 V
Rated surge voltage (III/3)	6 kV
Rated voltage (III/2)	630 V
Rated surge voltage (III/2)	6 kV
Nominal voltage (II/2)	1000 V
Rated surge voltage (II/2)	6 kV
Rated current	12 A
Legend (ratings)	(III / 2) $\hat{=}$ Overvoltage category III / Pollution degree 2

Ratings per UL

Approvals per	UL 1059
Rated voltage UL (Use Group B)	300 V
Rated current UL (Use Group B)	15 A
Rated voltage UL (Use Group D)	300 V
Rated current UL (Use Group D)	10 A

Ratings per UL

Rated voltage UL 1977	600 V
Rated current UL 1977	15 A

Ratings per CSA

Approvals per	CSA
---------------	-----

Subject to changes. Please also observe the further product documentation!



Rated voltage CSA (Use Group B)	300 V
Rated current CSA (Use Group B)	15 A
Rated voltage CSA (Use Group D)	300 V
Rated current CSA (Use Group D)	10 A

Connection data

Pole No.	9
Total number of potentials	9
Number of connection types	1
Number of levels	1

Physical data

Pin spacing	7.5 mm / 0.295 inch
Width	80.8 mm / 3.181 inch
Height	26.6 mm / 1.047 inch
Height from the surface	21.6 mm / 0.85 inch
Depth	11.6 mm / 0.457 inch
Solder pin length	5 mm
Solder pin dimensions	0.6 x 1 mm
Drilled hole diameter with tolerance	1.3 ^(+0.1) mm

Plug-in connection

Contact type (pluggable connector)	Female connector/socket
Connector (connection type)	for PCB
Mismating protection	Yes
Mating direction to the PCB	90°
Locking of plug-in connection	locking lever

PCB contact

PCB Contact	THT
Solder pin arrangement	over the entire female connector (in-line)
Number of solder pins per potential	1

Material data

Color	light gray
Material group	I

Subject to changes. Please also observe the further product documentation!

Insulation material	Polyamide (PA66)
Flammability class per UL94	V0
Contact material	Copper alloy
Contact plating	tin-plated
Weight	10.8g

Environmental requirements



Limit temperature range	-60 ... +85 °C
-------------------------	----------------

Commercial data



Packaging type	BOX
Country of origin	DE
GTIN	4055143759540
Customs tariff number	85366990990

Approvals / Certificates

Ship Approvals

Logo	Approval	Additional Approval Text	Certificate name
	ABS American Bureau of Shipping	-	19- HG1869876- PDA
	DNV GL Det Norske Veritas, Germanischer Lloyd	-	TAE000016Z

UL-Approvals

Logo	Approval	Additional Approval Text	Certificate name
	UR Underwriters Laboratories Inc.	UL 1059	E45172
	UR Underwriters Laboratories Inc.	UL 1977	20150318- E45171

Subject to changes. Please also observe the further product documentation!

Counterpart



Item no.723-609

1-conductor male connector; 100% protected against mismatching; 2.5 mm²; Pin spacing 7.5 mm; 9-pole; 2,50 mm²; light gray

www.wago.com/723-609

Downloads

Documentation

Additional Information

Technical explanations	3. 4. 2019	pdf 2.0 MB	Download
------------------------	------------	---------------	----------

CAD/CAE-Data

CAD data

2D/3D Models 722-739/039-000	URL	Download
------------------------------	-----	----------

PCB Design

Symbol and Footprint 722-739/039-000	URL	Download
--------------------------------------	-----	----------

CAX data for your PCB design, consisting of "schematic symbols and PCB footprints", allow easy integration of the WAGO component into your development environment.

Supported formats:

- Accel EDA 14 & 15
- Altium 6 to current version
- Cadence Allegro
- DesignSpark
- Eagle Libraries
- KiCad
- Mentor Graphics BoardStation
- Mentor Graphics Design Architect
- Mentor Graphics Design Expedition 99 and 2000
- OrCAD 9.X PCB and Capture
- PADS PowerPCB 3, 3.5, 4.X, and 5.X
- PADS PowerPCB and PowerLogic 3.0
- PCAD 2000, 2001, 2002, 2004, and 2006
- Pulsonix 8.5 or newer

Subject to changes. Please also observe the further product documentation!

WAGO Kontakttechnik GmbH & Co. KG

Hansastr. 27

32423 Minden

Phone: +49571 887-0 | Fax: +49571 887-169

Email: info.de@wago.com | Web: www.wago.com

Do you have any questions about our products?

We are always happy to take your call at +49 (571) 887-44222.



- STL
- 3D STEP
- TARGET 3001!
- View Logic ViewDraw
- Quadcept
- Zuken CadStar 3 and 4
- Zuken CR-5000 and CR-8000

PCB Component Libraries (EDA), PCB CAD Library Ultra Librarian

CAE data

ZUKEN Portal 722-739/039-000	URL	Download
------------------------------	-----	----------

Environmental Product Compliance

Compliance Search

Environmental Product Compliance 722-739/039-000 THT female header; 0.6 x 1.0 mm solder pin; straight; 100% protected against mismatching; Locking lever; 2.5 mm ² ; Pin spacing 7.5 mm; 9-pole; light gray	URL	Download
---	-----	----------

Installation Notes

Product family

<i>MCS</i> MIDI
[Show all products from the family](#)

Subject to changes. Please also observe the further product documentation!