

AC Filter Cost Optimized



Approvals and Compliances

Description

- Line filter in standard and medical version
- 1-stage
- standard attenuation

Characteristics

- Designed for universal industrial applications
- High attenuation at maximum resp. asymmetric load independent from the line impedance
 Protection against interference voltage from the mains
 Possible interferences generated in the equipment are strongly attenuated
- Especially designed for industrial applications such as: Frequency Converters, Stepper Motor Drives, UPS-Systems, Inverters
- Suitable for use in equipment according to IEC/UL 60950
 Suitable for use in medical equipment according to IEC/UL 60601-1

Other versions on request

- Version with wire connection

References

Alternative: Standard version

Weblinks

[pdf datasheet](#), [html-datasheet](#), [General Product Information](#), [Distributor-Stock-Check](#), [Detailed request for product](#), [Microsite](#)

Technical Data

Ratings IEC	6 - 20A @ Ta 40 °C / 250VAC; 50Hz	Line Filter	Standard and Medical Version, IEC 60939, UL 1283, CSA C22.2 no. 8 Technical Details
Ratings UL/CSA	6 - 20A @ Ta 40 °C / 125VAC; 60Hz	MTBF	> 200'000h acc. to MIL-HB-217 F
Leakage Current	standard < 0.35mA (250V / 60Hz)		
Dielectric Strength	1.7 kVDC between L-N 2.7 kVDC between L/N-PE Test voltage (2 sec)		
Allowable Operation Temperature	-25 °C to 100 °C		
Climatic Category	25/100/21 acc. to IEC 60068-1		
Protection Class	Suitable for appliances with protection class I acc. to IEC 61140		
Terminal	Quick connect terminals 6.3 x 0.8 mm		
Material: Housing	Aluminum		

Approvals and Compliances

Detailed information on product approvals, code requirements, usage instructions and detailed test conditions can be looked up in [Details about Approvals](#)

Approvals







The approval mark is used by the testing authorities to certify compliance with the safety requirements placed on electronic products.

Approval Reference Type: FMLB

Approval Logo	Certificates	Certification Body	Description
	VDE Approvals	VDE	Certificate Number: 40004673
	UL Approvals	UL	UL File Number: E72928



Product standards

Product standards that are referenced

Organization	Design	Standard	Description
	Designed according to	IEC 60320-1	Appliance couplers for household and similar general purposes
	Designed according to	IEC 60939	Passive filters for suppressing electromagnetic interference
	Designed according to	UL 498	Standard for Attachment Plugs and Receptacles
	Designed according to	UL 1283	Electromagnetic interference filters
	Designed according to	CSA C22.2 no. 42	General Use Receptacles, Attachment Plugs, and Similar Wiring Devices
	Designed according to	CSA C22.2 no. 8	Electromagnetic interference (EMI) filters





Application standards

Application standards where the product can be used

Organization	Design	Standard	Description
	Designed for applications acc.	IEC/UL 60950	IEC 60950-1 includes the basic requirements for the safety of information technology equipment.
	Designed for applications acc.	IEC 60601-1	Medical electrical equipment - Part 1: General requirements for basic safety and essential performance

Compliances

The product complies with following Guide Lines

Identification	Details	Initiator	Description
	CE declaration of conformity	SCHURTER AG	The CE marking declares that the product complies with the applicable requirements laid down in the harmonisation of Community legislation on its affixing in accordance with EU Regulation 765/2008.
	RoHS	SCHURTER AG	EU Directive RoHS 2011/65/EU
	China RoHS	SCHURTER AG	The law SJ / T 11363-2006 (China RoHS) has been in force since 1 March 2007. It is similar to the EU directive RoHS.
	REACH	SCHURTER AG	On 1 June 2007, Regulation (EC) No 1907/2006 on the Registration, Evaluation, Authorization and Restriction of Chemicals 1 (abbreviated as "REACH") entered into force.
	Medical Equipment	SCHURTER AG	Suitable for use in medical equipment according to IEC/UL 60601-1

Dimension [mm]

Case 49

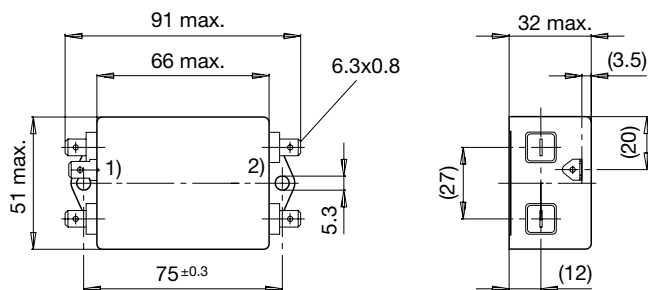

- 1) Line
- 2) Load

Diagrams

Standard version

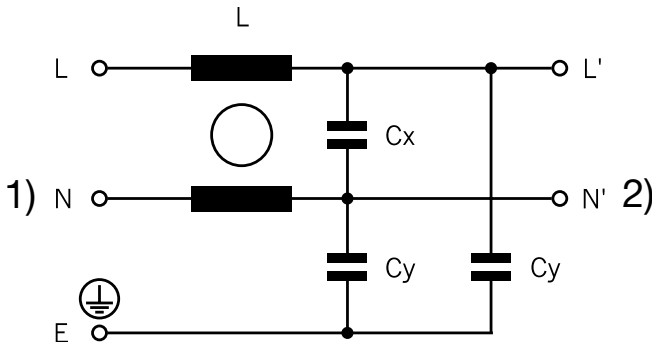

1) Line
 2) Load

Medical version (M5)

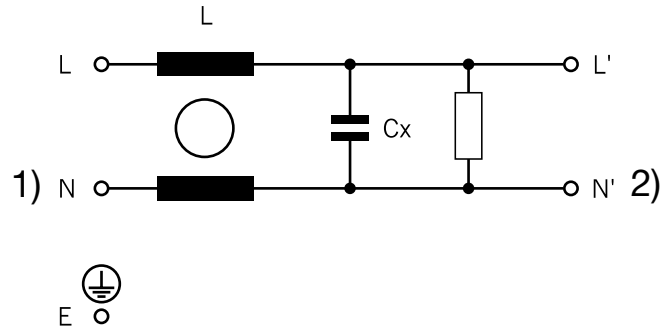

1) Line
 2) Load

Medical version (M80)

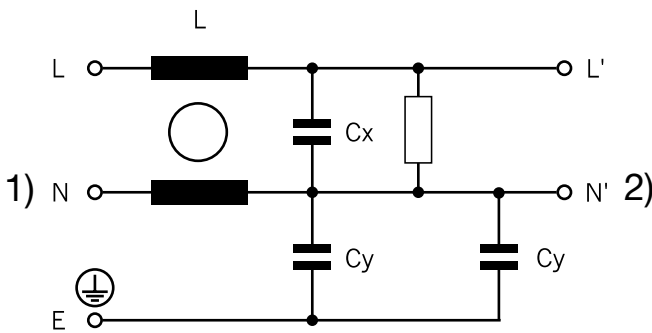

1) Line
 2) Load

Attenuation Loss

----- 50Ω differential mode _____ 50Ω common mode

Standard version

6 A

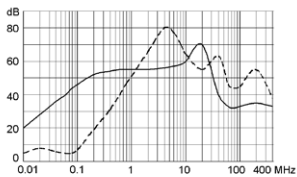

10 A

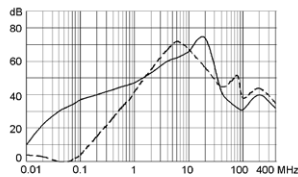

16 A

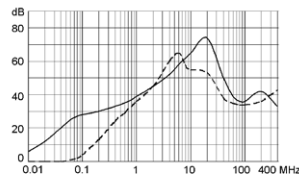

20 A

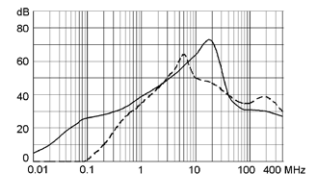

Medical version (M5)

6 A

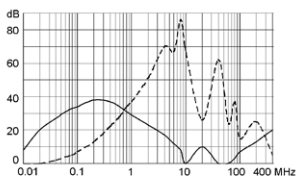

10 A

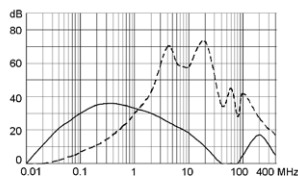

16 A

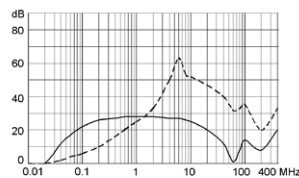

20 A

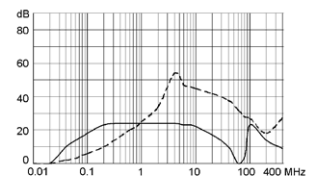

Medical version (M80)

6 A

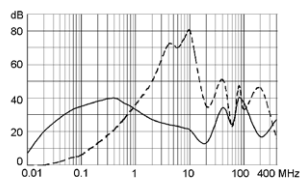

10 A

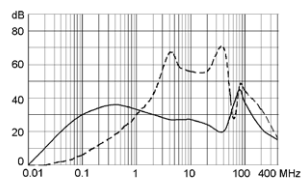

16 A

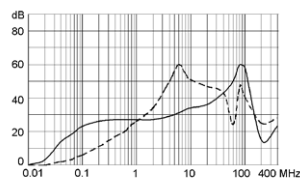

20 A

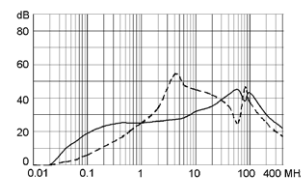

All Variants

Rated Current [A]	Filter-Type	L [mH]	Cx (X2) [µF]	Cy (Y2) [nF]	Weight [g]	Housings	Order Number
6	Standard Version	2 x 14	0.1	3.3	212 g	49	5500.2035
10	Standard Version	2 x 5	0.1	3.3	212 g	49	5500.2036
16	Standard Version	2 x 2	0.1	3.3	208 g	49	5500.2037
20	Standard Version	2 x 1.5	0.1	3.3	218 g	49	5500.2038
6	Medical Version (M5)	2 x 14	0.1	-	212 g	49	5500.2082
10	Medical Version (M5)	2 x 5	0.1	-	212 g	49	5500.2083
16	Medical Version (M5)	2 x 2	0.1	-	208 g	49	5500.2084
20	Medical Version (M5)	2 x 1.5	0.1	-	218 g	49	5500.2085
6	Medical Version (M80)	2 x 14	0.1	0.47	212 g	49	5500.2094
10	Medical Version (M80)	2 x 5	0.1	0.47	212 g	49	5500.2095
16	Medical Version (M80)	2 x 2	0.1	0.47	208 g	49	5500.2096
20	Medical Version (M80)	2 x 1.5	0.1	0.47	218 g	49	5500.2097

Most Popular.

Availability for all products can be searched real-time: <https://www.schurter.com/en/Stock-Check/Stock-Check-SCHURTER>

Packaging unit 10 Pcs