

THIS DOCUMENT IS THE PROPERTY OF
KEYSTONE ELECTRONICS CORP. AND
SHALL NOT BE REPRODUCED, DISTRIBUTED
OR USED AS A BASIS FOR MANUFACTURE
WITHOUT PRIOR WRITTEN PERMISSION
FROM KEYSTONE ELECTRONICS CORP.

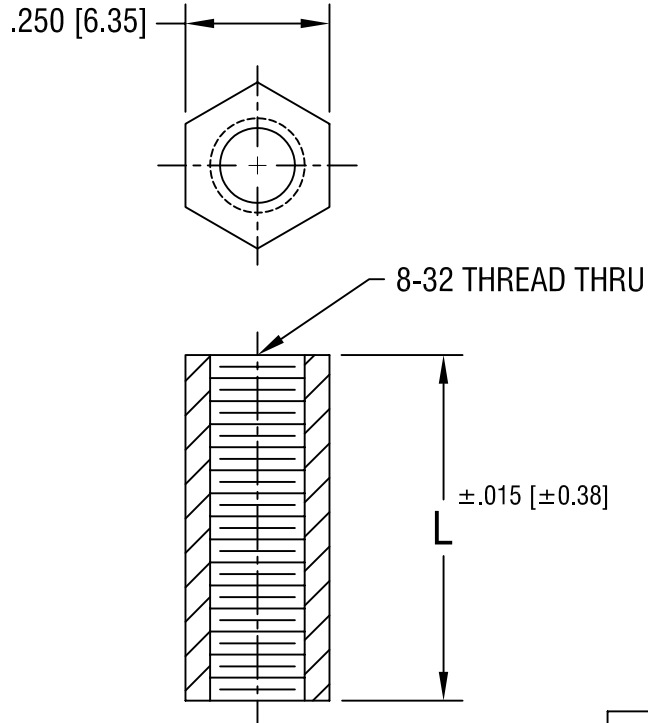

PART NO.	'L' DIM.
8442A	.250 [6.35]
8442B	.375 [9.52]
8442C	.500 [12.70]
8442D	.625 [15.87]
8442E	.750 [19.05]
8442F	.875 [22.22]
8442G	1.000 [25.4]

KEYSTONE ELECTRONICS CORP.

ASTORIA, N.Y. 11105-2017

PART NAME

HEX STANDOFF, FLAME RETARDANT

MATERIAL

NYLON 6/6 UL 94V-0

FINISH

-

DRN BY

BOONE

DATE

1.25.96

APPD

SCALE

3X

TOLERANCES

INCH [MM]

DECIMAL ± .005 [± 0.15]

ANGULAR ± 1°

UNLESS OTHERWISE SPECIFIED

CODE

C/M

DWG NO.

8442-

DATE	DESCRIPTION	REV.