

THIS DRAWING IS UNPUBLISHED. RELEASED FOR PUBLICATION
 © COPYRIGHT - By - ALL RIGHTS RESERVED.

LOC		DIST		REVISIONS			
P	LTR	DESCRIPTION		DATE	DWN	APVD	
AD	00	E		REVISED PER ECO-14-006340	30APR2014	AP	RP

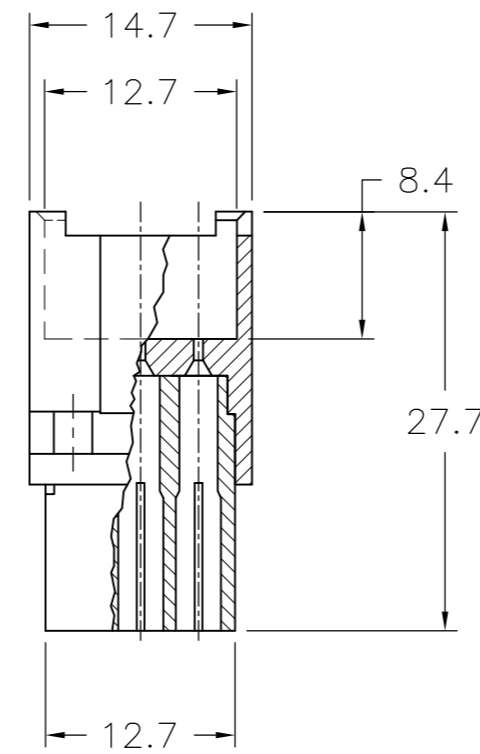

- 1 MATERIAL: 20% GLASS FILLED NORYL, COLOR: GREY RAL 7032.
- 2 BLOCK MARKING AND CAVITY NUMBERS PRINTED IN GREEN COLOR.

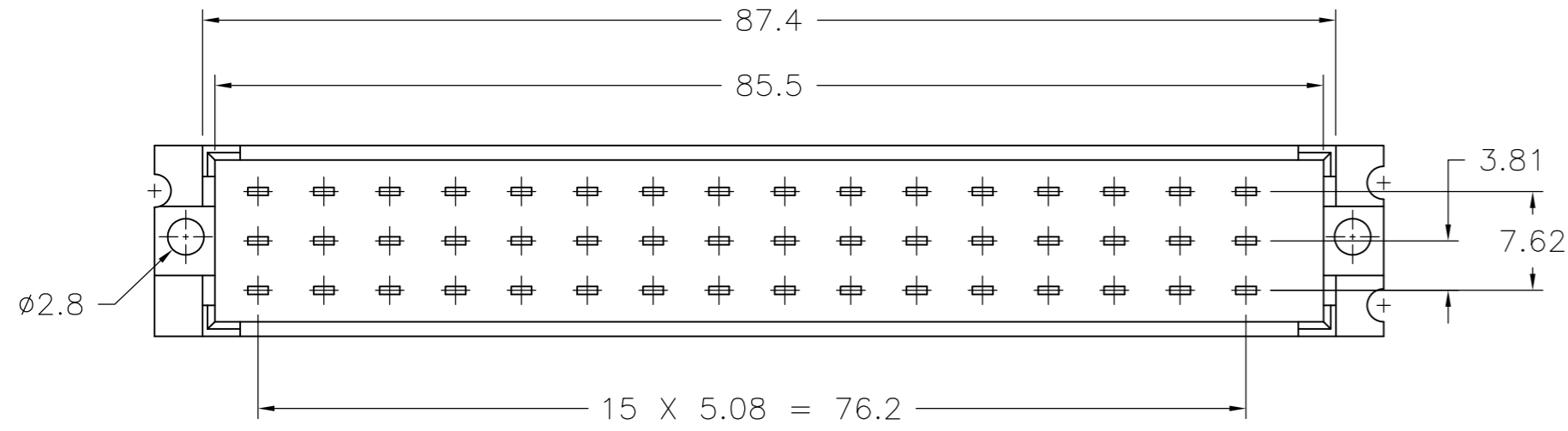
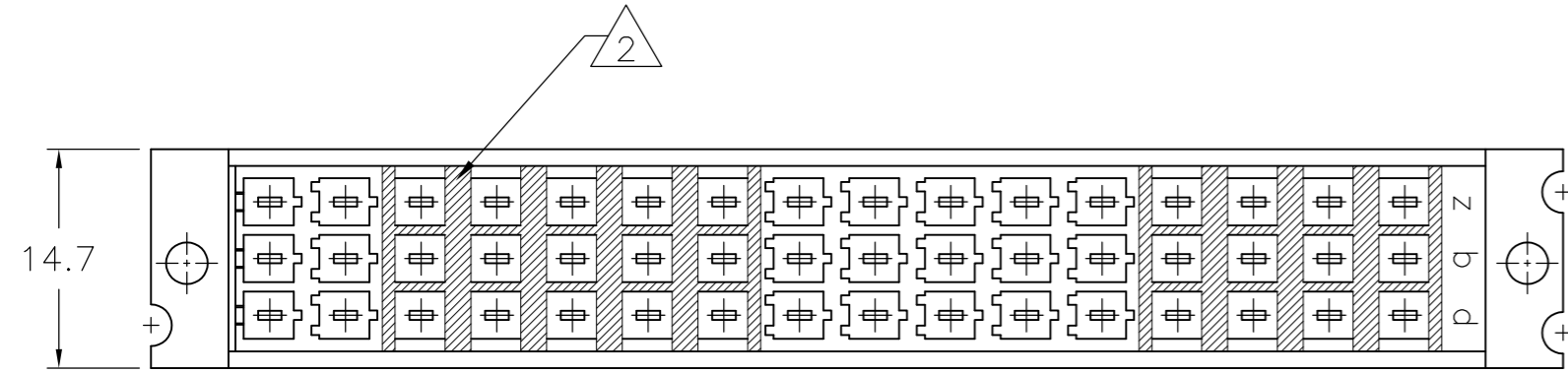
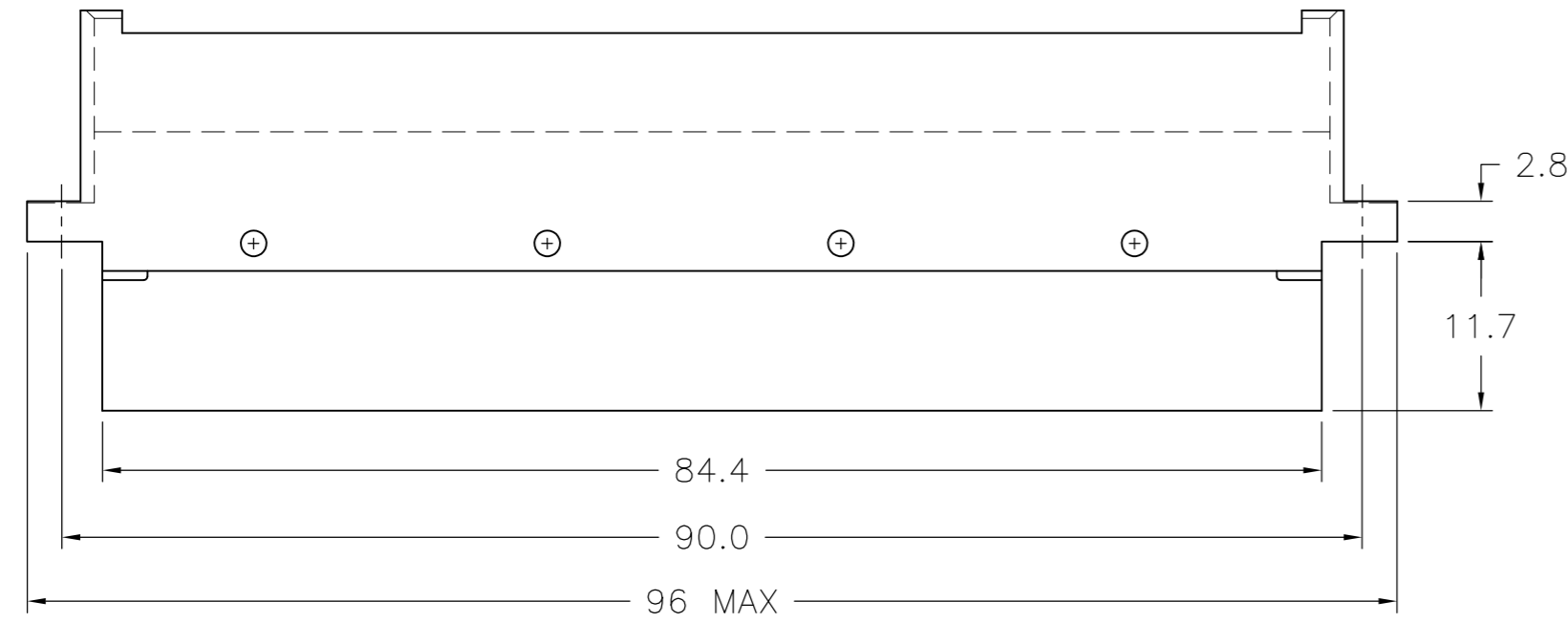

STYLE 3 FURTHER EQUAL TO 4

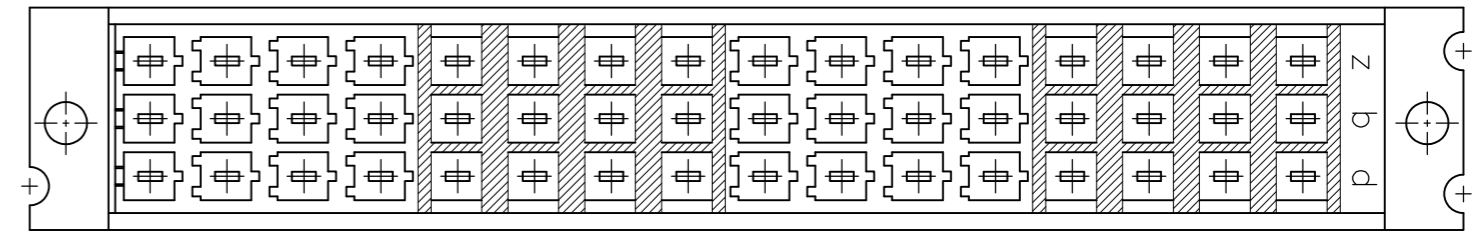

STYLE 4

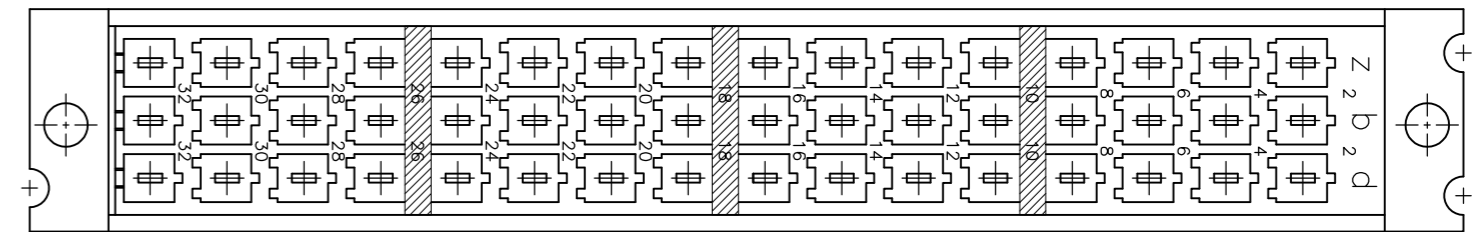

STYLE 5

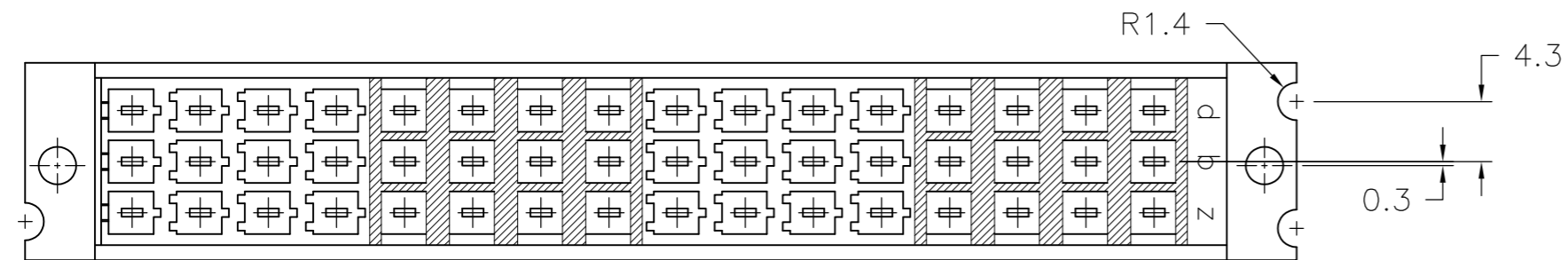

STYLE 2

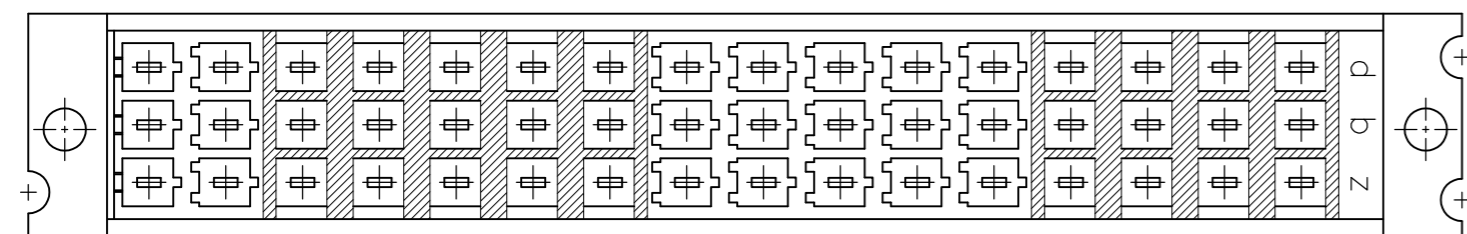

STYLE 1

	5	1-166570-0
OBSOLETE	4	166570-9
	3	166570-8
OBSOLETE	1	166570-7
	2	166570-1
	STYLE	PART NUMBER

THIS DRAWING IS A CONTROLLED DOCUMENT.		DWN	16JAN2013	TE TE Connectivity	
DIMENSIONS: mm		B.CARBO	16JAN2013		
TOLERANCES UNLESS OTHERWISE SPECIFIED:		CHK	16JAN2013	NAME 48 POS, MALE CONN ASSY, FOR COSI CONTACTS, ACC. DIN 41612	
0 PLC ± -		R.PATTERSON	16JAN2013		
1 PLC ± -		APVD	16JAN2013	SIZE A2	
2 PLC ± .02		R.PATTERSON	16JAN2013		
3 PLC ± .005		PRODUCT SPEC		CAGE CODE 00779	
4 PLC ± .0005		APPLICATION SPEC			
ANGLES ± -		WEIGHT	-	DRAWING NO C=166570	
FINISH					
MATERIAL 1		CUSTOMER DRAWING		RESTRICTED TO	
		SCALE	2:1	SHEET 1 OF 1	
		REV	E		