

### Item description

- Protected against mismatching and maintenance-free
- Push-in CAGE CLAMP® spring pressure connection technology allows solid conductors to be simply pushed into a unit.
- Low profile with 4.4 mm pole spacing
- Components can be clearly printed on and color-coded to meet custom requirements.
- When assembled, the installation connectors comply with IP40 and are suitable for easily accessible areas.

### Data

#### Electrical data

Note on contact resistance

approx. 1 mΩ of contact resistance approx. 0.25 mΩ contact transition plug/socket

#### Ratings per IEC/EN

Ratings per	IEC/EN 60664-1
Nominal voltage (III/3)	400 V

Subject to changes. Please also observe the further product documentation!

WAGO Kontakttechnik GmbH & Co. KG  
Hansastr. 27  
32423 Minden  
Phone: +49571 887-0 | Fax: +49571 887-169  
Email: [info.de@wago.com](mailto:info.de@wago.com) | Web: [www.wago.com](http://www.wago.com)

Do you have any questions about our products?  
We are always happy to take your call at +49 (571) 887-44222.



Rated surge voltage (III/3)	6 kV
Rated current	16 A
Note on rated current	13 A for 3-pole load 10 A for 4- and 5-pole load
Legend (ratings)	(III / 3) $\triangleq$ Overvoltage category III / Pollution degree 3

## Ratings per UL

Hinweis für den amerikanischen Markt	Application note for the U.S. market (USR): Some versions may also be used for current interruption in accordance with the UL certificate in select applications with currents below 5 A and voltages up to 600 V. For further information, please contact your local sales office.
Rated voltage UL 1977	600 V
Rated current UL 1977	12 A

## Connection data

Connection technology	Push-in CAGE CLAMP®
Actuation type	Operating tool Push-in
Nominal cross-section	1.5 mm <sup>2</sup>
Solid conductor	0.25 ... 1.5 mm <sup>2</sup> / 22 ... 16 AWG
Solid conductor; push-in termination	0.75 ... 1.5 mm <sup>2</sup> / 20 ... 16 AWG
Stranded conductor	0.25 ... 1 mm <sup>2</sup> / 22 ... 18 AWG
Fine-stranded conductor	0.25 ... 1.5 mm <sup>2</sup> / 22 ... 16 AWG
Fine-stranded conductor; with insulated ferrule	0.25 ... 0.75 mm <sup>2</sup> / 22 ... 20 AWG
Fine-stranded conductor; with uninsulated ferrule	0.25 ... 0.75 mm <sup>2</sup> / 22 ... 20 AWG
Fine-stranded conductor; with ferrule; push-in termination	0.75 mm <sup>2</sup> / 20 AWG
Strip length	9 mm / 0.35 inch
Note (strip length)	see also packaging or instructions
Pole No.	5
Total number of connection points	5
Total number of potentials	5
Conductor entry direction to mating direction	0°

## Physical data

Pin spacing	4.4 mm / 0.173 inch
Width	23.6 mm / 0.929 inch
Height	11.7 mm / 0.461 inch
Depth	34.1 mm / 1.343 inch

Subject to changes. Please also observe the further product documentation!

WAGO Kontakttechnik GmbH & Co. KG  
 Hansastr. 27  
 32423 Minden  
 Phone: +49571 887-0 | Fax: +49571 887-169  
 Email: [info.de@wago.com](mailto:info.de@wago.com) | Web: [www.wago.com](http://www.wago.com)

Do you have any questions about our products?  
 We are always happy to take your call at +49 (571) 887-44222.

## Mechanical data

Application	Measurement and regulation technology
Coding	B
Marking	N L - +
Potential marking	N L - +
Mating force of a plug-in connection	approx. 20 ... 70 N (depending on pole number)
Retention force of a plug-in connection	Locked: > 80 N
Unmating force of a plug-in connection	Unlocked: approx. 20 ... 70 N (depending on pole number)
Number of mating cycles	200, without resistive load
Protection type	IP20
Note on protection type	IP40 with strain relief housing

## Plug-in connection

Contact type (pluggable connector)	Female connector/socket
Connector (connection type)	for conductor
Mismating protection	Yes
Note on mismating protection	All WINSTA <sup>®</sup> components are 100% protected against mismating when: a.) plugging different numbers of poles b.) plugging while rotated 180 c.) plugging while laterally staggered d.) plugging one pole
Locking lever	Can be retrofitted
Locking of plug-in connection	locking lever
Hinweis zur Verriegelung	All connectors for mounted installations (snap-in versions for lighting fixtures or devices, all types of PCB and distribution connectors) are factory-equipped with locking levers to ensure plugs and sockets are securely locked. Additional locking levers are only required for flying leads (plug/socket).

## Material data

Color	pink
Insulation material	Polyamide (PA66)
Clamping spring material	Chrome nickel spring steel (CrNi)
Contact material	Copper or copper alloy (surface-treated)
Fire load	0.023 MJ
Weight	6 g

Subject to changes. Please also observe the further product documentation!

## Environmental requirements

Processing temperature	-5 ... +40 °C
Continuous operating temperature	-35 ... +85 °C
Note on continuous operating temperature	Insulating parts for temperatures ≤ 105 °C

## Commercial data

Packaging type	BOX
Country of origin	PL
GTIN	4055143500111
Customs tariff number	85366990990

## Approvals / Certificates

### Country specific Approvals

Logo	Approval	Additional Approval Text	Certificate name
	CB DEKRA Certification B.V.	EN 61984	71-112993
	CB DEKRA Certification B.V.	EN 61984	NL-64351

### Ship Approvals

Logo	Approval	Additional Approval Text	Certificate name
	LR Lloyds Register	EN 61535	08/20047 (E2)

## Counterpart



Item no.890-295/082-000  
Plug; 5-pole; 1,50 mm<sup>2</sup>; pink

[www.wago.com/890-295/082-000](http://www.wago.com/890-295/082-000)



Item no.890-795/082-000  
Snap-in plug; 5-pole; Cod. B; 1,50 mm<sup>2</sup>; pink

[www.wago.com/890-795/082-000](http://www.wago.com/890-795/082-000)





Subject to changes. Please also observe the further product documentation!

WAGO Kontakttechnik GmbH & Co. KG  
Hansastr. 27  
32423 Minden  
Phone: +49571 887-0 | Fax: +49571 887-169  
Email: [info.de@wago.com](mailto:info.de@wago.com) | Web: [www.wago.com](http://www.wago.com)

Do you have any questions about our products?  
We are always happy to take your call at +49 (571) 887-44222.

## Required accessories



### Locking lever

	<b>Item no.: 890-101</b> Locking lever; for manual operation; black	<a href="http://www.wago.com/890-101">www.wago.com/890-101</a>
	<b>Item no.: 890-111</b> Locking lever; for flying leads; for tool operation; black	<a href="http://www.wago.com/890-111">www.wago.com/890-111</a>
	<b>Item no.: 890-121</b> Locking lever; for manual operation; white	<a href="http://www.wago.com/890-121">www.wago.com/890-121</a>
	<b>Item no.: 890-131</b> Locking lever; for flying leads; for tool operation; white	<a href="http://www.wago.com/890-131">www.wago.com/890-131</a>



### tools

	<b>Item no.: 890-385</b> Operating tool; 5-way; green	<a href="http://www.wago.com/890-385">www.wago.com/890-385</a>
--	--	--

### assembling

	<b>Item no.: 890-310</b> Mounting carrier; 2- to 5-pole; for flying leads; black	<a href="http://www.wago.com/890-310">www.wago.com/890-310</a>
	<b>Item no.: 890-311</b> Mounting carrier; 2- to 5-pole; for flying leads; white	<a href="http://www.wago.com/890-311">www.wago.com/890-311</a>

### Strain relief plate

	<b>Item no.: 890-505</b> Strain relief housing; 5-pole; with locking clip; for 1 cable; 6.5 ... 10.5 mm; 45 mm; black	<a href="http://www.wago.com/890-505">www.wago.com/890-505</a>
	<b>Item no.: 890-515</b> Strain relief housing; 5-pole; with locking clip; for 1 cable; 6.5 ... 10.5 mm; 45 mm; white	<a href="http://www.wago.com/890-515">www.wago.com/890-515</a>

## Compatible products

### tools

	<b>Item no.: 210-719</b> Operating tool; Blade: 2.5 x 0.4 mm; with a partially insulated shaft	<a href="http://www.wago.com/210-719">www.wago.com/210-719</a>
--	---	--

## Downloads

### Documentation

#### Bid Text

890-285/082-000	8. 6. 2015	doc	Download
doc - Datei		25.1 kB	

890-285/082-000

Subject to changes. Please also observe the further product documentation!

X81 - Datei

19. 2. 2019

xml  
3.0 kB

[Download](#)

## CAD/CAE-Data

### CAD data

2D/3D Models 890-285/082-000

[URL](#)

[Download](#)

### CAE data

ZUKEN Portal 890-285/082-000

[URL](#)

[Download](#)

## Environmental Product Compliance

### Compliance Search

Environmental Product Compliance 890-285/082-000

[URL](#)

[Download](#)

Socket; 5-pole; Cod. B; 1,50 mm<sup>2</sup>; pink

## Installation Notes

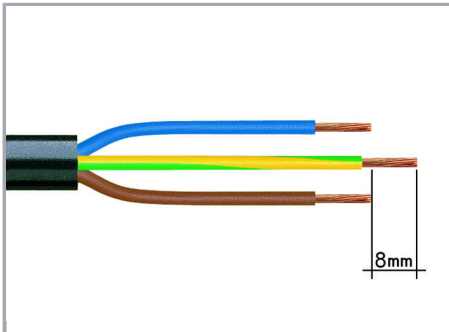

1. Strip length, outer insulation = 30 mm (2-pole), 37 mm (3-pole), 45 mm (4- and 5-pole)

2. Strip length = 9 mm

3. Extended ground conductor = 8 mm

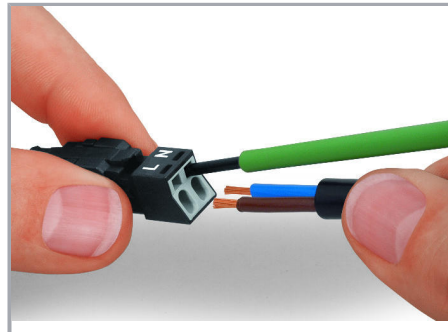

To terminate fine-stranded conductors, open the clamping unit via screwdriver – 2.5 mm blade width – and insert a stripped conductor until it hits the backstop. Terminate solid conductors by simply pushing them in.

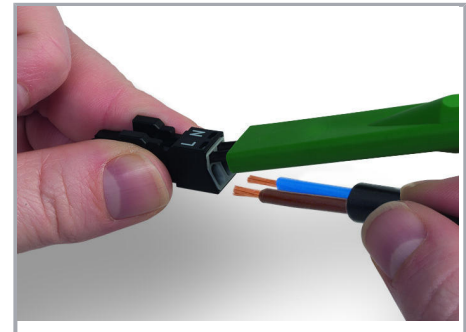

To terminate fine-stranded conductors, open clamping units via operating tool (890-382) and insert stripped conductors until they hit backstop.

Terminate solid conductors by simply pushing them in.

Subject to changes. Please also observe the further product documentation!

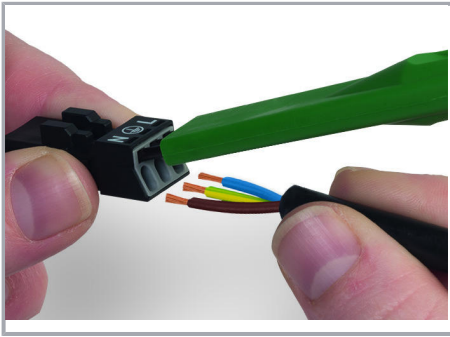

To terminate fine-stranded conductors, open clamping units via operating tool (890-383) and insert stripped conductors until they hit backstop.

Terminate solid conductors by simply pushing them in.

### Installation

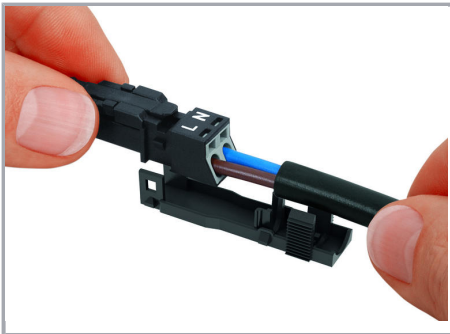

Latch the wired connector into the base of the strain relief housing.

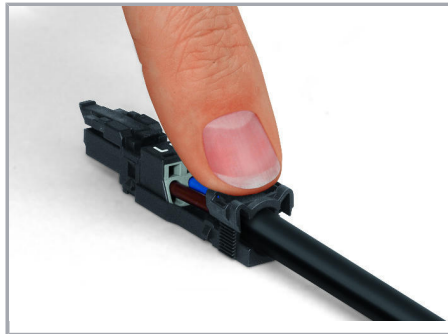

Push down strain relief clamp by hand.



Push down strain relief clamp with 2.5 mm screwdriver alternately on both sides.

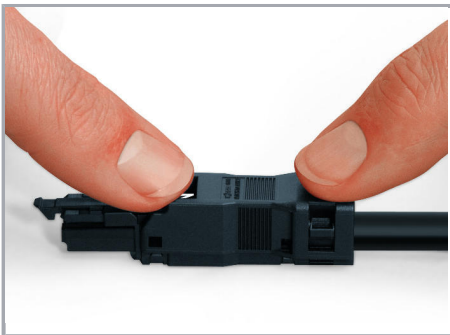

Latch the top of the strain relief housing.

Subject to changes. Please also observe the further product documentation!

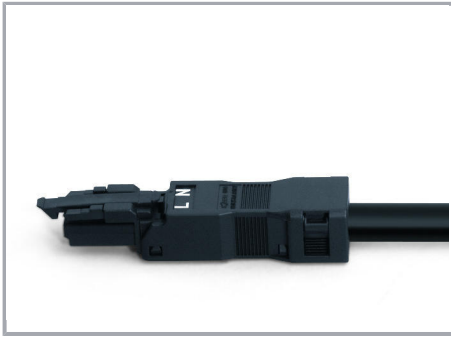

The printed marking of the connector is clearly visible in the openings of the strain relief housing.

### Mismatching protection

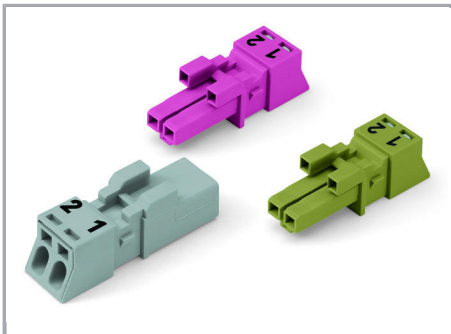

B-coded connectors with different colors can be plugged together.

#### Important note:

Different colors and/or pole markings are used for circuit identification. Only connectors of the same color and same pole marking must be plugged together.

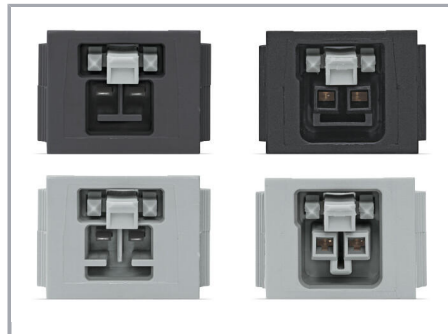

B-coded connectors (shown in gray) not only differ in color, but also in their design, making them incompatible with other coded connectors.



### Product family

<i>WINSTA</i>® MINI

[Show all products from the family](#)

Subject to changes. Please also observe the further product documentation!