

DISPLAY Elektronik GmbH

DATA SHEET

TFT MODULE

DEM 1920720D VMH-PW-N

Product Specification

Ver.: 2

20.06.2023

Table of Contents

No.	Item	Page
1.	General Description	5
2.	Module Parameter	5
3.	Absolute Maximum Ratings	6
4.	DC Characteristics	7
5.	Backlight Characteristic	7
5.1.	Backlight Characteristic	7
5.2.	Backlighting circuit	7
6.	Optical Characteristics	8
6.1.	Optical Characteristics	8
6.2.	Definition of Response Time	8
6.3.	Definition of Contrast Ratio	9
6.4.	Definition of Viewing Angles	10
6.5.	Definition of Color Appearance	10
6.6.	Definition of Surface Luminance, Uniformity and Transmittance	10
7.	Block Diagram and Power Supply	12
8.	Interface Pins Definition	13
9.	Timing Characteristics	15
9.1.	LVDS Receiver Differential Input (DC Characteristics)	15
9.2.	LVDS Receiver Differential Input (AC Characteristics)	16
9.3.	Timing Table	16
9.4.	Power sequence	17
10.	Quality Assurance	18

10.1. Purpose18

10.2. Standard for Quality Test18

10.3. Nonconforming Analysis & Disposition.....18

10.4. Agreement Items18

10.5. Standard of the Product Visual Inspection19

10.6. Inspection Specification.....19

10.7. Classification of Defects23

10.8. Identification/marketing criteria23

10.9. Packing.....23

11. Reliability Specification24

12. Precautions and Warranty25

 12.1. Safety25

 12.2. Handling25

 12.3. Storage25

 12.4. Metal Pin (Apply to Products with Metal Pins)25

 12.5. Operation.....26

 12.6. Static Electricity26

 12.7. Limited Warranty26

13. Packaging27

14. Outline Drawing28

1. General Description

The specification is a transmissive type color active matrix liquid crystal display (LCD) which uses amorphous thin film transistor (TFT) as switching devices. This product is composed of a TFT-LCD panel, driver ICs and a backlight unit.

2. Module Parameter

Features	Details	Unit
Display Size(Diagonal)	12.3"	
LCD type	IPS TFT	
Display Mode	Normally Black	
Resolution	1920 RGB x 720	Pixels
View Direction	FULL VIEWING	Best Image
Module Outline	299.432 x 119.962 x 2.90 (Note1)	mm
Active Area	292.032 x 109.512	mm
Pixel Size	0.1521 x 0.1521	mm
Pixel Arrangement	RGB Vertical stripe	
Surface treatment	AG	
Display Colors	16.7M	
Interface	LVDS interface	
With or Without Touch Panel	WithOUT	
Operating Temperature	-20~70	°C
Storage Temperature	-30~80	°C
Weight	180	g

Note 1: Exclusive hooks, posts , FFC/FPC tail etc.

3. Absolute Maximum Ratings

The followings are maximum values which, if exceed, may cause faulty operation or damage to the unit. The operational and non-operational maximum voltage and current values are listed in Table.

V_{SS}=0V, Ta=25°C

Item	Symbol	Min.	Max.	Unit
Supply Voltage	VDD	3.3	3.6	V
	AVDD	-	21	V
	VGH	-	+0.1	V
	VGL	-0.1	-	V
Storage temperature	T _{STG}	-30	+80	°C
Operating temperature	T _{OP}	-20	+70	°C

Note 1: If Ta below 50°C, the maximal humidity is 90%RH, if Ta over 50°C, absolute humidity should be less than 60%RH.

Note 2: The response time will be extremely slow when the operating temperature is around -10°C, and the back ground will become darker at high temperature operating.

Note 3: These range above is maximum value not the actual operating temperature . Actual Operating temperature is no more than 40°C and temperature refers to the LCM surface temperature ;

Note 4: GWD is not responsible for product problems beyond the use conditions.

Note 5: Temperature and relative humidity range are shown in the figure below.Wet bulb temperature should be 39 °C max. and no condensation of water.

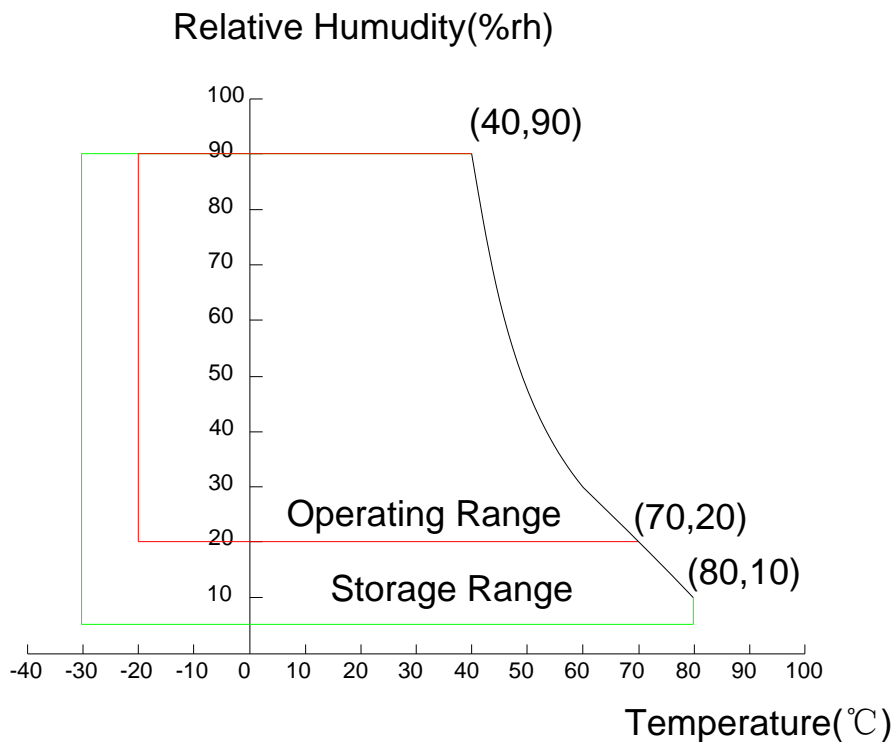

4. DC Characteristics

Item	Symbol	Min.	Typ.	Max.	Unit
Supply Voltage/current	VDD	3.0	3.3	3.6	V
	AVDD	8.0	8.2	8.4	V
	VGH	-	-	0.1	V
	VGL	-0.1	-	-	V
Logic Low input voltage	V _{IL}	0	-	0.3*VDD	V
Logic High input voltage	V _{IH}	0.7*VDD	-	VDD	V

Note 1: All of the voltage listed above are with respect to GND = 0v

Note 2: Device is subject to be damaged permanently if stresses beyond those absolute maximum rating listed above

Note 3: Typical VCOM is only a reference value. It must be optimized according to each LCM. Please use VR circuit.

5. Backlight Characteristic

5.1. Backlight Characteristic

Item	Symbol	Condition	Min	Typ	Max	Unit
Forward Voltage	V _F	Ta=25 °C, I _F =21mA/LED	-	21	-	V
Forward Current	I _F	Ta=25 °C, V _F =3V/LED	-	168	-	mA
Power dissipation	P _D		-	3528		mW
Uniformity	Avg		70	80	-	%
LED working life(25°C)	-		30000	-	-	Hrs
Drive method	Constant current					
LED Configuration	56 White LEDs(7 LEDs in one string and 8 groups in parallel)					

Note: LED life time defined as follows: The final brightness is at 50% of original brightness.

The environmental conducted under ambient air flow, at Ta=25±2 °C,60%RH±5%, I_F=20mA/LED.

5.2. Backlighting circuit

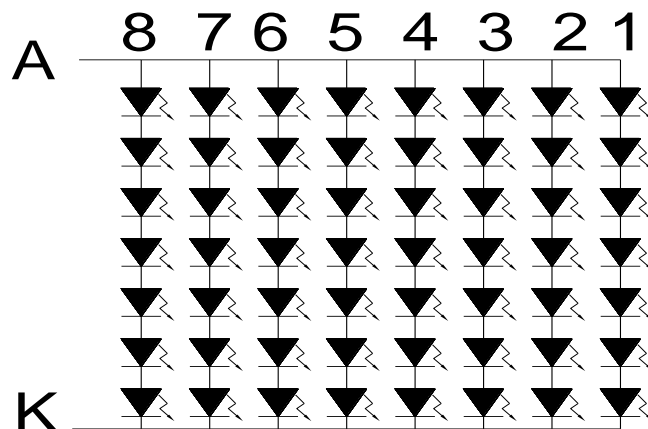

6. Optical Characteristics

6.1. Optical Characteristics

Ta=25°C, V_{DD}=3.6V

	Item	Symbol	Condition	Specification			Unit	
				Min.	Typ.	Max.		
Backlight On (Transmissive Mode)	Luminance on TFT(I _f =21mA/LED)	Lv	Normally viewing angle θ _X = φ _Y = 0°	320	400	-	cd/m ²	
	Contrast ratio	CR		900	1200	-		
	Response time	T _R +T _F		-	30	35	ms	
	Chromaticity Transmissive	Red		X _R	0.591	0.641	0.691	
				Y _R	0.292	0.342	0.392	
		Green		X _G	0.266	0.316	0.366	
				Y _G	0.569	0.619	0.669	
		Blue		X _B	0.100	0.150	0.200	
				Y _B	0.011	0.061	0.111	
		White		X _W	0.263	0.313	0.363	
				Y _W	0.279	0.329	0.379	
	Viewing Angle	Horizontal		θ _{X+}	80	89	-	Deg.
				θ _{X-}	80	89	-	
		Vertical		φ _{Y+}	80	89	-	
				φ _{Y-}	80	89	-	
NTSC Ratio(Gamut)				67	72	-	%	

6.2. Definition of Response Time

6.2.1 Normally Black Type (Negative)

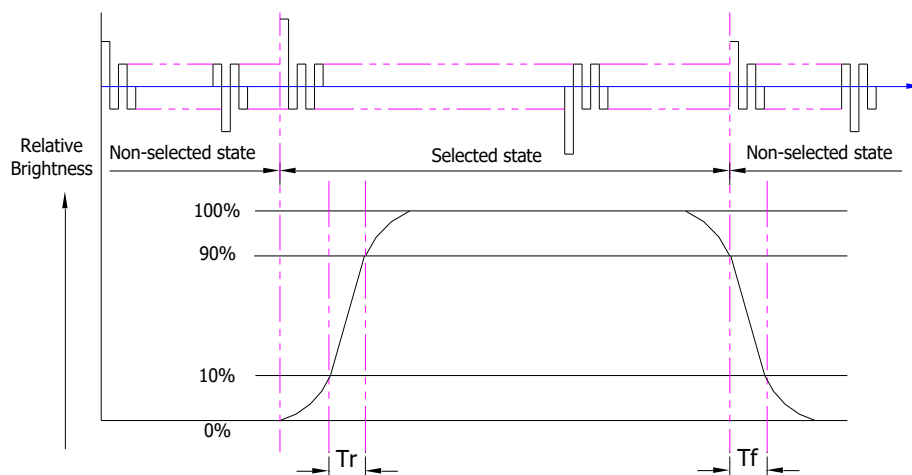

Tr is the time it takes to change form non-selected stage with relative luminance 10% to selected state with relative luminance 90%;

Tf is the time it takes to change from selected state with relative luminance 90% to non-selected state with relative luminance 10%.

Note : Measuring machine: LCD-5100

6.2.2 Normally White Type (Positive)

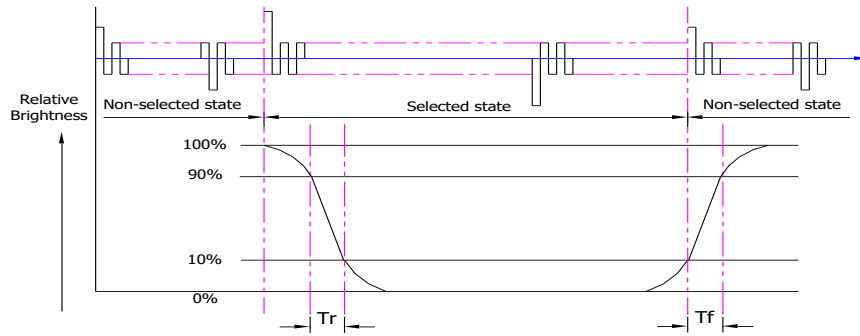

Tr is the time it takes to change form non-selected stage with relative luminance 90% to selected state with relative luminance 10%;

Tf is the time it takes to change from selected state with relative luminance 10% to non-selected state with relative luminance 90%;

Note : Measuring machine: LCD-5100 or EQUI

6.3. Definition of Contrast Ratio

Contrast is measured perpendicular to display surface in reflective and transmissive mode.

The measurement condition is:

Measuring Equipment	Eldim or Equivalent
Measuring Point Diameter	3mm//1mm
Measuring Point Location	Active Area centre point
Test pattern	A: All Pixels white
	B: All Pixel black
Contrast setting	Maximum

Definitions: CR (Contrast) = Luminance of White Pixel / Luminance of Black Pixel

6.4. Definition of Viewing Angles

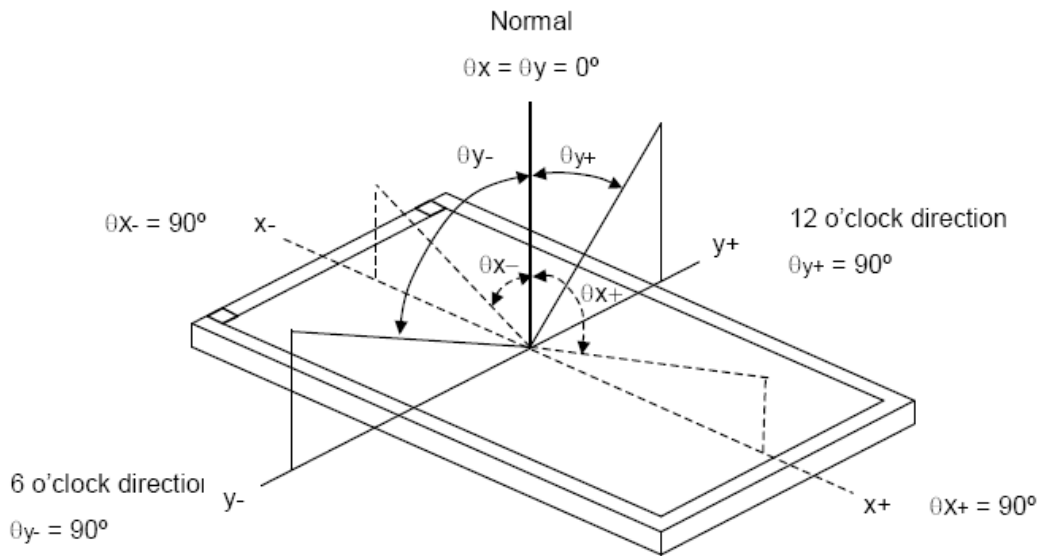

Measuring machine: LCD-5100 or EQUI

6.5. Definition of Color Appearance

R,G,B and W are defined by (x, y) on the IE chromaticity diagram

NTSC=area of RGB triangle/area of NTSC triangleX100%

Measuring picture: Red, Green, Blue and White (Measuring machine: BM-7)

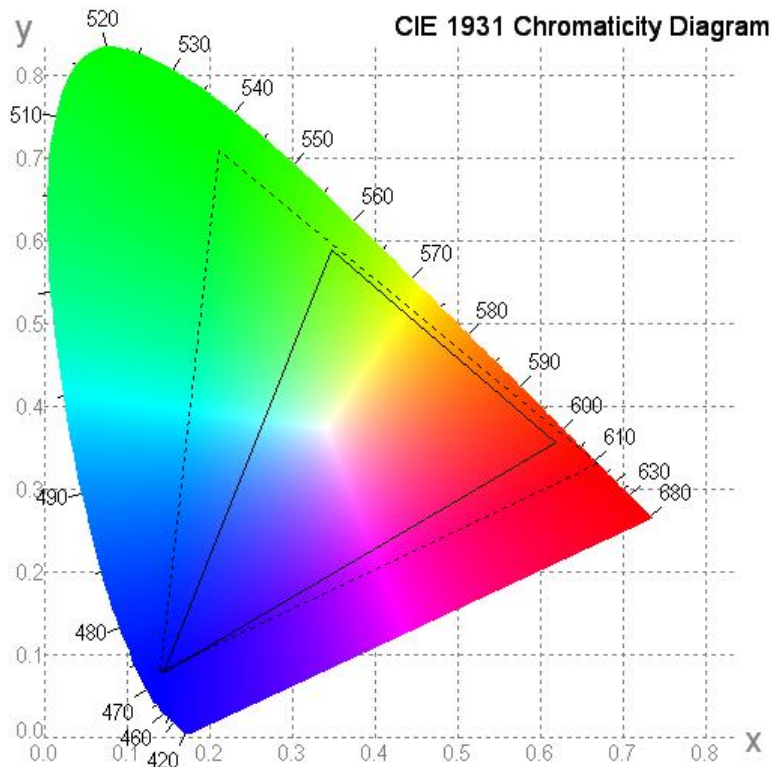

6.6. Definition of Surface Luminance, Uniformity and Transmittance

Using the transmissive mode measurement approach, measure the white screen luminance of the display panel and backlight.

- 6.6.1 Surface Luminance: $L_v = \text{average} (L_{P1}:L_{P9})$
- 6.6.2 Uniformity = $\text{Minimal} (L_{P1}:L_{P9}) / \text{Maximal} (L_{P1}:L_{P9}) * 100\%$
- 6.6.3 Transmittance = $L_v \text{ on LCD} / L_v \text{ on Backlight} * 100\%$

Note : Measuring machine: BM-7

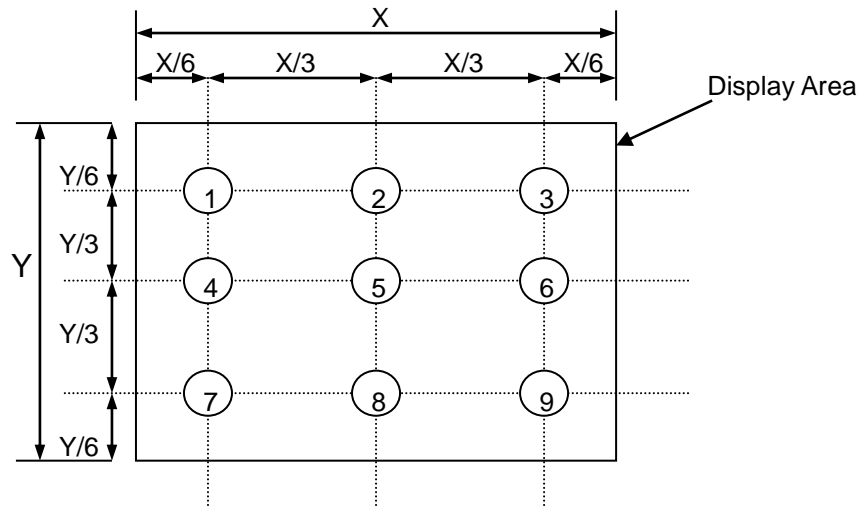

7. Block Diagram and Power Supply

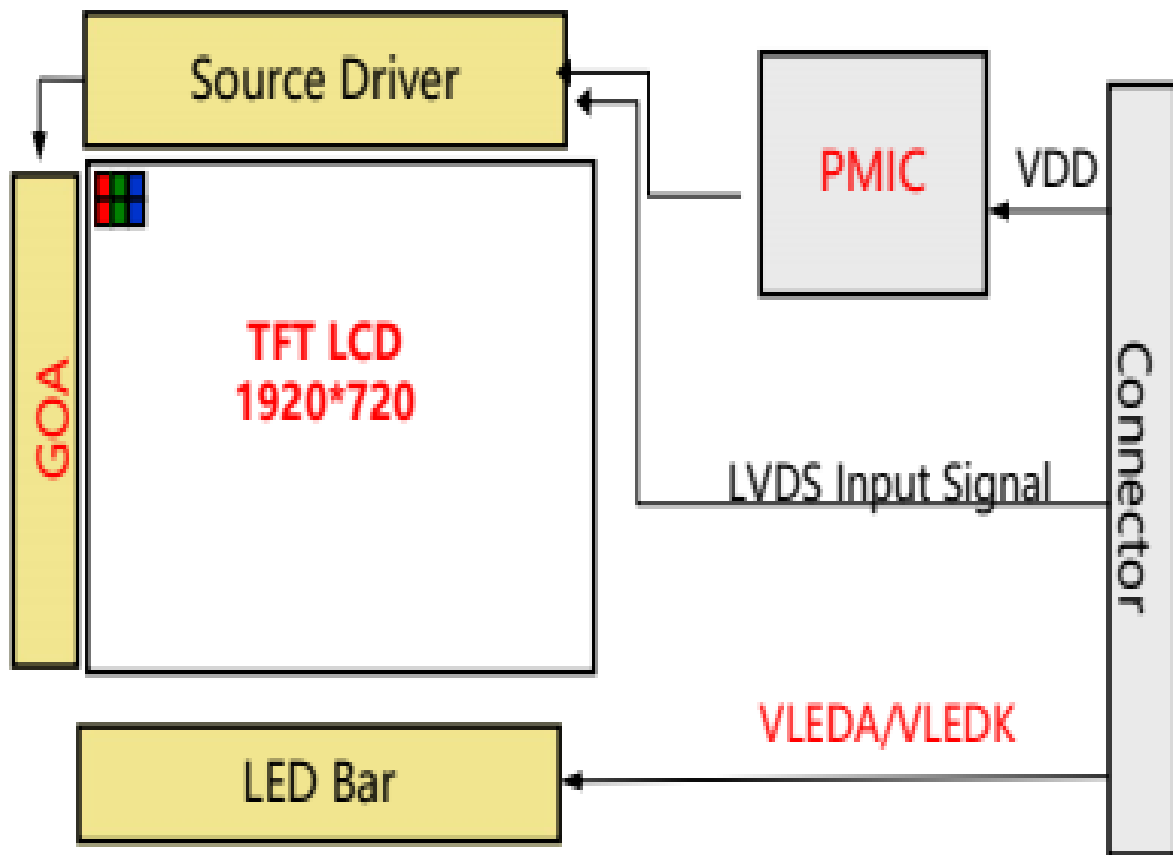

8. Interface Pins Definition

LVDS Connector:PF050-L60B-C21

No.	Symbol	Function	Remark
1	GND	GROUND	
2	NC	NC	
3	LED_A1	LED Anode1	
4	LED_A2	LED Anode2	
5	NC	NC	
6	LED_K1	LED Cathode 1	
7	LED_K2	LED Cathode 2	
8	LED_K3	LED Cathode 3	
9	LED_K4	LED Cathode 4	
10	NC(NTC1)	NC(NTC1)	
11	NC(NTC2)	NC(NTC2)	
12	NC	Reserved for BOE use only	
13	VDD	LCD Power Supply, Min. 3.0V/Typ. 3.3V/Max. 3.6V	
14	VDD	LCD Power Supply, Min. 3.0V/Typ. 3.3V/Max. 3.6V	
15	VCC_TP	Power Supply For Touch	
16	NC	NC	
17	TP_INT	Interrupt Signal for Touch	LVDS Clock
18	TP_I2C_SCL	Touch I2C CLOCK	
19	TP_I2C_SDA	Touch I2C DATA	
20	TP_RST	TP External reset single	
21	GND	GROUND	
22	STBYB	Standby mode , Default H	
23	Fail_det	Fail detect function output pin , Default H	
24	UD	UP= H(Default), U2D sequence UP= L, D2U sequence	
25	RESET	LCD reset , Default H	
26	BIST_EN	Enable BIST function, GND for Normal , Default L	
27	LR	LR= 0, shift left LR= 1(Default), shift right	
28	DISP_I2C_SDA	Display I2C DATA	
29	DISP_I2C_SCL	Display I2C CLOCK	
30	GND	GROUND	
31	DA_N_E	Negative Transmission data of Pixel 0 (EVEN)	
32	DA_P_E	Positive Transmission data of Pixel 0 (EVEN)	
33	GND	GROUND	
34	DB_N_E	Negative Transmission data of Pixel 1 (EVEN)	
35	DB_P_E	Positive Transmission data of Pixel 1 (EVEN)	
36	GND	GROUND	
37	DC_N_E	Negative Transmission data of Pixel 2 (EVEN)	
38	DC_P_E	Positive Transmission data of Pixel 2 (EVEN)	

39	GND	GROUND	
40	DCLK_N_E	Negative Transmission Clock (EVEN)	
41	DCLK_P_E	Positive Transmission Clock (EVEN)	
42	GND	GROUND	
43	DD_N_E	Negative Transmission data of Pixel 3 (EVEN)	
44	DD_P_E	Positive Transmission data of Pixel 3 (EVEN)	
45	GND	GROUND	
46	DA_N_O	Negative Transmission data of Pixel 0 (ODD)	
47	DA_P_O	Positive Transmission data of Pixel 0 (ODD)	
48	GND	GROUND	
49	DB_N_O	Negative Transmission data of Pixel 1 (ODD)	
50	DB_P_O	Positive Transmission data of Pixel 1 (ODD)	
51	GND	GROUND	
52	DC_N_O	Negative Transmission data of Pixel 2 (ODD)	
53	DC_P_O	Positive Transmission data of Pixel 2 (ODD)	
54	GND	GROUND	
55	DCLK_N_O	Negative Transmission Clock (ODD)	
56	DCLK_P_O	Positive Transmission Clock (ODD)	
57	GND	GROUND	
58	DD_N_O	Negative Transmission data of Pixel 3 (ODD)	
59	DD_P_O	Positive Transmission data of Pixel 3 (ODD)	
60	GND	GROUND	

9. Timing Characteristics

9.1. LVDS Receiver Differential Input (DC Characteristics)

Parameter	Symbol	Min	Typ	Max	Unit	Notes
Differential Input High Threshold Voltage	VTH	-	-	+100	mV	VCM=1.2V
Differential Input Low Threshold Voltage	VTL	-100	-	-	mV	
Differential Input Common Mode Voltage	VCM	0.7	1.2	1.6	V	
Differential Input Voltage	VID	100	-	600	mV	

Single-end Signals

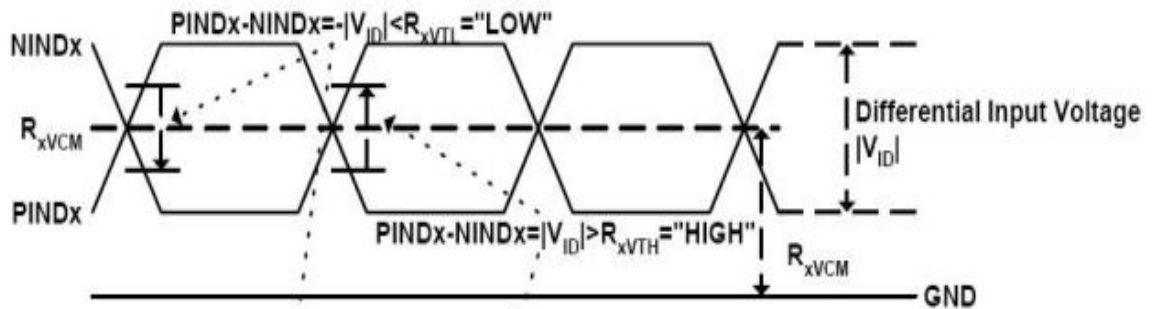

Differential Signal

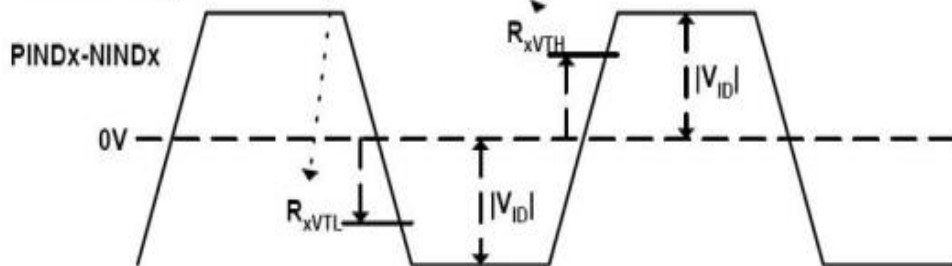

9.2. LVDS Receiver Differential Input (AC Characteristics)

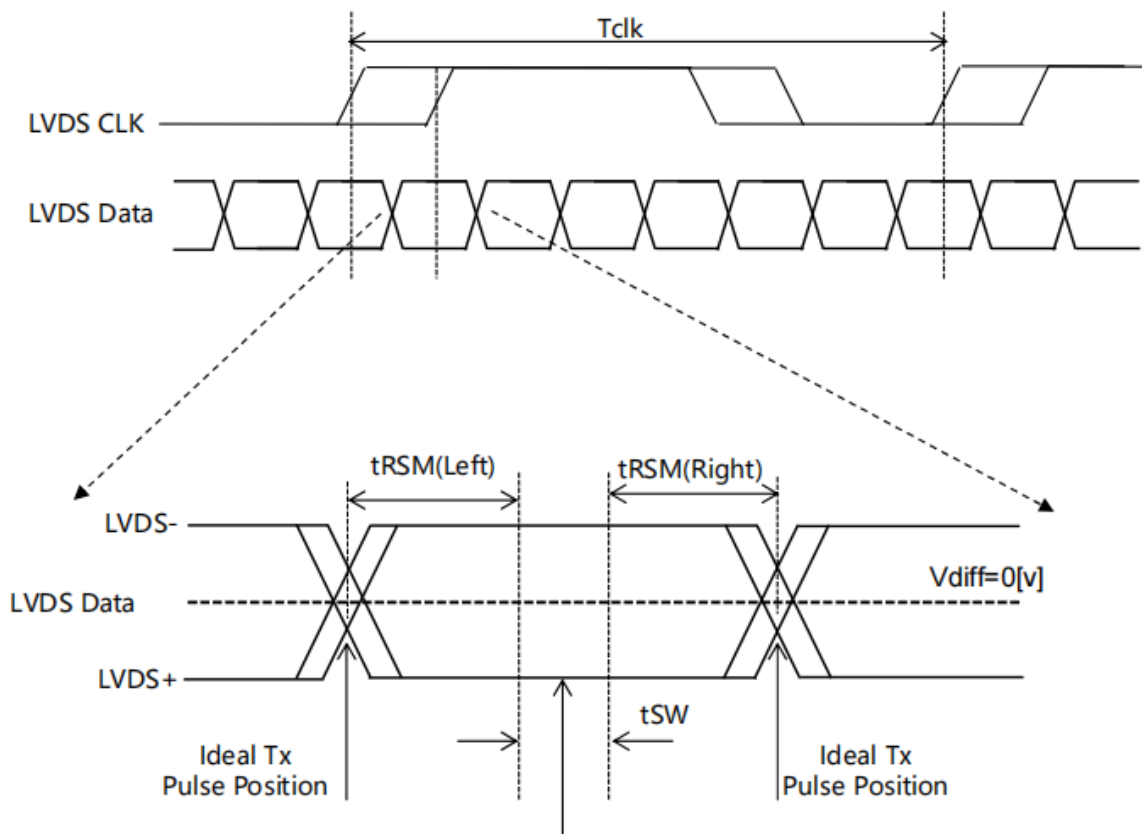

9.3. Timing Table

Item		Symbol	min	typ	max	UNIT	
LCD	Frame Rate	-	60			Hz	
	Pixels Rate	-	44.8	46.06	49.8	MHz	
Timing	Horizontal	Total time	t_{HP}	740	760	786	t_{CLK}
		Active time	t_{Hadr}	720			t_{CLK}
		Blanking time	$t_{HBP} + t_{HFP} + t_{Hsync}$	20	40	66	t_{CLK}
	Vertical	Total time	t_{VP}	1008	1010	1056	t_H
		Active time	t_{Vadr}	960			t_H
		Blanking time	$t_{VBP} + t_{VFP} + t_{Vsync}$	48	50	96	t_H
Port			-	2	-	Port	

9.4. Power sequence

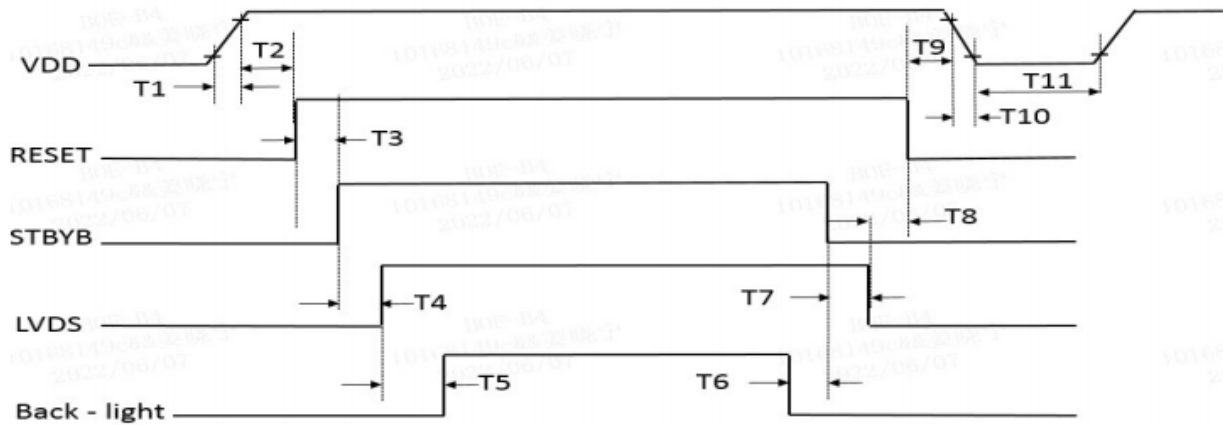

Parameter	Values			Units
	Min	Typ	Max	
T1	0.5	-	10	ms
T2	20	-	-	ms
T3	1	-	-	ms
T4	0	-	50	ms
T5	200	-	-	ms
T6	200	-	-	ms
T7	0	-	50	ms
T8	100	-	-	ms
T9	0	-	-	ms
T10	0.5	-	10	ms
T11	1000	-	-	ms

10. Quality Assurance

10.1.Purpose

This standard for Quality Assurance assures the quality of LCD module products supplied to customer.

10.2.Standard for Quality Test

10.2.1. Sampling Plan:

GB2828.1-2012

Single sampling, general inspection level II

10.2.2. Sampling Criteria:

Visual inspection: AQL 1.5

Electrical functional: AQL 0.65.

10.2.3. Reliability Test:

Detailed requirement refer to Reliability Test Specification.

10.3.Nonconforming Analysis & Disposition

10.3.1. Nonconforming analysis:

10.3.1.1. Customer should provide overall information of non-conforming sample for their complaints.

10.3.1.2. After receipt of detailed information from customer, the analysis of nonconforming parts usually should be finished in one week.

10.3.1.3. If can not finish the analysis on time, customer will be notified with the progress status.

10.3.2. Disposition of nonconforming:

10.3.2.1. Non-conforming product over PPM level will be replaced.

10.3.2.2. The cause of non-conformance will be analyzed. Corrective action will be discussed and implemented.

10.4.Agreement Items

Shall negotiate with customer if the following situation occurs:

10.4.1. There is any discrepancy in standard of quality assurance.

10.4.2. Additional requirement to be added in product specification.

10.4.3. Any other special problem.

10.5. Standard of the Product Visual Inspection

10.5.1. Appearance inspection:

10.5.1.1. The inspection must be under illumination about 1000 – 1500 lx, and the distance of view must be at 30cm ± 2cm.

10.5.1.2. The viewing angle should be 45° from the vertical line without reflection light or follows customer's viewing angle specifications.

10.5.1.3. Definition of area: A Zone: Active Area, B Zone: Viewing Area,

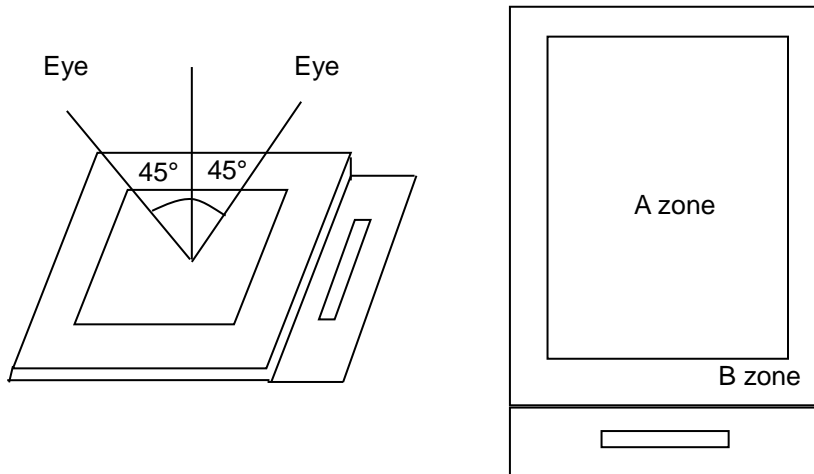

10.5.2. Basic principle:

10.5.2.1. A set of sample to indicate the limit of acceptable quality level must be discussed by both us and customer when there is any dispute happened.

10.5.2.2. New item must be added on time when it is necessary.

10.6. Inspection Specification

These inspection standards shall be applied to LCD Module supplied by INNOLUX Optoelectronics Corporation. This model is only used in CE product, if it is used in other product applications; it still adopts this copy of specification. If there are any other product applications such as handwriting recognition, Industrial use, Medical use, Aerospace usage and so on, the specifications should be negotiated separately.

01 Definition of dot defect induced from the panel inside

- a) Bright dot : Dots appear bright and unchanged in size in which LCD panel is displaying under black pattern.
- b) Dark dot : Dots appear dark and unchanged in size in which LCD panel is displaying under pure red, green, blue picture.
- c) 2 dot adjacent = 1 pair = 2 dots

Picture:

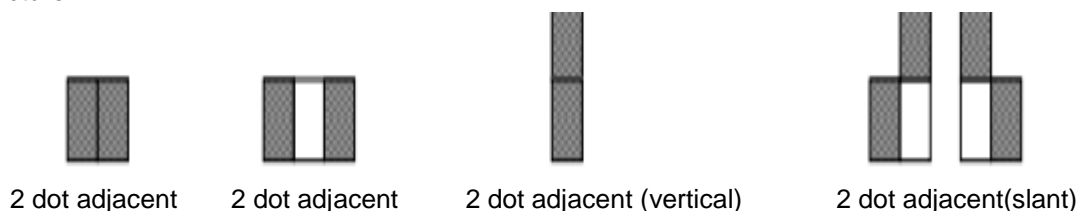

No.	Display Inspection		
02	Items		Criteria (Unit: mm)
	Bright dot	Random	$N \leq 3$
		2 dots adjacent	$N \leq 0$
		3 dots adjacent	$N \leq 0$
	Dark dot	Random	$N \leq 4$
		2 dots adjacent	$N \leq 0$
		3 dots adjacent	$N \leq 0$
	Total bright dot and dark dot		$N \leq 6$
Distance	Minimum Distance Between dark dots Minimum Distance Between dark and bright dots	5mm	
Tiny bright dot		visible through 5% ND filter $D \leq 0.3\text{mm}$, Ignore $0.3\text{mm} < D \leq 0.5\text{mm}$, $N \leq 4$ Distance $\geq 5\text{mm}$	
Display failure (V-line/Cross line etc)			
Mura/Waving/Hot spot	Not visible through 6% ND filter in 50% gray or judge by limit sample if necessary		

*Note: Defect which is on the Black Matrix (outside of Active Area) are not considered as a defect.

No.	Appearance & Display inspection		
03	Items		Criteria (Unit: mm)
	Foreign Black/White/Bright Spot (Display & Appearance)		$D \leq 0.3\text{mm}$, Ignore, $0.3\text{mm} < D \leq 0.5\text{mm}$, $N \leq 4$ Distance $\geq 5\text{mm}$, It is shown in Fig. 2.
	Foreign Black/White/Bright Line (Display & Appearance)		$W \leq 0.07\text{ mm}$, Ignore $0.07 < W \leq 0.1\text{ mm}$ $L \leq 5.0\text{ mm}$, $N \leq 4$ It is shown in Fig. 3.
	Polarizer Dent/Air Bubble		$D \leq 0.3\text{mm}$, Ignore $0.3\text{mm} < D \leq 0.5\text{mm}$, $N \leq 4$ Distance $\geq 5\text{mm}$
	Polarizer Scratches		$W \leq 0.07\text{ mm}$, Ignore $0.07 < W \leq 0.1\text{mm}$ $L \leq 5.0\text{ mm}$, $N \leq 4$

Notes: If any specific defect is not included in the above defect table, this defect should be judged by INX/ODM/Brand customer discussion.

- 1. W : Width
- 2. L : Length
- 3. D : Average Diameter
- 4. N : Count

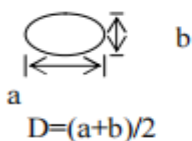
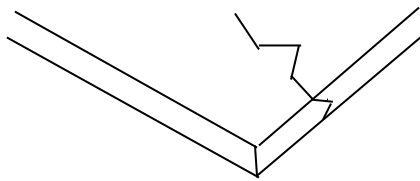
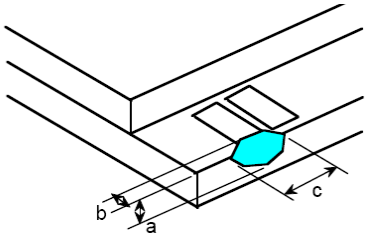
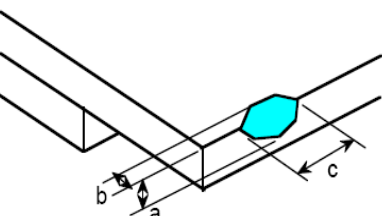
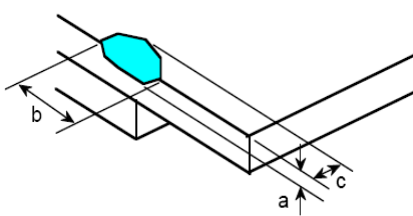
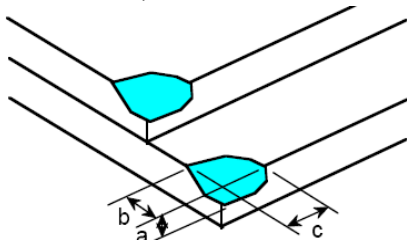

Fig. 2



W: width, L : length

Fig. 3

04	Glass Crack (Minor defect)	 <p>Crack is potential to enlarge, any type is not allowed.</p>										
05	Glass Chipping Pad Area: (Minor defect)	 <table border="1" data-bbox="858 600 1327 766"> <thead> <tr> <th>Length and Width</th> <th>Acc. Qty</th> </tr> </thead> <tbody> <tr> <td>$c > 3.0, b < 1.0$</td> <td>1</td> </tr> <tr> <td>$c < 3.0, b < 1.0$</td> <td>3</td> </tr> <tr> <td colspan="2">$a < \text{Glass Thickness}$</td> </tr> </tbody> </table>	Length and Width	Acc. Qty	$c > 3.0, b < 1.0$	1	$c < 3.0, b < 1.0$	3	$a < \text{Glass Thickness}$			
Length and Width	Acc. Qty											
$c > 3.0, b < 1.0$	1											
$c < 3.0, b < 1.0$	3											
$a < \text{Glass Thickness}$												
06	Glass Chipping Rear of Pad Area: (Minor defect)	 <table border="1" data-bbox="858 922 1327 1146"> <thead> <tr> <th>Length and Width</th> <th>Acc. Qty</th> </tr> </thead> <tbody> <tr> <td>$c > 3.0, b < 1.0$</td> <td>1</td> </tr> <tr> <td>$c < 3.0, b < 1.0$</td> <td>2</td> </tr> <tr> <td>$c < 3.0, b < 0.5$</td> <td>4</td> </tr> <tr> <td colspan="2">$a < \text{Glass Thickness}$</td> </tr> </tbody> </table>	Length and Width	Acc. Qty	$c > 3.0, b < 1.0$	1	$c < 3.0, b < 1.0$	2	$c < 3.0, b < 0.5$	4	$a < \text{Glass Thickness}$	
Length and Width	Acc. Qty											
$c > 3.0, b < 1.0$	1											
$c < 3.0, b < 1.0$	2											
$c < 3.0, b < 0.5$	4											
$a < \text{Glass Thickness}$												
07	Glass Chipping Except Pad Area: (Minor defect)	 <table border="1" data-bbox="858 1258 1327 1482"> <thead> <tr> <th>Length and Width</th> <th>Acc. Qty</th> </tr> </thead> <tbody> <tr> <td>$c > 3.0, b < 1.0$</td> <td>1</td> </tr> <tr> <td>$c < 3.0, b < 1.0$</td> <td>2</td> </tr> <tr> <td>$c < 3.0, b < 0.5$</td> <td>4</td> </tr> <tr> <td colspan="2">$a < \text{Glass Thickness}$</td> </tr> </tbody> </table>	Length and Width	Acc. Qty	$c > 3.0, b < 1.0$	1	$c < 3.0, b < 1.0$	2	$c < 3.0, b < 0.5$	4	$a < \text{Glass Thickness}$	
Length and Width	Acc. Qty											
$c > 3.0, b < 1.0$	1											
$c < 3.0, b < 1.0$	2											
$c < 3.0, b < 0.5$	4											
$a < \text{Glass Thickness}$												
08	Glass Corner Chipping: (Minor defect)	 <table border="1" data-bbox="858 1594 1327 1729"> <thead> <tr> <th>Length and Width</th> <th>Acc. Qty</th> </tr> </thead> <tbody> <tr> <td>$c < 3.0, b < 3.0$</td> <td>Ignore</td> </tr> <tr> <td colspan="2">$a < \text{Glass Thickness}$</td> </tr> </tbody> </table>	Length and Width	Acc. Qty	$c < 3.0, b < 3.0$	Ignore	$a < \text{Glass Thickness}$					
Length and Width	Acc. Qty											
$c < 3.0, b < 3.0$	Ignore											
$a < \text{Glass Thickness}$												

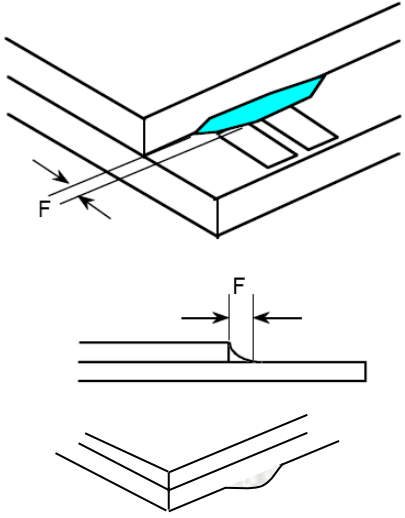
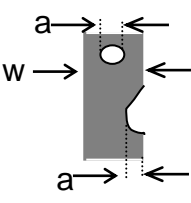
<p>09</p>	<p>Glass Burr: (Minor defect)</p> 	<table border="1" data-bbox="861 264 1332 353"> <thead> <tr> <th>Length</th> <th>Acc. Qty</th> </tr> </thead> <tbody> <tr> <td>$F < 1.0$</td> <td>Ignore</td> </tr> </tbody> </table> <p>Glass burr don't affect assemble and module dimension.</p>	Length	Acc. Qty	$F < 1.0$	Ignore				
Length	Acc. Qty									
$F < 1.0$	Ignore									
<p>10</p>	<p>FPC Defect: (Minor defect)</p> 	<p>10.1 Dent, pinhole width $a < w/3$. (w: circuitry width.) 10.2 Open circuit is unacceptable. 10.3 No oxidation, contamination and distortion.</p>								
<p>11</p>	<p>Bubble on Polarizer (Minor defect)</p>	<table border="1" data-bbox="734 1254 1204 1433"> <thead> <tr> <th>Diameter</th> <th>Acc. Qty</th> </tr> </thead> <tbody> <tr> <td>$\varphi \leq 0.30$</td> <td>Ignore</td> </tr> <tr> <td>$0.30 < \varphi \leq 0.50$</td> <td>$N \leq 2$</td> </tr> <tr> <td>$0.50 < \varphi$</td> <td>$N = 0$</td> </tr> </tbody> </table>	Diameter	Acc. Qty	$\varphi \leq 0.30$	Ignore	$0.30 < \varphi \leq 0.50$	$N \leq 2$	$0.50 < \varphi$	$N = 0$
Diameter	Acc. Qty									
$\varphi \leq 0.30$	Ignore									
$0.30 < \varphi \leq 0.50$	$N \leq 2$									
$0.50 < \varphi$	$N = 0$									
<p>12</p>	<p>Dent on Polarizer (Minor defect)</p>	<table border="1" data-bbox="734 1500 1204 1680"> <thead> <tr> <th>Diameter</th> <th>Acc. Qty</th> </tr> </thead> <tbody> <tr> <td>$\varphi \leq 0.25$</td> <td>Ignore</td> </tr> <tr> <td>$0.25 < \varphi \leq 0.50$</td> <td>$N \leq 4$</td> </tr> <tr> <td>$0.50 < \varphi$</td> <td>None</td> </tr> </tbody> </table>	Diameter	Acc. Qty	$\varphi \leq 0.25$	Ignore	$0.25 < \varphi \leq 0.50$	$N \leq 4$	$0.50 < \varphi$	None
Diameter	Acc. Qty									
$\varphi \leq 0.25$	Ignore									
$0.25 < \varphi \leq 0.50$	$N \leq 4$									
$0.50 < \varphi$	None									
<p>13</p>	<p>Bezel</p>	<p>13.1 No rust, distortion on the Bezel. 13.2 No visible fingerprints, stains or other contamination.</p>								
<p>14</p>	<p>PCB</p>	<p>14.1 No distortion or contamination on PCB terminals. 14.2 All components on PCB must same as documented on the BOM/component layout. 14.3 Follow IPC-A-600F.</p>								

15	Soldering	Follow IPC-A-610C standard
16	Electrical Defect (Major defect)	The below defects must be rejected. 16.1 Missing vertical / horizontal segment, 16.2 Abnormal Display. 16.3 No function or no display. 16.4 Current exceeds product specifications. 16.5 LCD viewing angle defect. 16.6 No Backlight. 16.7 Dark Backlight. 16.8 Touch Panel no function.

Remark: LCD Panel Broken shall be rejected. Defect out of LCD viewing area is acceptable.

10.7. Classification of Defects

- 10.7.1. Visual defects (Except no / wrong label) are treated as minor defect and electrical defect is major.
- 10.7.2. Two minor defects are equal to one major in lot sampling inspection.

10.8. Identification/marketing criteria

Any unit with illegible / wrong /double or no marking/ label shall be rejected.

10.9. Packing

- 10.9.1. There should be no damage of the outside carton box, each packaging box should have one identical label.
- 10.9.2. Modules inside package box should have compliant mark.
- 10.9.3. All direct package materials shall offer ESD protection.

Note1: Bright dot is defined as the defective area of the dot is larger than 50% of one sub-pixel area.

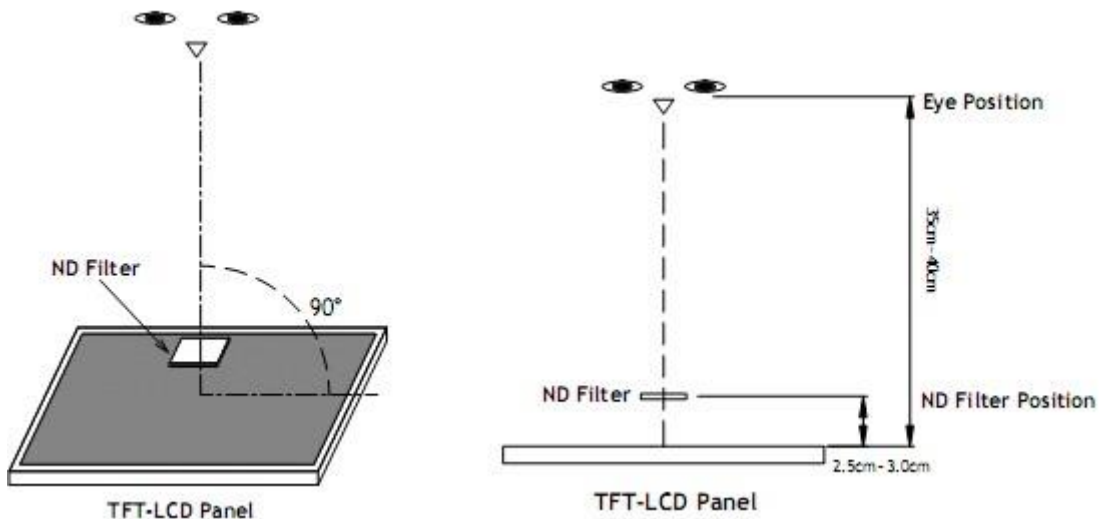

Bright dot: The bright dot size defect at black display pattern. It can be recognized by 2% transparency of filter when the distance between eyes and panel is 350mm ± 50mm.

Dark dot: Cyan, Magenta or Yellow dot size defect at white display pattern. It can be recognized by 5%

transparency of filter when the distance between eyes and panel is 350mm ±50mm.

Note2: Mura on display which appears darker / brighter against background brightness on parts of display area.

11. Reliability Specification

No	Item	Condition	Quantity	Criteria
1	High Temperature Operating	70°C, 120Hrs	2	GB/T2423.2-2008
2	Low Temperature Operating	-20°C, 120Hrs	2	GB/T2423.1-2008
3	High Humidity Storage	60°C, 90%RH,120Hrs	2	GB/T2423.3-2016
4	High Temperature Storage	80°C, 120Hrs	2	GB/T2423.2-2008
5	Low Temperature Storage	-30°C, 120Hrs	2	GB/T2423.1-2008
6	Thermal Cycling Test Storage	-20°C , 60min~70°C, 60min, 20 cycles.	2	GB/T2423.22-2012
7	Packing vibration	Frequency range:10Hz~50Hz Acceleration of gravity:5G X,Y,Z 30 min for each direction.	2	GB/T5170.14-2009
8	Electrical Static Discharge	Air: ±4KV 150pF/330 Ω 5 times Contact: ±2KV 150pF/330 Ω 5 times	2	GB/T17626.2-2018
9	Drop Test (Packaged)	Height:80 cm,1 corner, 3 edges, 6 surfaces.	2	GB/T2423.8-1995

Note1. No deflection cosmetic and operational function allowable.

Note2. Total current Consumption should be below double of initial value

12. Precautions and Warranty

12.1. Safety

- 12.1.1. The liquid crystal in the LCD is poisonous. Do not put it in your mouth. If the liquid crystal touches your skin or clothes, wash it off immediately using soap and water.
- 12.1.2. Since the liquid crystal cells are made of glass, do not apply strong impact on them. Handle with care.

12.2. Handling

- 12.2.1. Reverse and use within ratings in order to keep performance and prevent damage.
- 12.2.2. Do not wipe the polarizer with dry cloth, as it might cause scratch. If the surface of the LCD needs to be cleaned, wipe it swiftly with cotton or other soft cloth soaked with petroleum IPA, do not use other chemicals.

12.3. Storage

- 12.3.1. Do not store the LCD module beyond the specified temperature ranges.
- 12.3.2. Strong light exposure causes degradation of polarizer and color filter

12.4. Metal Pin (Apply to Products with Metal Pins)

- 12.4.1. Pins of LCD and Backlight

- 12.4.1.1. Solder tip can touch and press on the tip of Pin LEAD during the soldering

- 12.4.1.2. Recommended Soldering Conditions

- Solder Type: Sn96.3~94-Ag3.3~4.3-Cu0.4~1.1

- Maximum Solder Temperature: 370°C

- Maximum Solder Time: 3s at the maximum temperature

- Recommended Soldering Temp: 350±20°C

- Typical Soldering Time: ≤3s

- 12.4.1.3. Solder Wetting

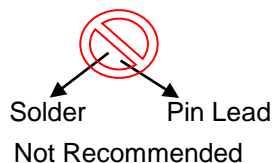
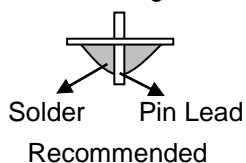

- 12.4.2. Pins of EL

- 12.4.2.1. Solder tip can touch and press on the tip of EL leads during soldering.

- 12.4.2.2. No Solder Paste on the soldering pad on the motherboard is recommended.

- 12.4.2.3. Recommended Soldering Conditions

- Solder type: Nippon Alimit Leadfree SR-34, size 0.5mm

- Recommended Solder Temperature: 270~290°C

- Typical Soldering Time: ≤2s

- Minimum solder distance from EL lamp (body):2.0mm

- 12.4.2.4. No horizontal press on the EL leads during soldering.

- 12.4.2.5. 180° bend EL leads three times is not allowed.

12.4.2.6. Solder Wetting

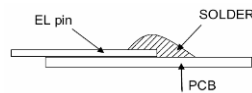

Recommended

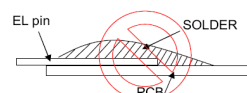

Not Recommended

12.4.2.7. The type of the solder iron:

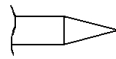

Recommended

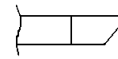

Not Recommended

12.4.2.8. Solder Pad

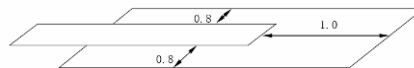

12.5. Operation

- 12.5.1. Do not drive LCD with DC voltage
- 12.5.2. Response time will increase below lower temperature
- 12.5.3. Display may change color with different temperature
- 12.5.4. Mechanical disturbance during operation, such as pressing on the display area, may cause the segments to appear “fractured”.
- 12.5.5. Do not connect or disconnect the LCM to or from the system when power is on.
- 12.5.6. Never use the LCM under abnormal condition of high temperature and high humidity.
- 12.5.7. Module has high frequency circuits. Sufficient suppression to the electromagnetic interface shall be done by system manufacturers. Grounding and shielding methods may be important to minimize the interference.
- 12.5.8. Do not display the fixed pattern for long time (we suggest the time not longer than one hour) because it may develop image sticking due to the TFT structure.

12.6. Static Electricity

- 12.6.1. CMOS LSIs are equipped in this unit, so care must be taken to avoid the electro-static charge, by ground human body, etc.
- 12.6.2. The normal static prevention measures should be observed for work clothes and benches.
- 12.6.3. The module should be kept into anti-static bags or other containers resistant to static for storage.

12.7. Limited Warranty

- 12.7.1. Our warranty liability is limited to repair and/or replacement. We will not be responsible for any consequential loss.
- 12.7.2. If possible, we suggest customer to use up all modules in six months. If the module storage time over twelve months, we suggest that recheck it before the module be used
- 12.7.3. After the product shipped, any product quality issues must be feedback within three months, otherwise, we will not be responsible for the subsequent or consequential events.

13. Packaging

- Each product is packaged in an electrostatic bag(Any connection points on the FPC must not be exposed)
- Packed in inner box with red foam tray(Do not use knife clips and other packaging methods)
- Size of Outer box:47.5*38*32.5cm
- Size of Inner box:45.5*35.5*14cm

14. Outline Drawing

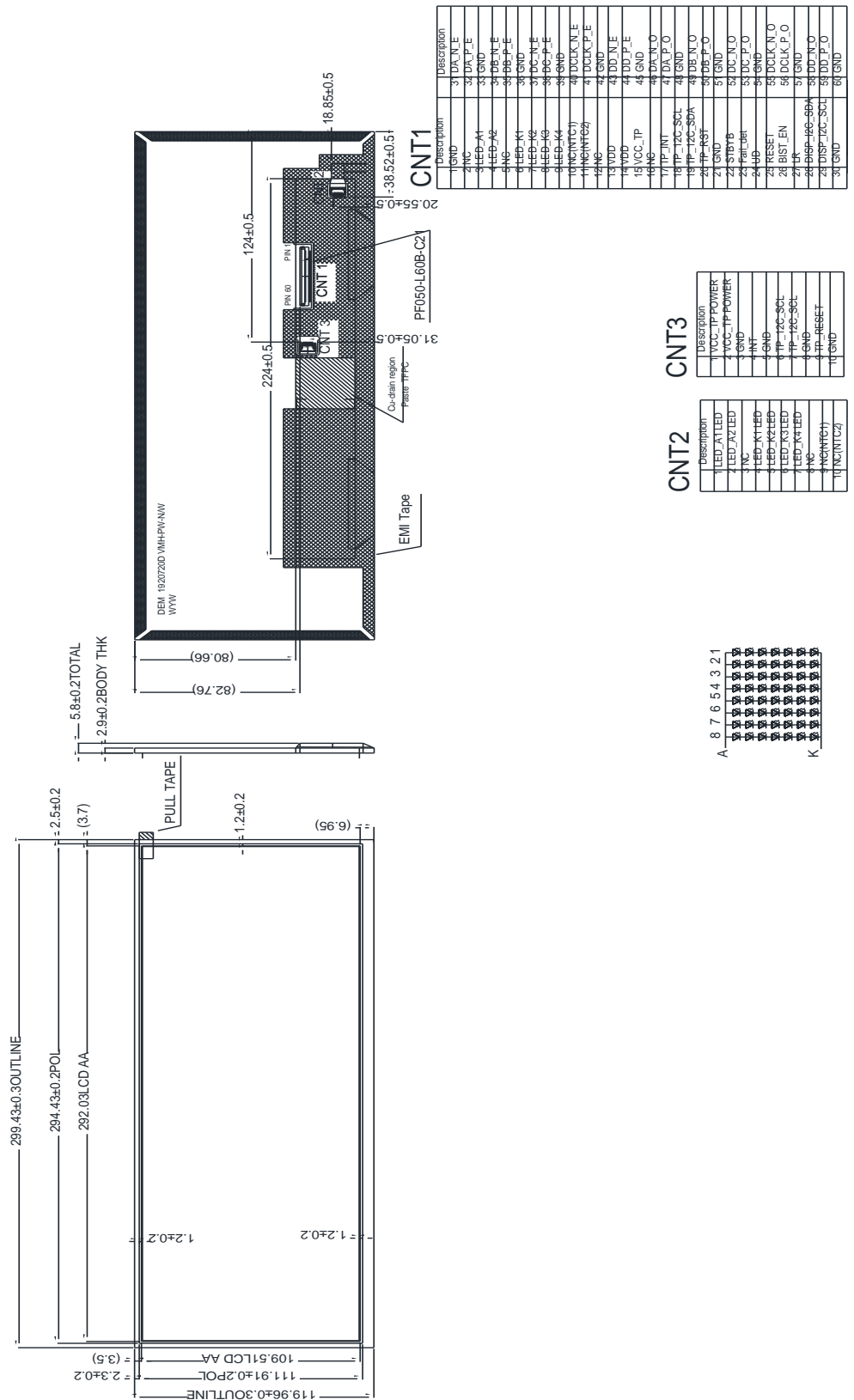

Description	Description
1 GND	31 DA_N_E
2 INC	32 DA_P_E
3 LED_A1	33 GND
4 LED_A2	34 DE_A1
5 LED_A3	35 DE_P_E
6 LED_K1	36 GND
7 LED_K2	37 DE_A1
8 LED_K3	38 DE_P_E
9 LED_K4	39 GND
10 NC	40 DE_A1
11 NC	41 DE_P_E
12 NC	42 GND
13 VDD	43 DD_N_E
14 VDD	44 DD_P_E
15 VCC_TP	45 GND
16 GND	46 DA_N_O
17 TP_INT	47 DA_P_O
18 TP_T2C_SCL	48 GND
19 TP_T2C_SDA	49 DE_N_O
20 TP_RST	50 DE_P_O
21 GND	51 GND
22 STBY_B	52 DC_N_O
23 Fail_En	53 DC_P_O
24 UB	54 GND
25 RESET	55 DCLK_N_O
26 BIST_EN	56 DCLK_P_O
27 DK	57 GND
28 DRP_L60-66A	58 DD_N_O
29 DISP_T2C_SCL	59 DD_P_O
30 GND	60 GND

CNT3

Description
1 VCC_TPPOWER
2 VCC_TPPOWER
3 GND
4 INT
5 GND
6 TP_T2C_SCL
7 TP_T2C_SCL
8 TP_RESET
9 GND
10 GND
11 GND
12 GND

CNT2

Description
1 LED_A1LED
2 LED_A2LED
3 INC
4 LED_K1LED
5 LED_K2LED
6 LED_K3LED
7 LED_K4LED
8 INC
9 NC
10 NC
11 NC
12 NC

A 8 7 6 5 4 3 2 1

1	2	3	4	5	6	7	8
9	10	11	12	13	14	15	16
17	18	19	20	21	22	23	24
25	26	27	28	29	30	31	32
33	34	35	36	37	38	39	40
41	42	43	44	45	46	47	48
49	50	51	52	53	54	55	56
57	58	59	60	61	62	63	64
65	66	67	68	69	70	71	72
73	74	75	76	77	78	79	80
81	82	83	84	85	86	87	88
89	90	91	92	93	94	95	96
97	98	99	100	101	102	103	104
105	106	107	108	109	110	111	112
113	114	115	116	117	118	119	120
121	122	123	124	125	126	127	128
129	130	131	132	133	134	135	136
137	138	139	140	141	142	143	144
145	146	147	148	149	150	151	152
153	154	155	156	157	158	159	160
161	162	163	164	165	166	167	168
169	170	171	172	173	174	175	176
177	178	179	180	181	182	183	184
185	186	187	188	189	190	191	192
193	194	195	196	197	198	199	200

K