

RoHS Compliant

[BOMcheck.net](https://www.bomcheck.net)

Color: ■

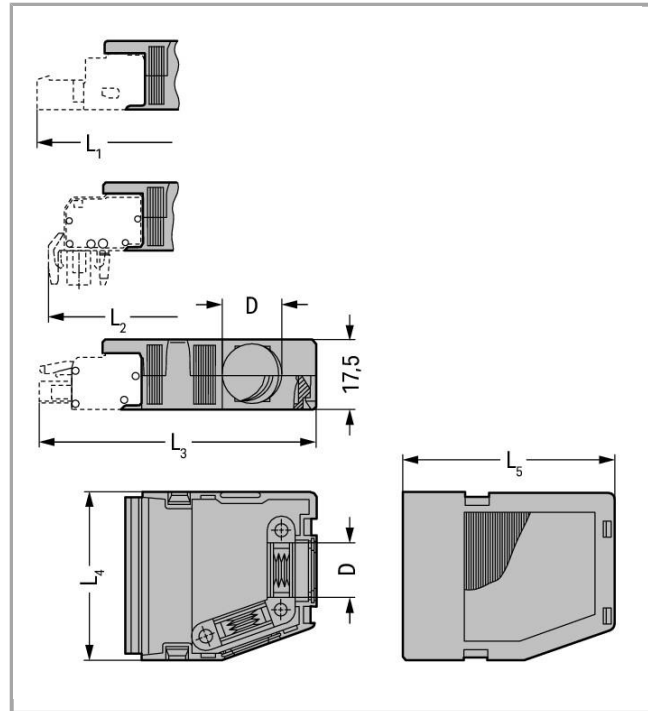

Item description

- Suitable for cable clamp
- 1 x cable outlet, rear

Data

Connection data

| | |
|----------------------------|---|
| No. of poles | 6 |
| Number of connection types | 1 |

Geometrical Data

| | |
|-------------|----------------------|
| Pin spacing | 5 mm / 0.197 inch |
| Width | 33 mm / 1.299 inch |
| Height | 17.5 mm / 0.689 inch |
| Depth | 41.5 mm / 1.634 inch |

Material Data

| | |
|-------|------|
| Color | gray |
|-------|------|



| | |
|-----------|---------|
| Fire load | 0.23 MJ |
| Weight | 7.65 g |

Commercial data

| | |
|--------------------|------------------------|
| Product Group | 3 (Multi Conn. System) |
| Country of origin | DE |
| GTIN | 4017332283052 |
| Customs Tariff No. | 85389099990 |

Approvals / Certificates



Country specific Approvals

| Logo | Approval | Additional Approval Text | Certificate name |
|------------------------------------------------------------------------------------|---------------------------------------|--------------------------|------------------|
|  | CSA DEKRA Certification B.V. | C22.2 | 1466354 |
|  | CSA DEKRA Certification B.V. | C22.2 | 1466354 |
|  | KEMA/KEUR DEKRA Certification B.V. | EN 61984 | 2190761.01 |

Ship Approvals













| Logo | Approval | Additional Approval Text | Certificate name |
|------------------------------------------------------------------------------------|------------------------------------|--------------------------|--------------------------|
|  | ABS American Bureau of Shipping | - | 14- HG1241537- PDA |

UL-Approvals

| Logo | Approval | Additional Approval Text | Certificate name |
|------------------------------------------------------------------------------------|-------------------------------------|--------------------------|------------------|
|  | UR UL International Germany GmbH | UL 1977 | E45171 |
|  | UR UL International Germany GmbH | UL 1977 | E45171 |

Compatible products

Marking accessories

| | | |
|-------------------------------------------------------------------------------------|--------------------------------------------------------------------------------------------------------------------------|----------------------------------------------------------------------------------|
|  | Item no.: 2009-115 WMB-Inline; for Smart Printer; on reel; stretchable 5 - 5.2 mm; plain; snap-on type | www.wago.com/2009-115 |
|  | Item no.: 2009-115/000-002 WMB-Inline; for Smart Printer; on reel; stretchable 5 - 5.2 mm; plain; snap-on type | www.wago.com/2009-115/000-002 |
|  | Item no.: 2009-115/000-006 WMB-Inline; for smartPRINTER; on reel; stretchable 5 - 5.2 mm; plain; snap-on type | www.wago.com/2009-115/000-006 |
|  | Item no.: 2009-115/000-007 WMB-Inline; for Smart Printer; on reel; stretchable 5 - 5.2 mm; plain; snap-on type | www.wago.com/2009-115/000-007 |
|  | Item no.: 2009-115/000-012 WMB-Inline; for smartPRINTER; on reel; stretchable 5 - 5.2 mm; plain; snap-on type | www.wago.com/2009-115/000-012 |
|  | Item no.: 2009-115/000-017 WMB-Inline; for Smart Printer; on reel; stretchable 5 - 5.2 mm; plain; snap-on type | www.wago.com/2009-115/000-017 |
|  | Item no.: 2009-115/000-023 WMB-Inline; for Smart Printer; on reel; stretchable 5 - 5.2 mm; plain; snap-on type | www.wago.com/2009-115/000-023 |
|  | Item no.: 2009-115/000-024 WMB-Inline; for smartPRINTER; on reel; stretchable 5 - 5.2 mm; plain; snap-on type | www.wago.com/2009-115/000-024 |
|  | Item no.: 793-501 WMB marking card; as card; not stretchable; plain; snap-on type | www.wago.com/793-501 |
|  | Item no.: 793-501/000-002 WMB marking card; as card; not stretchable; plain; snap-on type | www.wago.com/793-501/000-002 |
|  | Item no.: 793-501/000-005 WMB marking card; as card; not stretchable; plain; snap-on type | www.wago.com/793-501/000-005 |
|  | Item no.: 793-501/000-006 WMB marking card; as card; not stretchable; plain; snap-on type | www.wago.com/793-501/000-006 |
|  | Item no.: 793-501/000-007 WMB marking card; as card; not stretchable; plain; snap-on type | www.wago.com/793-501/000-007 |
| | Item no.: 793-501/000-012 WMB marking card; as card; not stretchable; plain; snap-on type | www.wago.com/793-501/000-012 |



Item no.: 793-501/000-017
WMB marking card; as card; not stretchable; plain; snap-on type

www.wago.com/793-501/000-017



Item no.: 793-501/000-023
WMB marking card; as card; not stretchable; plain; snap-on type

www.wago.com/793-501/000-023



Item no.: 793-501/000-024
WMB marking card; as card; not stretchable; plain; snap-on type

www.wago.com/793-501/000-024



Item no.: 793-5501
WMB marking card; as card; for terminal block width 5 - 17.5 mm; stretchable 5 - 5.2 mm; plain; snap-on type

www.wago.com/793-5501



Item no.: 793-5501/000-002
WMB marking card; as card; for terminal block width 5 - 17.5 mm; stretchable 5 - 5.2 mm; plain; snap-on type

www.wago.com/793-5501/000-002



Item no.: 793-5501/000-005
WMB marking card; as card; stretchable 5 - 5.2 mm; plain; snap-on type

www.wago.com/793-5501/000-005



Item no.: 793-5501/000-006
WMB marking card; as card; stretchable 5 - 5.2 mm; plain; snap-on type

www.wago.com/793-5501/000-006



Item no.: 793-5501/000-007
WMB marking card; as card; stretchable 5 - 5.2 mm; plain; snap-on type

www.wago.com/793-5501/000-007



Item no.: 793-5501/000-012
WMB marking card; as card; stretchable 5 - 5.2 mm; plain; snap-on type

www.wago.com/793-5501/000-012



Item no.: 793-5501/000-014
WMB marking card; as card; stretchable 5 - 5.2 mm; plain; snap-on type

www.wago.com/793-5501/000-014



Item no.: 793-5501/000-017
WMB marking card; as card; stretchable 5 - 5.2 mm; plain; snap-on type

www.wago.com/793-5501/000-017



Item no.: 793-5501/000-023
WMB marking card; as card; stretchable 5 - 5.2 mm; plain; snap-on type

www.wago.com/793-5501/000-023



Item no.: 793-5501/000-024
WMB marking card; as card; stretchable 5 - 5.2 mm; plain; snap-on type

www.wago.com/793-5501/000-024

General accessories



Item no.: 209-173
Fixing screw; for cable clamp; 7 or more poles

www.wago.com/209-173



Item no.: 209-176

Fixing screws; for cable clamp; 4- to 6-pole

www.wago.com/209-176



Item no.: 209-177

Cable clamp; for strain relief; 4- to 6-pole

www.wago.com/209-177

Downloads

Documentation

Additional Information

pdf
3.6 MB
Download

CAD/CAE - Smart Data

CAD data

3D Download 232-606

URL
Download

Subject to changes.