

Data sheet | Item number: 2206-1301

TOPJOB®S feedthrough terminal block with Push-buttons; rail mount; 3-conductor; 7.5 mm wide; gray

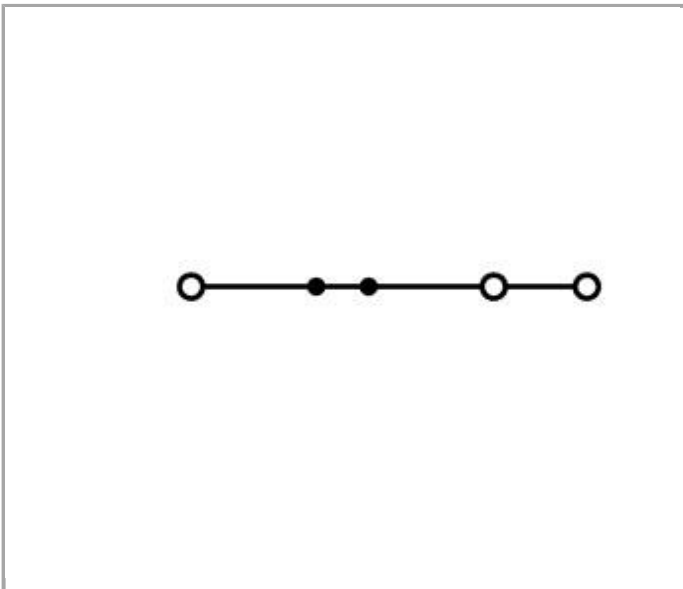

[www.wago.com/2206-1301](http://www.wago.com/2206-1301)

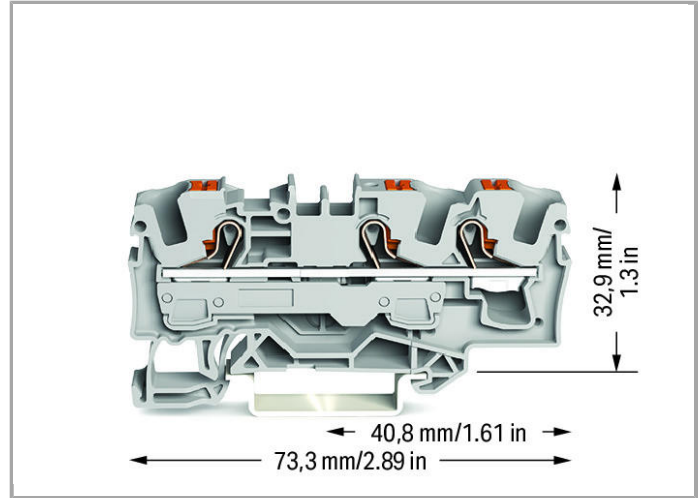
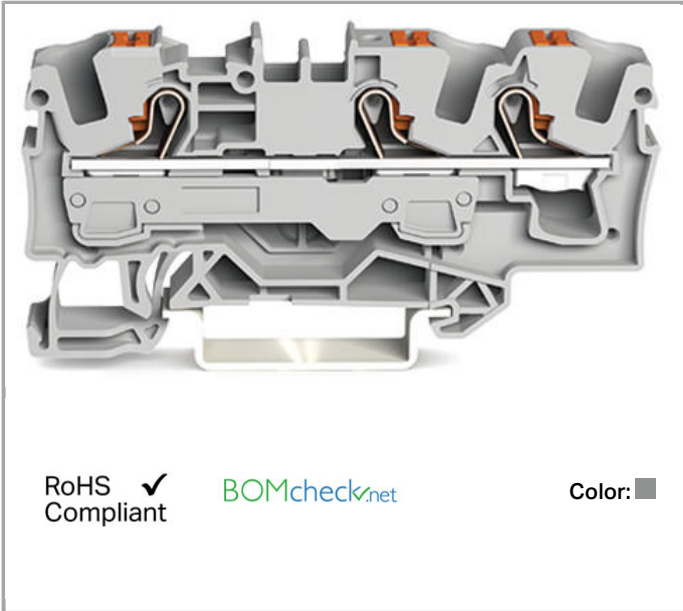

Data

Electrical data

Ratings per IEC/EN 60664-1

Rated voltage (III / 3)	800 V
Rated impulse voltage (III / 3)	8 kV
Rated current	41 A



Rated current (2)	57 A
Legend (ratings)	(III / 3) $\hat{=}$ Overvoltage category III / Pollution degree 3

### Approvals per UL 1059

Rated voltage UL (Use Group B)	600 V
Rated current UL (Use Group B)	50 A
Rated voltage UL (Use Group C)	600 V
Rated current UL (Use Group C)	50 A

### Connection data

Connection technology	Push-in CAGE CLAMP®
Actuation type	Push-in Push-button Operating tool
Connectable conductor materials	Copper
Nominal cross section	6 mm <sup>2</sup>
Solid conductor	0.5 ... 10 mm <sup>2</sup> / 20 ... 8 AWG
Solid conductor, push-in termination	1 ... 10 mm <sup>2</sup> / 14 ... 8 AWG
Fine-stranded conductor	0.5 ... 10 mm <sup>2</sup> / 20 ... 8 AWG
Fine-stranded conductor with ferrule, push-in termination, from	1.5 mm <sup>2</sup> / 16 AWG
Strip length	13 ... 15 mm / 0.51 ... 0.59 Inch
Number of levels	1
Total number of connection points	3
Total number of potentials	1
Type of wiring	Front-entry wiring

### Geometrical Data

Width	7.5 mm / 0.295 inch
Height from upper-edge of DIN-35 rail	32.9 mm / 1.295 inch
Depth	73.3 mm / 2.886 inch

### Mechanical data

Design	horizontal
Type of mounting	DIN-35 rail
Marking level	Center/side marking

### Material Data

Color	gray
Insulating material	Polyamide 66 (PA 66)
Fire load	0.01 MJ

Weight	12.934 g
--------	----------

### Commercial data



Packaging type	BOX
Country of origin	DE
GTIN	4055143712088

### Approvals / Certificates

#### Ex-Approvals

Logo	Approval	Certificate name
	<b>AEx</b> Underwriters Laboratories Inc.	4788362294

#### Country specific Approvals



Logo	Approval	Certificate name
	<b>CCA</b> DEKRA Certification B.V.	NTR NL 7667
	<b>CSA</b> DEKRA Certification B.V.	70175034
	<b>KEMA/KEUR</b> DEKRA Certification B.V.	71-102879

















#### UL-Approvals

Logo	Approval	Certificate name
	<b>UL</b> Underwriters Laboratories Inc.	478863229









### Compatible products

#### Carrier rail





	<b>Item no.: 210-112</b> Steel carrier rail; 35 x 7.5 mm; 1 mm thick; 2 m long; slotted; according to EN 60715; "Hole width 25 mm	<a href="http://www.wago.com/210-112">www.wago.com/210-112</a>
	<b>Item no.: 210-113</b> Steel carrier rail; 35 x 7.5 mm; 1 mm thick; 2 m long; unslotted; according to EN 60715	<a href="http://www.wago.com/210-113">www.wago.com/210-113</a>

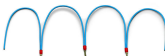















	<b>Item no.: 210-114</b> Steel carrier rail; 35 x 15 mm; 1.5 mm thick; 2 m long; unslotted; similar to EN 60715	<a href="http://www.wago.com/210-114">www.wago.com/210-114</a>
	<b>Item no.: 210-115</b> Steel carrier rail; 35 x 7.5 mm; 1 mm thick; 2 m long; slotted; according to EN 60715; "Hole width 18 mm	<a href="http://www.wago.com/210-115">www.wago.com/210-115</a>
	<b>Item no.: 210-118</b> Steel carrier rail; 35 x 15 mm; 2.3 mm thick; 2 m long; unslotted; according to EN 60715	<a href="http://www.wago.com/210-118">www.wago.com/210-118</a>
	<b>Item no.: 210-196</b> Aluminum carrier rail; 35 x 8.2 mm; 1.6 mm thick; 2 m long; unslotted; similar to EN 60715	<a href="http://www.wago.com/210-196">www.wago.com/210-196</a>
	<b>Item no.: 210-197</b> Steel carrier rail; 35 x 15 mm; 1.5 mm thick; 2 m long; slotted; similar to EN 60715	<a href="http://www.wago.com/210-197">www.wago.com/210-197</a>
	<b>Item no.: 210-198</b> Copper carrier rail; 35 x 15 mm; 2.3 mm thick; 2 m long; unslotted; according to EN 60715	<a href="http://www.wago.com/210-198">www.wago.com/210-198</a>
<b>tools</b>		
	<b>Item no.: 210-721</b> Operating tool with partially insulated shaft; Type 3, blade (5.5 x 0.8) mm	<a href="http://www.wago.com/210-721">www.wago.com/210-721</a>
<b>End plate</b>		
	<b>Item no.: 2006-1391</b> End and intermediate plate; 1 mm thick	<a href="http://www.wago.com/2006-1391">www.wago.com/2006-1391</a>
	<b>Item no.: 2006-1392</b> End and intermediate plate; 1 mm thick	<a href="http://www.wago.com/2006-1392">www.wago.com/2006-1392</a>
	<b>Item no.: 2006-1393</b> Separator plate; 2 mm thick; oversized	<a href="http://www.wago.com/2006-1393">www.wago.com/2006-1393</a>
	<b>Item no.: 2006-1394</b> Separator plate; 2 mm thick; oversized	<a href="http://www.wago.com/2006-1394">www.wago.com/2006-1394</a>
<b>check</b>		
	<b>Item no.: 2006-511</b> Modular TOPJOB®S connector; modular; for jumper contact slot; 1-pole	<a href="http://www.wago.com/2006-511">www.wago.com/2006-511</a>
	<b>Item no.: 2006-549</b> Spacer module; modular; e.g., for bridging commoned terminal blocks	<a href="http://www.wago.com/2006-549">www.wago.com/2006-549</a>
	<b>Item no.: 2009-174</b> TOPJOB®S test plug adapter; for test plug 4 mm Ø; for testing TOPJOB®S terminal blocks; gray	<a href="http://www.wago.com/2009-174">www.wago.com/2009-174</a>
	<b>Item no.: 2009-182</b> TOPJOB®S testing tap; tool-free; 12 AWG max; for testing TOPJOB®S terminal blocks; gray	<a href="http://www.wago.com/2009-182">www.wago.com/2009-182</a>
	<b>Item no.: 210-136</b> Test plug; 2 mm Ø; with 500 mm cable	<a href="http://www.wago.com/210-136">www.wago.com/210-136</a>
<b>General accessories</b>		
	<b>Item no.: 2006-191</b> Lockout cap; for wire insertion and actuating opening	<a href="http://www.wago.com/2006-191">www.wago.com/2006-191</a>

## Jumper

	<b>Item no.: 2006-402</b> Push-in type jumper bar; insulated; 2-way; Nominal current 41 A	<a href="http://www.wago.com/2006-402">www.wago.com/2006-402</a>
	<b>Item no.: 2006-403</b> Push-in type jumper bar; insulated; 3-way; Nominal current 41 A	<a href="http://www.wago.com/2006-403">www.wago.com/2006-403</a>
	<b>Item no.: 2006-404</b> Push-in type jumper bar; insulated; 4-way; Nominal current 41 A	<a href="http://www.wago.com/2006-404">www.wago.com/2006-404</a>
	<b>Item no.: 2006-405</b> Push-in type jumper bar; insulated; 5-way; Nominal current 41 A	<a href="http://www.wago.com/2006-405">www.wago.com/2006-405</a>
	<b>Item no.: 2006-405/011-000</b> Star point jumper; insulated; 3-way (1-3-5); IN = IN terminal block	<a href="http://www.wago.com/2006-405/011-000">www.wago.com/2006-405/011-000</a>
	<b>Item no.: 2006-433</b> Push-in type jumper bar; insulated; from 1 to 3; Nominal current 41 A	<a href="http://www.wago.com/2006-433">www.wago.com/2006-433</a>
	<b>Item no.: 2006-434</b> Push-in type jumper bar; insulated; from 1 to 4; Nominal current 41 A	<a href="http://www.wago.com/2006-434">www.wago.com/2006-434</a>
	<b>Item no.: 2006-435</b> Push-in type jumper bar; insulated; from 1 to 5; Nominal current 41 A	<a href="http://www.wago.com/2006-435">www.wago.com/2006-435</a>
	<b>Item no.: 2006-499</b> Step-down jumper; insulated; from 6/4 mm <sup>2</sup> to 4/2.5/1.5 mm <sup>2</sup> ; Nominal current 32 A	<a href="http://www.wago.com/2006-499">www.wago.com/2006-499</a>
	<b>Item no.: 2016-499</b> Step-down jumper; insulated; from 16/10 mm <sup>2</sup> to 10/6/4/2.5 mm <sup>2</sup> ; Nominal current 57 A	<a href="http://www.wago.com/2016-499">www.wago.com/2016-499</a>
	<b>Item no.: 210-103</b> Wire commoning chain; insulated; 50 connections	<a href="http://www.wago.com/210-103">www.wago.com/210-103</a>
	<b>Item no.: 210-123</b> Wire commoning chain; insulated; 50 connections	<a href="http://www.wago.com/210-123">www.wago.com/210-123</a>

## Marking accessories

	<b>Item no.: 2009-110</b> Marking strips; on reel; not stretchable; plain; snap-on type	<a href="http://www.wago.com/2009-110">www.wago.com/2009-110</a>
	<b>Item no.: 2009-115</b> WMB-Inline; for smartPRINTER; on reel; stretchable 5 - 5.2 mm; plain; snap-on type	<a href="http://www.wago.com/2009-115">www.wago.com/2009-115</a>
	<b>Item no.: 2009-115/000-002</b> WMB-Inline; for smartPRINTER; on reel; stretchable 5 - 5.2 mm; plain; snap-on type	<a href="http://www.wago.com/2009-115/000-002">www.wago.com/2009-115/000-002</a>
	<b>Item no.: 2009-115/000-006</b> WMB-Inline; for smartPRINTER; on reel; stretchable 5 - 5.2 mm; plain; snap-on type	<a href="http://www.wago.com/2009-115/000-006">www.wago.com/2009-115/000-006</a>
	<b>Item no.: 2009-115/000-007</b> WMB-Inline; on reel; stretchable 5 - 5.2 mm; plain; snap-on type	<a href="http://www.wago.com/2009-115/000-007">www.wago.com/2009-115/000-007</a>

	<p><b>Item no.: 2009-115/000-012</b> WMB-Inline; for smartPRINTER; on reel; stretchable 5 - 5.2 mm; plain; snap-on type</p>	<a href="http://www.wago.com/2009-115/000-012">www.wago.com/2009-115/000-012</a>
	<p><b>Item no.: 2009-115/000-017</b> WMB-Inline; on reel; stretchable 5 - 5.2 mm; plain; snap-on type</p>	<a href="http://www.wago.com/2009-115/000-017">www.wago.com/2009-115/000-017</a>
	<p><b>Item no.: 2009-115/000-023</b> WMB-Inline; for smartPRINTER; on reel; stretchable 5 - 5.2 mm; plain; snap-on type</p>	<a href="http://www.wago.com/2009-115/000-023">www.wago.com/2009-115/000-023</a>
	<p><b>Item no.: 2009-115/000-024</b> WMB-Inline; for smartPRINTER; on reel; stretchable 5 - 5.2 mm; plain; snap-on type</p>	<a href="http://www.wago.com/2009-115/000-024">www.wago.com/2009-115/000-024</a>
	<p><b>Item no.: 2009-145</b> Mini-WSB Inline; for smartPRINTER; on reel; stretchable 5 - 5.2 mm; plain; snap-on type</p>	<a href="http://www.wago.com/2009-145">www.wago.com/2009-145</a>
	<p><b>Item no.: 2009-145/000-002</b> Mini-WSB Inline; for smartPRINTER; on reel; stretchable 5 - 5.2 mm; plain; snap-on type</p>	<a href="http://www.wago.com/2009-145/000-002">www.wago.com/2009-145/000-002</a>
	<p><b>Item no.: 2009-145/000-005</b> Mini-WSB Inline; for smartPRINTER; on reel; stretchable 5 - 5.2 mm; plain; snap-on type</p>	<a href="http://www.wago.com/2009-145/000-005">www.wago.com/2009-145/000-005</a>
	<p><b>Item no.: 2009-145/000-006</b> Mini-WSB Inline; for smartPRINTER; on reel; stretchable 5 - 5.2 mm; plain; snap-on type</p>	<a href="http://www.wago.com/2009-145/000-006">www.wago.com/2009-145/000-006</a>
	<p><b>Item no.: 2009-145/000-007</b> Mini-WSB Inline; plain; 1,700 Mini-WSB markers (5 mm) on roll; stretchable 5 - 5.2 mm</p>	<a href="http://www.wago.com/2009-145/000-007">www.wago.com/2009-145/000-007</a>
	<p><b>Item no.: 2009-145/000-012</b> Mini-WSB Inline; for smartPRINTER; on reel; stretchable 5 - 5.2 mm; plain; snap-on type</p>	<a href="http://www.wago.com/2009-145/000-012">www.wago.com/2009-145/000-012</a>
	<p><b>Item no.: 2009-145/000-023</b> Mini-WSB Inline; on reel; stretchable 5 - 5.2 mm; plain; snap-on type</p>	<a href="http://www.wago.com/2009-145/000-023">www.wago.com/2009-145/000-023</a>
	<p><b>Item no.: 2009-145/000-024</b> Mini-WSB Inline; on reel; stretchable 5 - 5.2 mm; plain; snap-on type</p>	<a href="http://www.wago.com/2009-145/000-024">www.wago.com/2009-145/000-024</a>
	<p><b>Item no.: 2009-191</b> Group marker carrier</p>	<a href="http://www.wago.com/2009-191">www.wago.com/2009-191</a>
	<p><b>Item no.: 2009-192</b> Group marker carrier</p>	<a href="http://www.wago.com/2009-192">www.wago.com/2009-192</a>
	<p><b>Item no.: 2009-193</b> Group marker carrier</p>	<a href="http://www.wago.com/2009-193">www.wago.com/2009-193</a>
	<p><b>Item no.: 2009-198</b> Adaptor</p>	<a href="http://www.wago.com/2009-198">www.wago.com/2009-198</a>

**Item no.: 248-501**

Miniature WSB Quick marking system; plain; Marker width 5 mm; 10 strips with 10 markers per card

[www.wago.com/248-501](http://www.wago.com/248-501)**Item no.: 248-501/000-002**

Mini-WSB marking card; as card; not stretchable; plain; snap-on type

[www.wago.com/248-501/000-002](http://www.wago.com/248-501/000-002)**Item no.: 248-501/000-005**

Mini-WSB marking card; as card; plain; snap-on type

[www.wago.com/248-501/000-005](http://www.wago.com/248-501/000-005)**Item no.: 248-501/000-006**

Mini-WSB marking card; as card; not stretchable; plain; snap-on type

[www.wago.com/248-501/000-006](http://www.wago.com/248-501/000-006)**Item no.: 248-501/000-007**

Mini-WSB marking card; as card; not stretchable; plain; snap-on type

[www.wago.com/248-501/000-007](http://www.wago.com/248-501/000-007)**Item no.: 248-501/000-012**

Mini-WSB marking card; as card; not stretchable; plain; snap-on type

[www.wago.com/248-501/000-012](http://www.wago.com/248-501/000-012)**Item no.: 248-501/000-017**

Mini-WSB marking card; as card; not stretchable; plain; snap-on type

[www.wago.com/248-501/000-017](http://www.wago.com/248-501/000-017)**Item no.: 248-501/000-023**

Mini-WSB marking card; as card; not stretchable; plain; snap-on type

[www.wago.com/248-501/000-023](http://www.wago.com/248-501/000-023)**Item no.: 248-501/000-024**

Mini-WSB marking card; as card; not stretchable; plain; snap-on type

[www.wago.com/248-501/000-024](http://www.wago.com/248-501/000-024)**Item no.: 793-501**

WMB marking card; as card; not stretchable; plain; snap-on type

[www.wago.com/793-501](http://www.wago.com/793-501)**Item no.: 793-501/000-002**

WMB marking card; as card; not stretchable; plain; snap-on type

[www.wago.com/793-501/000-002](http://www.wago.com/793-501/000-002)**Item no.: 793-501/000-005**

WMB marking card; as card; not stretchable; plain; snap-on type

[www.wago.com/793-501/000-005](http://www.wago.com/793-501/000-005)**Item no.: 793-501/000-006**

WMB marking card; as card; not stretchable; plain; snap-on type

[www.wago.com/793-501/000-006](http://www.wago.com/793-501/000-006)**Item no.: 793-501/000-007**

WMB marking card; as card; not stretchable; plain; snap-on type

[www.wago.com/793-501/000-007](http://www.wago.com/793-501/000-007)**Item no.: 793-501/000-012**

WMB marking card; as card; not stretchable; plain; snap-on type

[www.wago.com/793-501/000-012](http://www.wago.com/793-501/000-012)



**Item no.: 793-501/000-017**  
WMB marking card; as card; not stretchable; plain; snap-on type

[www.wago.com/793-501/000-017](http://www.wago.com/793-501/000-017)



**Item no.: 793-501/000-023**  
WMB marking card; as card; not stretchable; plain; snap-on type

[www.wago.com/793-501/000-023](http://www.wago.com/793-501/000-023)



**Item no.: 793-501/000-024**  
WMB marking card; as card; not stretchable; plain; snap-on type

[www.wago.com/793-501/000-024](http://www.wago.com/793-501/000-024)



**Item no.: 793-5501**  
WMB marking card; as card; for terminal block width 5 - 17.5 mm; stretchable 5 - 5.2 mm; plain; snap-on type

[www.wago.com/793-5501](http://www.wago.com/793-5501)



**Item no.: 793-5501/000-002**  
WMB marking card; as card; for terminal block width 5 - 17.5 mm; stretchable 5 - 5.2 mm; plain; snap-on type

[www.wago.com/793-5501/000-002](http://www.wago.com/793-5501/000-002)



**Item no.: 793-5501/000-005**  
WMB marking card; as card; stretchable 5 - 5.2 mm; plain; snap-on type

[www.wago.com/793-5501/000-005](http://www.wago.com/793-5501/000-005)



**Item no.: 793-5501/000-006**  
WMB marking card; as card; stretchable 5 - 5.2 mm; plain; snap-on type

[www.wago.com/793-5501/000-006](http://www.wago.com/793-5501/000-006)



**Item no.: 793-5501/000-007**  
WMB marking card; as card; stretchable 5 - 5.2 mm; plain; snap-on type

[www.wago.com/793-5501/000-007](http://www.wago.com/793-5501/000-007)



**Item no.: 793-5501/000-012**  
WMB marking card; as card; stretchable 5 - 5.2 mm; plain; snap-on type

[www.wago.com/793-5501/000-012](http://www.wago.com/793-5501/000-012)



**Item no.: 793-5501/000-017**  
WMB marking card; as card; stretchable 5 - 5.2 mm; plain; snap-on type

[www.wago.com/793-5501/000-017](http://www.wago.com/793-5501/000-017)



**Item no.: 793-5501/000-023**  
WMB marking card; as card; stretchable 5 - 5.2 mm; plain; snap-on type

[www.wago.com/793-5501/000-023](http://www.wago.com/793-5501/000-023)



**Item no.: 793-5501/000-024**  
WMB marking card; as card; stretchable 5 - 5.2 mm; plain; snap-on type

[www.wago.com/793-5501/000-024](http://www.wago.com/793-5501/000-024)

## ferrule



**Item no.: 216-208**  
Ferrule; Sleeve for 6 mm<sup>2</sup> / AWG 10; insulated; electro-tin plated; electrolytic copper; gastight crimped; acc. to DIN 46228, Part 4/09.90

[www.wago.com/216-208](http://www.wago.com/216-208)



**Item no.: 216-262**  
Ferrule; Sleeve for 0.75 mm<sup>2</sup> / AWG 20; insulated; electro-tin plated; electrolytic copper; gastight crimped; acc. to DIN 46228, Part 4/09.90

[www.wago.com/216-262](http://www.wago.com/216-262)



**Item no.: 216-263**  
Ferrule; Sleeve for 1 mm<sup>2</sup> / AWG 18; insulated; electro-tin plated; electrolytic copper; gastight crimped; acc. to DIN 46228, Part 4/09.90

[www.wago.com/216-263](http://www.wago.com/216-263)





**Item no.: 216-264**

Ferrule; Sleeve for 1.5 mm<sup>2</sup> / AWG 16; insulated; electro-tin plated; electrolytic copper; gastight crimped; acc. to DIN 46228, Part 4/09.90

[www.wago.com/216-264](http://www.wago.com/216-264)



**Item no.: 216-266**

Ferrule; Sleeve for 2.5 mm<sup>2</sup> / AWG 14; insulated; electro-tin plated; electrolytic copper; gastight crimped; acc. to DIN 46228, Part 4/09.90

[www.wago.com/216-266](http://www.wago.com/216-266)



**Item no.: 216-267**

Ferrule; Sleeve for 4 mm<sup>2</sup> / AWG 12; insulated; electro-tin plated; electrolytic copper; gastight crimped; acc. to DIN 46228, Part 4/09.90

[www.wago.com/216-267](http://www.wago.com/216-267)

**Downloads**

**Documentation**

**Bid Text**

2206-1301	15.8.2018	DOCX 15.2 kB	Download
-----------	-----------	-----------------	----------

**CAD files**

**CAD data**

3D Download 2206-1301	Download
-----------------------	----------

Subject to changes.

WAGO Corporation  
Germantown, WI 53022  
32423 Minden  
Phone: +49571 887-0 | Fax: (262) 255-6222  
Email: [info.us@wago.com](mailto:info.us@wago.com) | Web: [www.wago.com](http://www.wago.com)

Do you have any questions about our products?  
We are always happy to take your call at {0}.