

REV.	DESCRIPTION	DRAWN	DATE
1	INITIAL RELEASE	FROS	2025/08/13

SPECIFICATION:

1. ELECTRICAL

- 1.1 Current Rating: 1.5A per pin
- 1.2 Voltage Rating: AC 335Vrms
- 1.3 Contact Resistance: 10mΩ
- 1.4 Insulation Resistance: 100MΩ
- 1.5 Dielectric Withstanding Voltage: 500VAC
- 1.6 Impedance: 100Ω
- 1.7 Frequency: 10 GHz

2. MECHANICAL

- 2.1 Durability: 25 Cycle

3. ENVIRONMENTAL

- 3.1 Operating temperature range: -40°C~+105°C
- 3.2 Storage temperature range: -40°C~+105°C

4. SOLDER ABILITY

- 4.1 Recommended Wave Soldering Temperature: 260°C

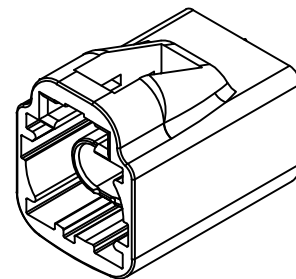
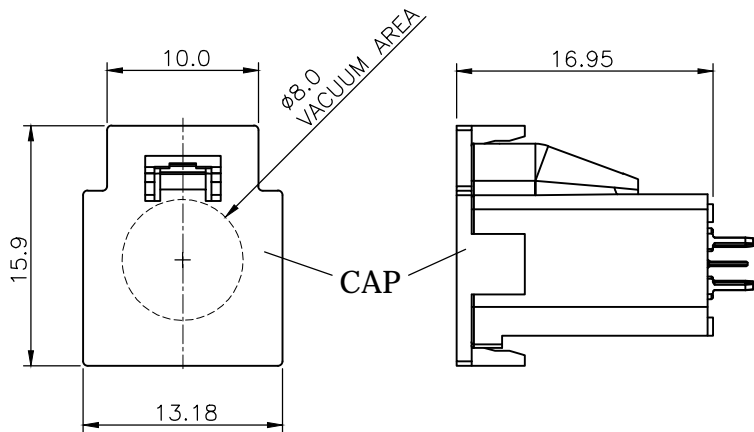
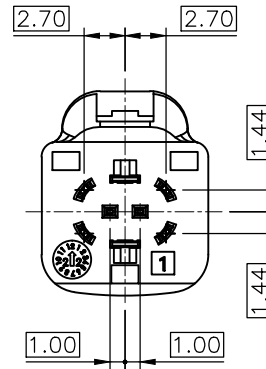
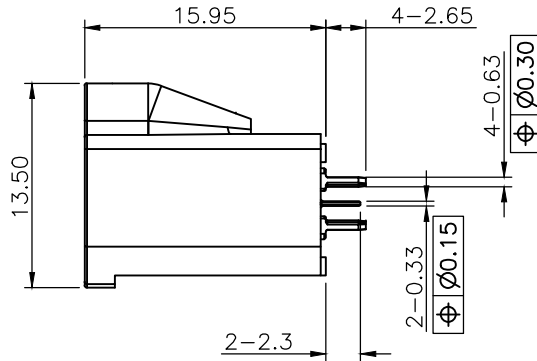
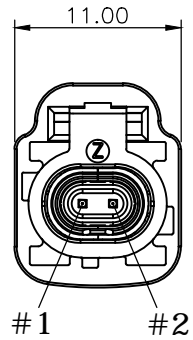

3	SHELL	Copper alloy, matte tin plating over nickel	
2	CONTACT	Copper alloy, 6u" gold plating on contact area, tin plating on solder tails, under plating nickel over all	
1	HOUSING	PA	
NO.	PART NAME	DESCRIPTION	
UNLESS OTHERWISE SPECIFIED TOLERANCE			
UNIT:	DECIMAL	LINEAR	ANGLES
	mm	X. ±0.50	±5°
		X.X ±0.25	±3°
	X.XX ±0.12	±1°	
DRAWN		Fros	2025/08/13
CHECKED		Tim	2025/08/13
APPROVED		Ken	2025/08/13
SCALE		SHEET	SIZE
2/1		1/3	A4
DRAWN NAME:		HS-MTP Plug, Straight	
PRODUCT NO.		232A-PSX00	
FILE NAME		232A-PSX00_B_1	





www.attend.com.tw

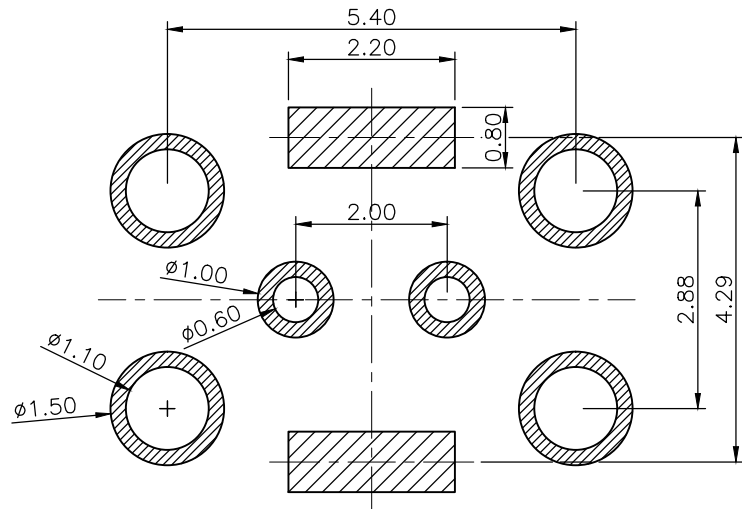









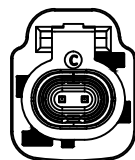

REV.	DESCRIPTION	DRAWN	DATE



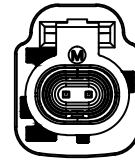

Recommended Layout (top view)
General Tolerance: $\pm 0.05\text{mm}$

UNLESS OTHERWISE SPECIFIED TOLERANCE				 www.attend.com.tw	
UNIT:	DECIMAL	LINEAR	ANGLES		
mm	X.	± 0.50	$\pm 5^\circ$		
	X.X	± 0.25	$\pm 3^\circ$		
	X.XX	± 0.12	$\pm 1^\circ$		
DRAWN	Fros	2025/08/13	DRAWN NAME:		
CHECKED	Tim	2025/08/13	HS-MTP Plug, Straight		
APPROVED	Ken	2025/08/13	PRODUCT NO.	232A-PSX00	
	SCALE	SHEET	SIZE	FILE NAME	
	10/1	2/3	A4	232A-PSX00_B_1	

REV.	DESCRIPTION	DRAWN	DATE
------	-------------	-------	------

A	B	C	D	E	F	G
JET BLACK SIMILAR RAL 9005	PURE WHITE SIMILAR RAL 9010	LIGHT BLUE SIMILAR RAL 5012	CLARET VIOLET SIMILAR RAL 4004	MAY GREEN SIMILAR RAL 6017	NUT BROWN SIMILAR RAL 8011	PLATINUM GREY SIMILAR RAL 7036
						
H	J	K	L	M	O	Z
LIGHT PINK SIMILAR RAL 3015	BEIGE SIMILAR RAL 1001	CURRY SIMILAR RAL 1027	YELLOW GREEN SIMILAR RAL 6018	PASTEL ORANGE SIMILAR RAL 2003	LIGHT GREEN SIMILAR RAL 6027	WATER BLUE SIMILAR RAL 5021
						



UNLESS OTHERWISE SPECIFIED TOLERANCE					
UNIT:	DECIMAL	LINEAR	ANGLES		
mm	X.	±0.50	±5°	www.attend.com.tw	
	X.X	±0.25	±3°		
	X.XX	±0.12	±1°		
DRAWN	Fros	2025/08/13	DRAWN NAME: HS-MTP Plug, Straight		
CHECKED	Tim	2025/08/13	PRODUCT NO. 232A-PSX00		
APPROVED	Ken	2025/08/13	FILE NAME 232A-PSX00_B_1		
	SCALE N/A	SHEET 3/3	SIZE A4		

REV.	DESCRIPTION	DRAWN	DATE
1	INITIAL RELEASE	FROS	2025/08/13

PACKAGING SPECIFICATION:

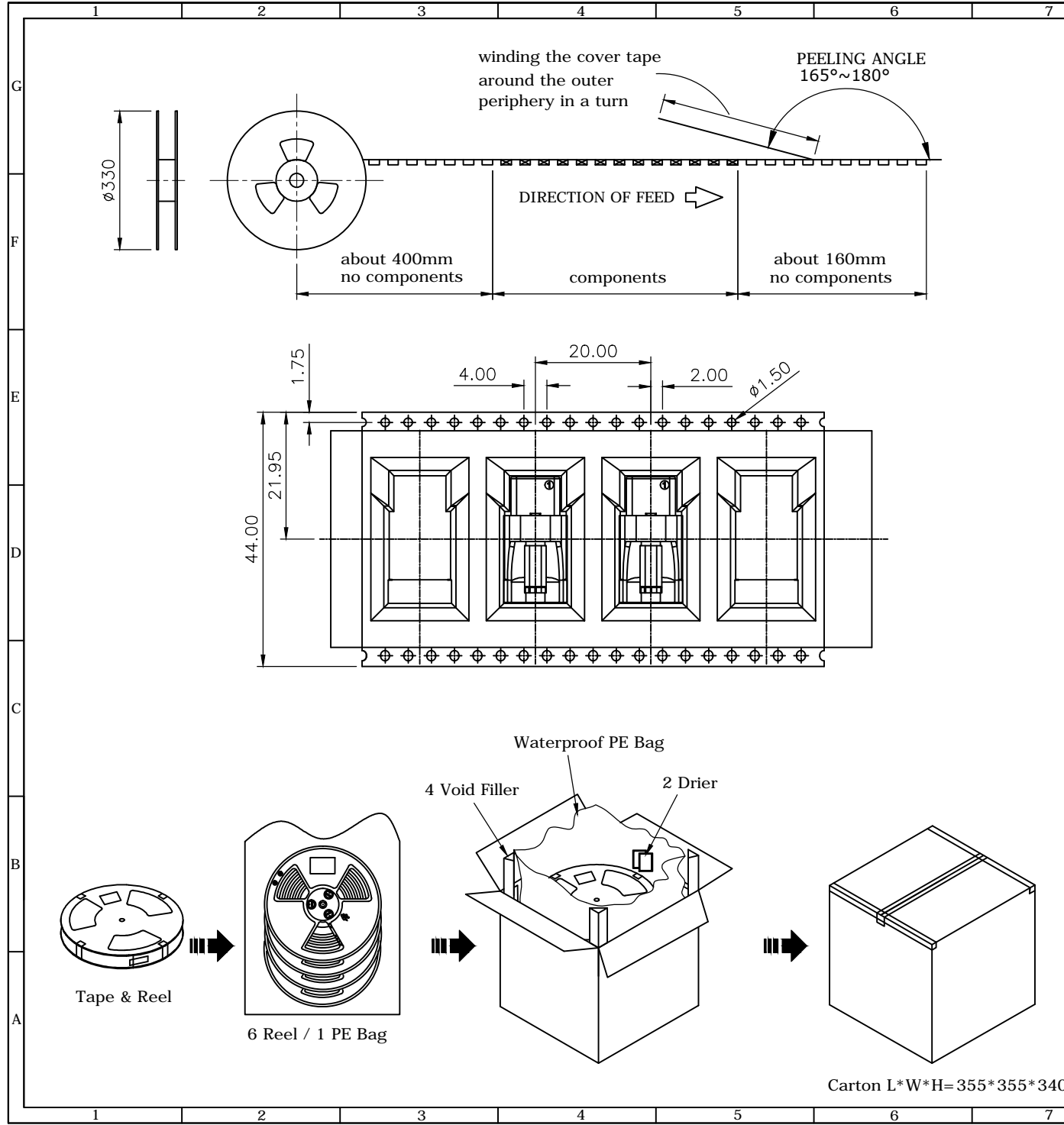
- 1. MATERIAL
 - 1.1 Embossed Carrier Tape: PS Black
 - 1.2 Top Cover Tape: PET
20-80g(Peel Speed 300mm/Minute)
 - 1.3 Taping Reel: Plastic
- 2. PACKING
 - 2.1 Quantity:
 - 180 Piece/Reel
 - 6 Reel/Carton
 - 1080 Piece/Carton



UNLESS OTHERWISE SPECIFIED TOLERANCE				 www.attend.com.tw
UNIT:	DECIMAL	LINEAR	ANGLES	
mm	X.	±0.50	±5°	
	X.X	±0.25	±3°	
	X.XX	±0.12	±1°	
DRAWN	Fros	2025/08/13	DRAWN NAME:	
CHECKED	Tim	2025/08/13	HS-MTP Plug, Straight	
APPROVED	Ken	2025/08/13	PRODUCT NO. 232A-PSX00	
	SCALE N/A	SHEET 1/1	SIZE A4	FILE NAME 232A-PSX00_D_1