

Data sheet | Item number: 2061-903

Board-to-Board Link; Pin spacing 6 mm; 3-pole; Length: 30 mm; white

www.wago.com/2061-903

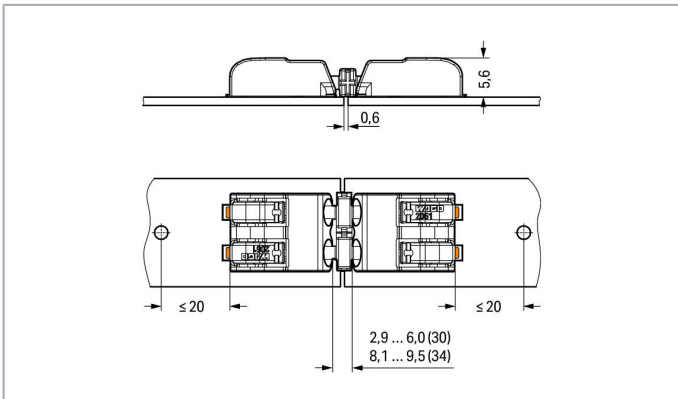
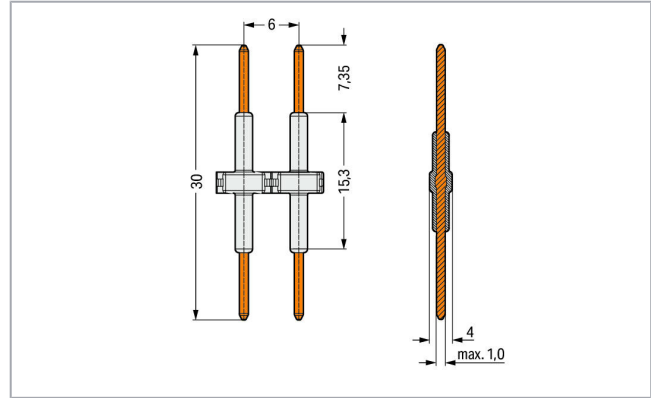
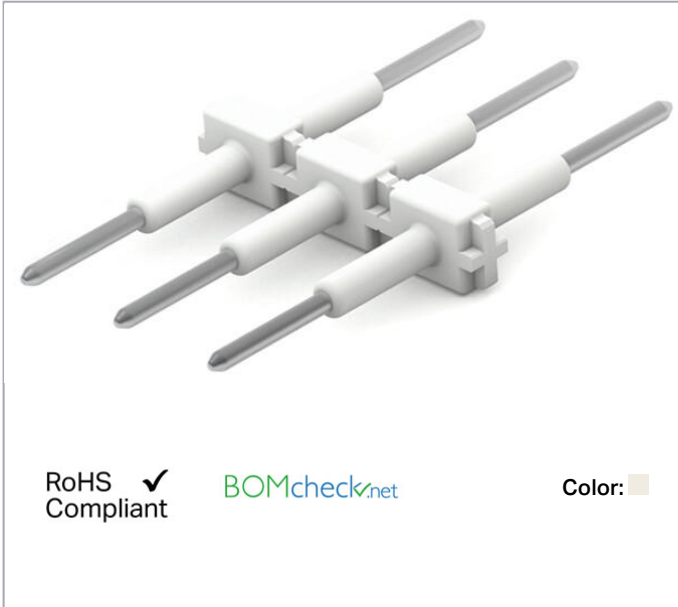

Item description

- Board-to-board links simplify in-line assembly of LED modules
- Easy push-in connection and disconnection without push-button actuation

Data

Electrical data

Subject to changes. Please also observe the further product documentation!

WAGO Kontakttechnik GmbH & Co. KG
Hansastr. 27
32423 Minden
Phone: +49571 887-0 | Fax: +49571 887-169
Email: info.de@wago.com | Web: www.wago.com

Do you have any questions about our products?
We are always happy to take your call at +49 (571) 887-44222.

Ratings per IEC/EN

Ratings per	IEC/EN 60664-1
Nominal voltage (III/3)	250 V
Rated surge voltage (III/3)	4 kV
Rated voltage (III/2)	320 V
Rated surge voltage (III/2)	4 kV
Nominal voltage (II/2)	630 V
Rated surge voltage (II/2)	4 kV
Rated current	9 A
Legend (ratings)	(III / 2) $\hat{=}$ Overvoltage category III / Pollution degree 2

Connection data

Pole No.	3
Total number of potentials	3

Physical data

Pin spacing	6 mm / 0.236 inch
Width	17.7 mm / 0.697 inch
Height	2.5 mm / 0.098 inch
Depth	30 mm / 1.181 inch

Mechanical data

Mating cycles (max.)	10
Number of mating cycles	max. 10 connections/disconnections
Suitable	for SMD PCB terminal blocks (2061 Series)

Material data

Color	white
Material group	I
Insulation material	Polyamide (PA66)
Flammability class per UL94	V0
Contact material	Copper alloy
Contact plating	silver-plated
Weight	0.8 g

Subject to changes. Please also observe the further product documentation!

Environmental requirements





Limit temperature range -60 ... +105 °C

Commercial data

Packaging type	BOX
Country of origin	CN
GTIN	4055143656801
Customs tariff number	85369010000

Approvals / Certificates

Country specific Approvals

Logo	Approval	Additional Approval Text	Certificate name
	CCA DEKRA Certification B.V.	EN 60838	NTR NL-7721
	CCA DEKRA Certification B.V.	EN 60947-7-4	NTR NL-7773
	KEMA/KEUR DEKRA Certification B.V.	EN 60838	71-106232
	KEMA/KEUR DEKRA Certification B.V.	EN 60947-7-4	71-110254

UL-Approvals

Logo	Approval	Additional Approval Text	Certificate name
	cURus Underwriters Laboratories Inc.	UL 1059	E45172

Subject to changes. Please also observe the further product documentation!

Downloads

Documentation

Additional Information

Technical explanations	3. 4. 2019	pdf 2.0 MB	Download
------------------------	------------	---------------	----------

CAD/CAE-Data

CAD data

2D/3D Models 2061-903	URL	Download
-----------------------	-----	----------

CAE data

ZUKEN Portal 2061-903	URL	Download
-----------------------	-----	----------

Environmental Product Compliance

Compliance Search

Environmental Product Compliance 2061-903 Board-to-Board Link; Pin spacing 6 mm; 3-pole; Length: 30 mm; white	URL	Download
--	-----	----------

Installation Notes

Installation

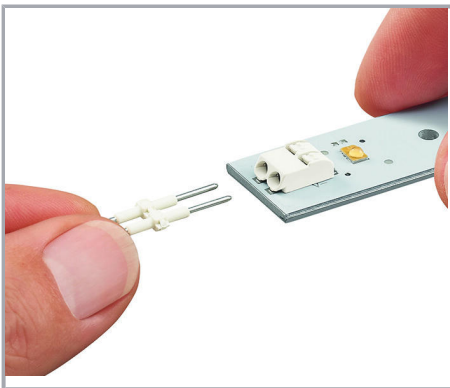

Inserting a board-to-board link into the terminal block.

Installation

Subject to changes. Please also observe the further product documentation!

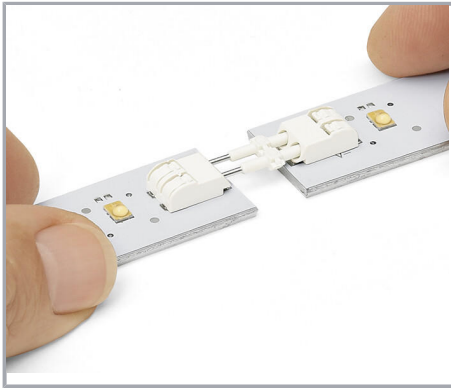

Assembly: Place PCBs on a flat surface and connect terminal blocks on adjoining PCBs via board-to-board link.

Disassembly: Pull PCBs apart (max. 10 mating cycles).

Installation

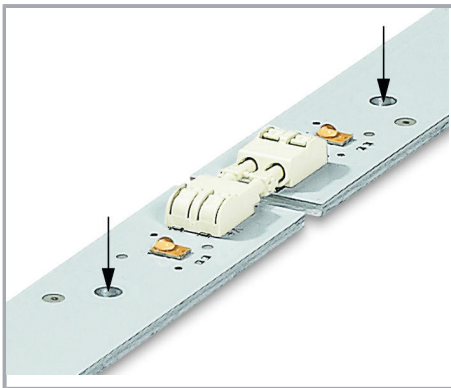

The PCBs must be secured.

Subject to changes. Please also observe the further product documentation!